

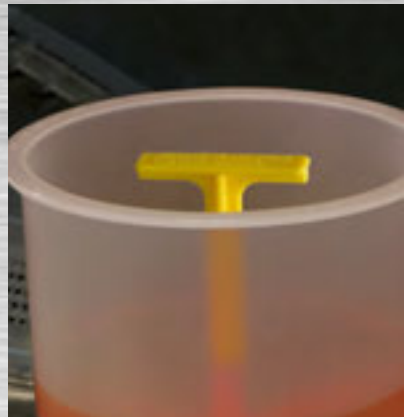

Lisle®

The Innovator in Specialty Tools



10000 10400 10500 BRAKE HONES

10000 3-Stone, Range 27/32" to 2".

10400 3-Stone Disc Brake Hone, Range 1-1/2" to 3-1/8".

10500 2-Stone Hone, Range 11/16" to 2-1/2".

Controlled pressure makes it possible to polish or hone with just one stone grit. Square ends of stones hone to the end in step-cut and blind-end cylinders. 220 grit stones are 1-1/8" long on 10000 & 10500; 400 grit 10400 stones are 1". Flexible driver provides good stability.

10000 Three-Stone Brake Cylinder Hone. Skin-packed. Shipping wt. 3 oz.

10050 Set Replacement Stones for 10000. Skin-packed. Shipping wt. 1 oz.

10400 Disc Brake Hone. Skin-packed. Shipping wt. 3 oz.

10490 Set Replacement Stones for 10400. Skin-packed. Shipping wt. 1 oz.

10500 Two-Stone Brake Cylinder Hone. Skin-packed. Shipping wt. 3 oz.

10550 Set Replacement Stones for 10500. Skin-packed. Shipping wt. 1 oz.

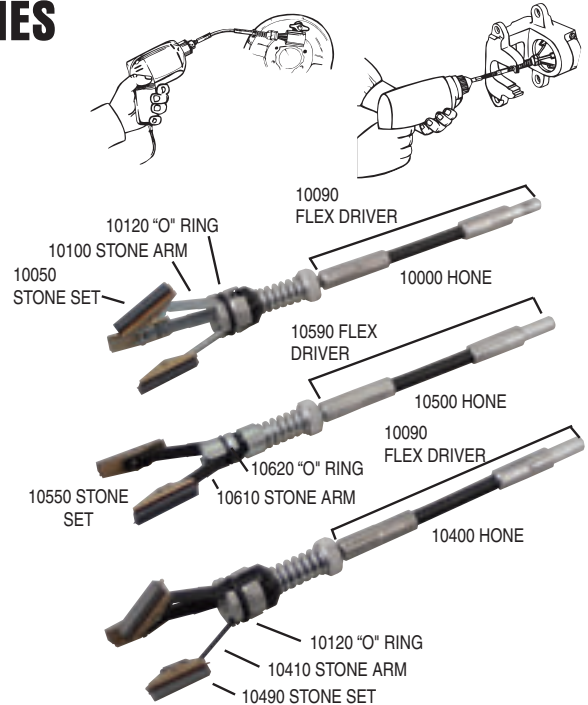

24300 SPEEDY BRAKE PAD SPREADER

25750 DUAL PISTON BRAKE PAD SPREADER

29100 QUICK QUAD PAD SPREADER

Compresses Brake Pistons in Seconds.

Compress disc brake pistons easily. Squeeze the handle and the fast acting plunger to compress disc brake pistons in seconds. 25750 Dual Piston Brake Pad Spreader compresses both pistons simultaneously. 29100 Quick Quad Pad Spreader simultaneously compresses all pistons on four piston brake calipers. Can be used while four piston caliper is still attached to the vehicle hub. Makes brake pad replacement a quick and easy job.

24300 Speedy Brake Pad Spreader. Hang Card. Shipping wt. 1 lb. 11 oz.

25750 Dual Piston Brake Pad Spreader. Hang Card. Shipping wt. 2 lbs. 3 oz.

29100 Quick Quad Pad Spreader. Hang Card. Shipping wt. 2 lbs. 13 oz.



24300 & 29100: U.S. Pat No. 6,874,217

25750: U.S. Pat No. 7,076,850

29100: U.S. Pat No. 8,393,063

24400 DISC BRAKE PAD SPREADER

For Installing Pads on Most Domestic and Import Cars and Light Trucks.

Makes changing pads an easy job. Tool compresses disc brake piston for easy pad installation.

24400 Disc Brake Pad Spreader. Skin-packed. Shipping wt. 11 oz.

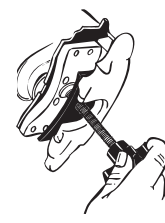

29350 COMBINATION DISC BRAKE KIT

One Tool Helps Make Installing New Pads on Front and Rear Brakes Quick and Easy.

Designed to work on single piston disc brakes that require the piston to be rotated back into the caliper as well as pistons that are pushed. Includes two, double-sided two pin adapters along with a pinless pushing adapter. Magnets and pins on back of pushing adapter allow use of other two pin adapters. Shaft may be rotated both directions depending on the vehicle application. Turn with 9/16" wrench or socket.

29350 Combination Disc Brake Kit. Blow Molded Case. Shipping wt. 2 lb. 3 oz.

25080 1-1/2" Adapter

25110 1-5/8" Adapter

29410 Pinless Adapter

Applications:

Adapter 1A - 1-1/2" (narrow pins) most Hondas, Mazdas, Dodge, Mitsubishi and 1-1/2" GMs

Adapter 1B - 1-1/2" (wide pins) most Fords, Toyotas and some Pontiac

Adapter 2A - 1-5/8" most Nissans/Datsuns and Subarus

Adapter 2B - 1-5/8" Mazda 3, some Jaguar and some Mini Cooper

Pinless Adapter - Front brakes that do not require the piston to be rotated back into the caliper



YouTube

25000 UNIVERSAL DISC BRAKE CALIPER TOOL

For Rotating the Brake Piston Back Into the Caliper to Provide Clearance for New Pads. New Second Side on Adapter 2B 1-5/8" Has Narrow Pins to Fit Mazda 3 Applications.

Includes 5 adapters (available individually) for use in both 2 and 4-wheel disc brake assemblies of most domestic and import cars. Tool may be used "on" or "off" the car. A real time saver that makes this tough job easy. Helps prevent damage to the piston and boot.

NOTE: Some pistons turn clockwise while others turn counter-clockwise; consult your shop manual for the car you are servicing. For the counter-clockwise rotation the 1" Hex Nut must be turned at a faster rate of rotation in order to keep the adapter engaged with the piston.

25000 Universal Disc Brake Caliper Tool. Molded Case. Shipping wt. 5 lbs.

25040 Backing Plate.

25080 1-1/2" Adapter.

25110 1-5/8" Adapter.

25130 1-7/8" Adapter.

25150 2-1/8" Adapter.

25170 2-1/2" Adapter.



25110 - SIDE (2B) FITS MAZDA 3, SOME MINI COOPER AND SOME JAGUAR APPLICATIONS

28600 DISC BRAKE PISTON TOOL

Rotates Piston Back Into the Caliper When Replacing Pads.

A sixth side has been added and one side has been modified. This tool now fits more applications. Used on vehicles with four wheel disc brakes. Fits most domestic and some import applications. Push and turn tool to rotate piston into caliper. Use with 3/8" drive ratchet and extension.

28600 Disc Brake Piston Tool. Skin-packed. Shipping wt. 4 oz.

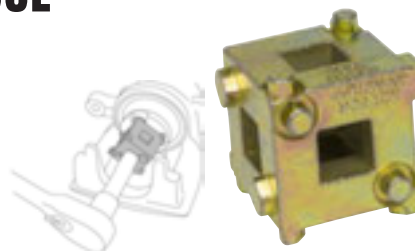

6 DIFFERENT PISTON CONFIGURATIONS

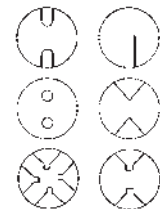

U.S. Pat No. 6,029,550

29150 UNIVERSAL BRAKE CALIPER BIT SET

Nine Sizes for Brake Caliper Bolt Applications.

Set includes four Torx® and five hex bits for removal and installation of brake caliper mounting bolts. Includes the following sizes: T-40, T-45, T-47, T-50, 1/4", 3/8", 7mm, 8mm and 10mm. All bits are 3/8" square drive. Handy vinyl holder keeps bits together in one place. All bits available individually.

29150 Universal Brake Caliper Bit Set. Skin-packed. Shipping wt. 15 oz.

Part#	Size
13650	1/4"
13670	3/8"
26620	T-40
26630	T-45
26500	T-47
26640	T-50
33900	7mm
33910	8mm
33920	10mm

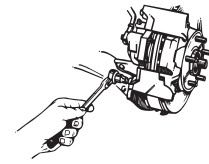

12550 BRAKE CALIPER BIT SET

For Servicing Disc Brakes.

Three 3/8" square drive sockets with hex bits to remove and replace floating caliper mounting bolts. 3/8" and 8mm hex bits for GM and 1/4" hex bit for Ford. Also available individually.

12550 Brake Caliper Socket Set. Skin-packed. Shipping wt. 7 oz.

12450 1/4" Brake Caliper Socket. Skin-packed. Shipping wt. 2 oz.

12560 8mm Brake Caliper Socket. Skin-packed. Shipping wt. 2 oz.

12570 3/8" Brake Caliper Socket. Skin-packed. Shipping wt. 2 oz.

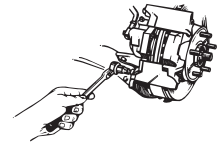

33900 33960 33920 7MM, 9MM, 10MM HEX BRAKE CALIPER BITS

For Removing and Installing Disc Brake Calipers.

Hex bits remove and install floating caliper mounting bolts. 7mm hex is used for some Chrysler, Audi, Ford, Jeep, Lincoln and Volkswagen applications. 9mm hex fits Ford Expedition '06-'08, Ford Escape '06, Mercedes ML320 CDI and other vehicles. 10mm hex is used for some Chevrolet and GMC van and truck applications. Use with 3/8" drive.

33900 7mm Hex Brake Caliper Bit. Skin-packed. Shipping wt. 2 oz.

33920 10mm Hex Brake Caliper Bit. Skin-packed. Shipping wt. 2 oz.

33960 9mm Hex Brake Caliper Bit. Skin-packed. Shipping wt. 2 oz.

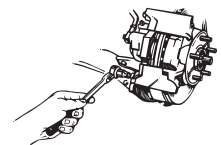

27740 BRAKE CALIPER TORX® BIT SET

T-40, T-45, T-50 Sizes for Servicing Disc Brakes.

Three 3/8" square drive Torx bits to fit GM and Ford brake caliper Torx bolts. Also available individually.

27740 Brake Caliper Torx Bit Set. Skin-packed. Shipping wt. 5 oz.

26620 T-40 Torx Bit. Skin-packed. Shipping wt. 2 oz.

26630 T-45 Torx Bit. Skin-packed. Shipping wt. 2 oz.

26640 T-50 Torx Bit. Skin-packed. Shipping wt. 2 oz.

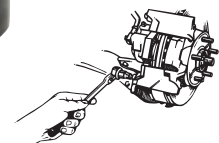

22850 HOSE PINCHERS

A quick, easy way to pinch off vacuum lines, fuel lines, brake lines, etc. without damaging the line. Sold two per set.

22850 Hose Pinchers. Skin-packed. Shipping wt. 5 oz. (2 per set)



50600 SINGLE-SPRING BRAKE TOOL

Modified Bracket Now Fits 2007 Silverado/ Sierra Applications.

Releases Tension on Both Large and Small GM Single Spring Brakes During Servicing. Many GM brakes use a heavy single spring. The 50600 engages the spring and quickly releases the spring tension. The brake can then be disassembled to replace brake shoes, emergency brake cable or service the brake cylinder. Also works on older C & H body vehicles with single brake springs.

50600 Single-Spring Brake Tool. Shipping wt. 1 lb. 8 oz.

50150 Bracket - Updated Requires 2

Applications

Smaller Spring 1991 to current GM H Body Bonneville, LaSabre Delta, 88	Larger Spring 2005 to current Chevrolet Silverado 2004 to current Chevrolet Colorado Includes 2007 Models
1995 to current Chevrolet Lumina & Monte Carlo 1992 to current GM C & H Body Buick Electra Olds 88 Cadillac Fleetwood Cadillac DeVille Chevrolet Lumina APV Pontiac Trans Sport Olds Silhouette	

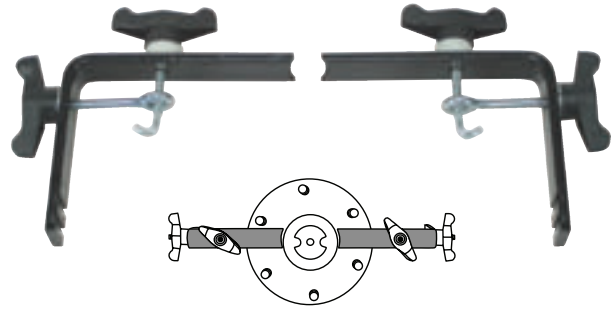

2007 SILVERADO HUB

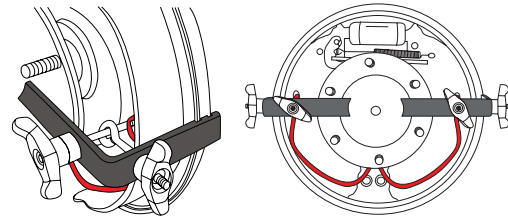

U.S. Pat No. 7,032,280

49100 T-HANDLE SINGLE SPRING BRAKE TOOL

Quickly and Easily Releases Tension on Large and Small Single Spring Brakes on GM Vehicles.

The tool design uses the hook to grab onto the spring while the tool tip is used as a fulcrum to pry the spring free. The tool can also be used to re-install the spring.

49100 T-Handle Single Spring Brake Tool. Skin-packed. Shipping wt. 16 oz.

49140 Replacement Hook and Bolts



YouTube

U.S. Pat No. 8,707,533

47400 BRAKE SPRING WASHER TOOL

Fits Both Large and Small Washers.

Troublesome brake shoe retaining spring washers can now be easily removed and then reinstalled. Wide "window" allows better visibility to align the nail and washer slot.

47400 Brake Spring Washer Tool. Skin-packed. Shipping wt. 4 oz.

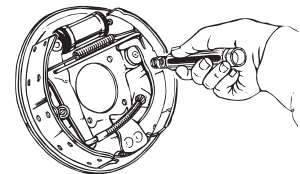
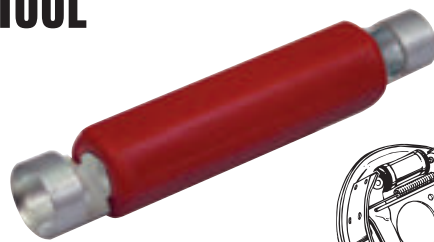

48400 IMPORT CAR BRAKE CLIP TOOL

Designed for Import Cars with Brake Shoe Hold-down Clips.

Removes and installs the brake clip and nail on brake shoes in seconds. Set tool head in the brake clip groove. Push tool to depress brake clip. Turn handle 1/4 turn to disengage clip from nail. Reverse to install.

48400 Import Car Brake Clip Tool. Skin-packed. Shipping wt. 5 oz.



IMPORT CAR
HOLD DOWN CLIP

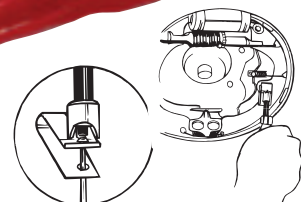

11260 BRAKE SPRING PLIERS

Double Ended Tool for Removing and Installing Brake Springs.

Use plier tips to stretch brake spring. Handle ends remove and install spring over anchor post.

11260 Brake Spring Pliers. Skin-packed. Shipping wt. 16 oz.

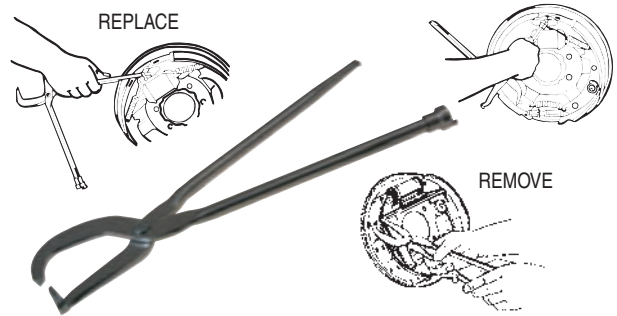

46750 BRAKE SPRING TOOL

Makes it Easy to Remove and Replace Springs.

A spring tool for removing and replacing brake return springs that are set over a post. Heat-treated end fitting engages hook and removes it from the post when the tool is turned clockwise. "Shoe horn" design on the other end makes it easy to slip the spring back over the post. Large handle gives good grip and easy operation.

46750 Brake Spring Tool. Skin-packed. Shipping wt. 6 oz.

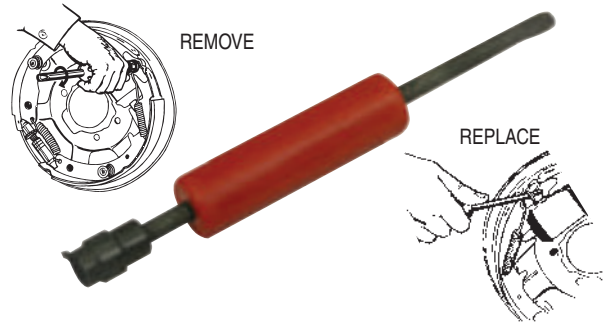

45100 BRAKE SPRING TOOL

Designed for Import Car Brake Return Springs.

This tool removes and installs import brake return springs. Also works on domestic brakes that don't use an anchor pin. Engage brake spring in tool head. Turn handle to lock on spring. Expand spring to install or remove.

45100 Brake Spring Tool. Skin-packed. Shipping wt. 4 oz.

45140 Tip

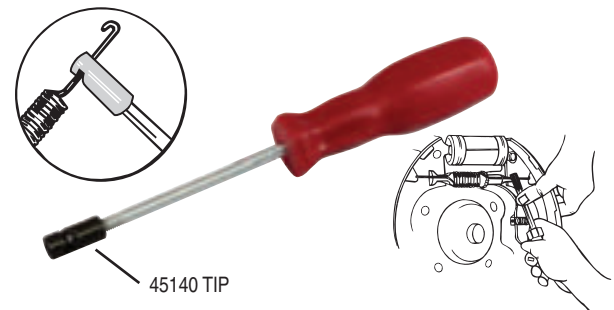

44800 HEAVY-DUTY BRAKE SPRING TOOL

Designed for Larger Brake Springs.

The heavy-duty tool removes and installs larger brake return springs. Works on brakes with or without an anchor pin. Engage brake spring in tool head. Turn rear handle to lock on spring. Expand spring to install or remove. Front handle can be removed when working in tight places.

44800 Heavy-Duty Brake Spring Tool. Skin-packed. Shipping wt. 8 oz.

44810 Tip

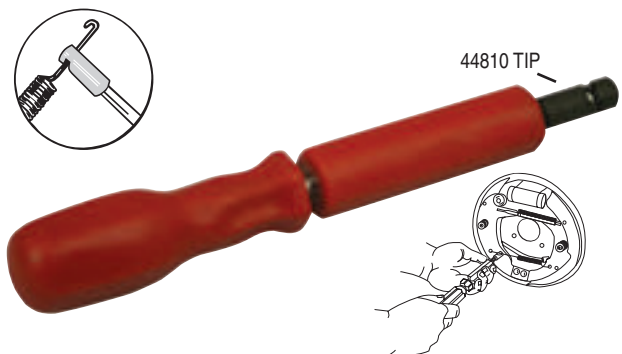

19200 BRAKE BLEEDING KIT

Simple to Use.

Everything needed to quickly bleed brakes with no mess. Plastic bottle collects discharged fluid. Three separate adapters fit the common bleeder screws.

19200 Brake Bleeder. Skin-packed. Shipping wt. 5 oz.

73090 No. 1 Adapter

73100 No. 2 Adapter

73110 No. 3 Adapter



50700 BRAKE ADJUSTMENT TOOL

Speeds Star Wheel Adjusting.

Insert tool through slot in backing plate. Different angle at each end adapts to various makes and models.

50700 Brake Adjustment Tool. Skin-packed. Shipping wt. 2 oz.



40750 PARKING BRAKE CABLE REMOVER

Allows Technician to Remove Parking Brake Cable by Compressing the Spring.

Tool can be used when cable is still attached to parking brake assembly. Ends of tool are angled to allow easier access. Slots on each end allow tool to slip over cable instead of feeding the cable through the end of the tool. Especially useful on Ford F-Series, Expeditions, Excursions, etc.

40750 Parking Brake Cable Remover. Skin-packed. Shipping wt. 5 oz.



10900 10950 10990 11000 BRAKE BLEEDER WRENCHES

For Bleeding Air From Brake Cylinders With Bleeder Screws.

Double ended tools are offset for easy access.

10900 for 5/16" or 3/8" bleeder screws.

10950 for 1/4" or 3/8" bleeder screws.

10990 for 7mm or 9mm bleeder screws.

11000 for 8mm or 10mm bleeder screws.

10900 5/16" - 3/8" Brake Bleeder Wrench. Skin-packed. Shipping wt. 4 oz.

10950 1/4" - 3/8" Brake Bleeder Wrench. Skin-packed. Shipping wt. 4 oz.

10990 7mm - 9mm Brake Bleeder Wrench. Skin-packed. Shipping wt. 4 oz.

11000 8mm - 10mm Brake Bleeder Wrench. Skin-packed. Shipping wt. 4 oz.

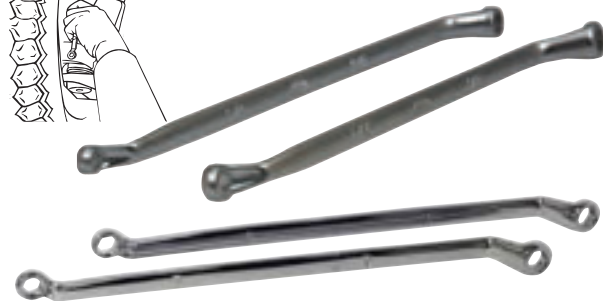

81850 COMBINATION BRAKE LINING THICKNESS GAUGE SET

The 9 Piece Manual Brake Gauge Set Allows Brake Pad Wear to be Accurately and Consistently Measured without Guessing.

Designed to check both straight on or at a 90° angle to the rotor with offset tips so the gauges can be used without removing the wheel or caliper assembly on many applications. Brake lining gauges identify thickness levels for brake lining inspection. Made from durable, flexible acetal. The gauges are color coded to match SAE or Metric recommendations for brake pad replacement. Green (Good): 12mm (.4724"), 10mm (.3937"), 8mm (.3150"). Yellow (Marginal): 6mm (.2362"), 5mm (.1969"), 4mm (.1575"). Red (Replace): 3mm (.1181"), 2mm (.0787").

81850 Combination Brake Lining Thickness Gauge Set. Hang Card. Shipping wt. 2 oz.

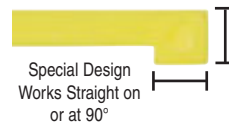

Gauges Included:
81860 2mm 90°
81870 2mm Straight
81880 3mm
81890 4mm
81900 5mm
81910 6mm
81920 8mm
81930 10mm
81940 12mm



U.S. Pat No. 9,500,462

44210 UNIVERSAL EMERGENCY BRAKE TOOL

Allows Technicians to Compress the Emergency Brake Cable Spring with One Hand.

Keeps one hand free for brake shoe arm or lever replacement.

44210 Universal Emergency Brake Tool. Skin packed. Shipping wt. 6 oz.



44220 EMERGENCY BRAKE CABLE RELEASE TOOL

Quickly and Easily Pushes the Emergency Brake Cable Out of the Cable Connector for Rear Brake Service or Replacement.

The tool can be used on many domestic and import vehicles with an emergency brake cable at the rear wheels. Works on drum brake applications as well as vehicles with rear disc brakes.

44220 Emergency Brake Cable Release Tool. Skin packed. Shipping wt. 7 oz.



71020 MASTER BRAKE TOOL KIT

A Handy Set of 12 Brake Tools for Use When Servicing Many Drum Brake Applications.

Includes tools for removing and installing brake springs along with parking brake and star wheel adjusting tools. Color coded brake lining gauges for accurate measurement of brake shoe lining. Packaged in a Lisle branded tool bag.

71020 Master Brake Tool Kit. Laminated Card. Shipping wt. 5 lbs. 1 oz.

11260 Brake Spring Pliers

13410 Brake Caliper Brush

40750 Parking Brake Cable Remover

44210 Universal Emergency Brake Tool

44220 Emergency Brake Cable Release Tool

44800 Heavy-Duty Brake Spring Tool

46750 Brake Spring Tool

47400 Brake Spring Washer Tool

48400 Import Car Brake Clip Tool

49100 T-Handle Single Spring Brake Tool

50700 Brake Adjustment Tool

71040 Tool Bag

81850 Combination Brake Lining Thickness Gauge Set



13410 BRAKE CALIPER BRUSH

Cleans Brake Caliper Mounting Surfaces.

Removes brake dust, rust and other debris from brake caliper castings. Brush is made with heavy-duty steel wire and is angled to fit into tight places. Brush comes with molded handle grip for easy use.

13410 Brake Caliper Brush. Skin-packed. Shipping wt. 3 oz.



14000 PARTS CLEANING BRUSH

Removes Dirt and Grease From Motors, Machinery and Metal Parts.

Polypropylene bristles hold up under repeated use in cleaning solvents.

14000 Parts Cleaning Brush. Skin-packed. Shipping wt. 5 oz.



14020 2-1/2" WIRE CUP BRUSH

Removes Weld Scale, Rust, Paint and Corrosion From Metal Surfaces.

Brush also gives an excellent surface for painting. Made with .014 carbon steel wire and designed for light duty use with an electric drill. Maximum safe free speed is 4500 RPMs.

14020 2 1/2" Wire Cup Brush. Skin-packed. Shipping wt. 5 oz.



14040 14060 1" WIRE END BRUSHES

For Light to Heavy Duty Work.

Made with .020" industrial heat tempered wire. Use with portable electric and air tools. 20,000 RPM maximum safe free speed. 14040 knot end brush for heavy duty use. Excellent for baked on gaskets. 14060 crimped end brush for light to heavy work. Cleans dirt and carbon from metal surfaces.

14040 1" Knot Wire End Brush. Skin-packed. Shipping wt. 4 oz.

14060 1" Crimped Wire End Brush. Skin-packed. Shipping wt. 4 oz.



KNOT STYLE

14040

14060

CRIMPED STYLE

14160 14180 SCRATCH BRUSHES

Removes Rust, Scale, Paint and Solder From Metal Surfaces.

Also great for cleaning threads and files. 14160 has 5-1/2" of densely packed wire bristles and a hardwood handle. Overall length is 14". 14180 has 4-1/2" of densely packed wire bristles and a hardwood handle. Overall length 9-3/4".

14160 Scratch Brush. Skin-packed. Shipping wt. 7 oz.

14180 Shoe Handle Wire Scratch Brush. Skin-packed. Shipping wt. 7 oz.



14160

14180

41500 PICKLE FORK KIT

For Separating Ball Joints, Tie Rods, Pitman Arms and Other Uses.

Six tools in one for exceptional versatility and value. Kit consists of three forks and two handles; one for hammering, the other for use with an air hammer (.401" shank). All forks are threaded to interchange with either handle. Forks are heavy-duty forgings.

41500 Pickle Fork Kit. Clam Shell Package. Shipping wt. 3 lbs. 15 oz.

41510 Handle	41520 Pneumatic Driver	41530 1-1/8" Fork
41540 15/16" Fork	41550 11/16" Fork	



41400 STEPPED PICKLE FORK KIT

Step Design Helps Keep Tool from Bouncing Back When Separating Ball Joints, Steering Dampeners, Tie Rods, Pitman Arms and Other Applications.

Six tools in one. Three forks and two handles. Forks are threaded to interchange with either handle. One handle for hammering; one for use with an air hammer (.401" shank). Forks are heavy-duty heat-treated, alloy steel forgings. Steps can be sharpened if needed.

41400 Stepped Pickle Fork Kit. Clam Shell Package. Shipping wt. 3 lbs. 13 oz.

41410 1-1/8" Stepped Fork	41420 11/16" Stepped Fork
41430 15/16" Stepped Fork	41510 Handle
41520 Pneumatic Driver	



41440 STEPPED PICKLE FORK KIT, 5 PC.

Step Design on the Forks Keeps the Tool from Bouncing Back when Separating Ball Joints, Steering Dampeners, Tie Rods, Pitman Arms and Other Applications.

Includes five forks: 11/16", 15/16", 1-1/8", 1-7/16" and 1-5/8". The forks are threaded to interchange with either the handle for hammering or the pneumatic driver. The forks are heavy-duty, heat-treated forgings and the handles are heat-treated alloy steel. The fork steps can be sharpened if needed.

41440 Step Pickle Fork Kit, 5pc. Molded Case. Shipping wt. 6 lbs. 8 oz.

41370 1-5/8" Stepped Fork	41380 1-7/16" Stepped Fork
41410 1-1/8" Stepped Fork	41420 11/16" Stepped Fork
41430 15/16" Stepped Fork	41510 Handle
41520 Pneumatic Driver	



41220 THICK PICKLE FORK KIT, 5 PC.

The Thicker Fork Design Provides Extra Lift.

The set includes five forks: 11/16", 15/16", 1-1/8", 1-7/16" and 1-5/8". The forks are threaded to interchange with either the handle for hammering or the pneumatic driver (.401 Shank) and a 6-1/4" extension that works with either handle to provide extra reach.

41220 Thick Pickle Fork Kit. Molded Case. Shipping wt. 8 lbs.

41510 Handle	41520 Pneumatic Driver	41470 Long Extension
41200 1-5/8" Fork	41190 1-7/8" Fork	41180 1-1/8" Fork
41170 15/16" Fork	41160 11/16" Fork	



REGULAR FORK

FORK IS 1/2" THICKER



18520 STEPPED TIE ROD SEPARATOR

18530 STEPPED BALL JOINT SEPARATOR

Step Design Helps Keep Tool from Bouncing Back.

18520 is used to replace worn out tie rods and to separate shock absorber links. The tine opening is 11/16". The 18530 is used to replace worn out ball joints and to remove CV drive shafts on FWD vehicles. The tine opening is 15/16". These heavy-duty tools are drop forged and heat-treated for long use. Steps can be sharpened if needed.

18520 Stepped Tie Rod Separator. Skin-packed. Shipping wt. 1 lb. 11 oz.

18530 Stepped Ball Joint Separator. Skin-packed. Shipping wt. 1 lb. 12 oz.



41900 PITMAN ARM PULLER

Heavy Duty Puller Works on Most Cars and Trucks.

Designed to work on even the most stubborn Pitman arm pulling jobs. Position puller jaws over Pitman arm and turn center screw to free Pitman arm. Puller body is drop-forged and heat-treated for strength.

41900 Pitman Arm Puller. Skin Packed. Shipping wt. 2 lbs. 1 oz.

41910 Puller Screw

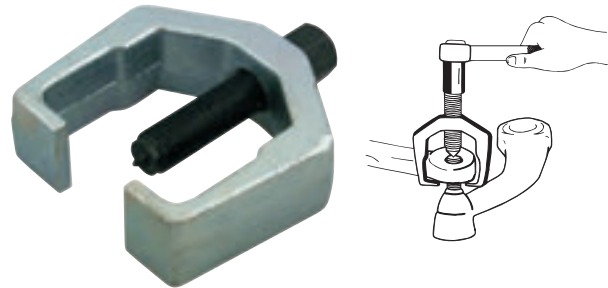

41970 HEAVY-DUTY PITMAN ARM PULLER

For 2005 and Later Ford F250 & F350.

A heavy-duty puller for the large Pitman arms on Ford 250 and 350 trucks. Jaws are forged and heat-treated for strength. Position puller jaws under the Pitman arm, turn center screw to remove.

41970 Heavy-Duty Pitman Arm Puller. Skin Packed. Shipping wt. 3 lbs.

41910 Puller Screw

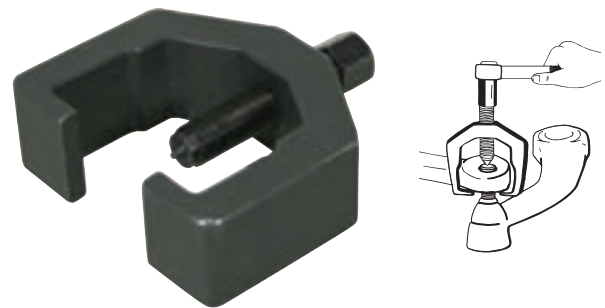

38210 HUB REMOVER KIT FOR DODGE

Separates the Frozen Hub Assembly from the Steering Knuckle on Dodge Vehicles.

Tool drives against loosened retaining bolts to separate assembly. Prevents damage to the knuckle and complete hub assembly. Tool drives on the bolt flange, so the head of the retaining bolt is not destroyed. Kit contains 39300 for older, smaller applications and 39250 for 2003 and newer 4-wheel drive 3/4 ton and 1 ton Dodge pickups. Available individually.

38210 Hub Remover Kit for Dodge. Skin-packed. Shipping wt. 13 oz.

39250 Hub Remover 03-09 Dodge. Mini-pouched.

39300 Front Hub & Knuckle Separator. Skin-packed.



46800 MASTER INNER TIE ROD KIT

Includes Nine Crows Feet in a Handy Molded Storage Case.

Works on tie rods with inaccessible flats. Many inner tie rod end sockets do not have a complex hex on the full length of the socket. The rounded socket ends prevent access to the wrench flats. This tool utilizes nine crows feet to engage the wrench flats. Long socket slips over tie rod end and connects to the crows foot. The inner tie rod can be removed and installed without removing the rack.



46800 Inner Tie Rod Tool. Molded Case. Shipping wt. 5 lbs.

45770 Socket	45810 Retainer
45670 33.6mm Crowfoot	45700 1-3/16" Crowfoot
45820 1-7/16" Crowfoot	45830 1-5/16" Crowfoot
45840 1-1/4" Crowfoot	46160 1-1/2" Crowfoot
46270 29mm Crowfoot	46280 32.5mm Crowfoot
46300 1-3/8" Crowfoot	

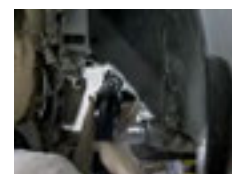

45750 INNER TIE ROD TOOL

Includes an Additional 1-1/2" Crows Foot for Chevrolet Colorado and GMC Canyon.

Works on tie rods with inaccessible flats. The rounded socket ends prevent access to the wrench flats. This tool utilizes six crows feet to engage the wrench flats. Long socket slips over tie rod end and connects to the crows foot. The inner tie rod can be removed and installed without removing the rack.

45750 Inner Tie Rod Tool. Clam Shell Package. Shipping wt. 3 lbs. 6 oz.

45770 Socket	45810 Retainer
45670 33.6mm Crowfoot	45700 1-3/16" Crowfoot
45820 1-7/16" Crowfoot	45830 1-5/16" Crowfoot
45840 1-1/4" Crowfoot	46160 1-1/2" Crowfoot

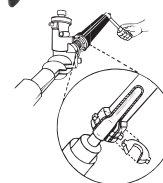

54500 LARGE INNER TIE ROD TOOL

Works On Inner Tie Rods With Inaccessible Wrench Flats On Many Trucks and SUVs.

The long socket slips over tie rod end and crows foot engages on socket for easy removal and installation. This tool comes with five crows feet, sizes 1-7/16", 33.6mm, 38.4mm, 40mm and 42mm, to fit many Toyota, Nissan, Ford, Lincoln, Mercury and Chevrolet truck and SUV applications. Also fits some Cadillac Escalade, Hummer H2, Honda Passport and Jeep Liberty applications.

54500 Large Inner Tie Rod Tool. Boxed. Shipping wt. 3 lbs. 4 oz.

54490 40mm Crowfoot	54510 Socket	54550 Retainer
54560 33.6mm Crowfoot	54570 1-7/16" Crowfoot	
54580 38.4mm Crowfoot	54590 42mm Crowfoot	

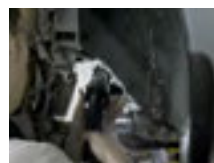

46600 UNIVERSAL INNER TIE ROD WRENCH

Removes Inner Tie Rods Equipped with a Completely Round End Socket or with Flats.

Designed to remove and install all inner tie rod sockets up to 1-31/64". The wrench head has three set screws that tighten against the rounded tie rod socket or socket flats. Comes with a 1/4" short head hex wrench for tightening set screws in hard-to-reach areas. No-flat applications include: '00-'03 Dodge Neon, '00-'01 Plymouth Neon, and '01-'03 Dodge & Chrysler Minivans.

Also fits some no-flat applications on Ford & Nissan.

46600 Universal Inner Tie Rod Wrench. Skin-packed. Shipping wt. 2 lbs. 7 oz.

46570 1/4" Short Head Hex Key 46620 1/2-20 Socket Head Set Screw



SUSPENSION

43620 BALL JOINT / TRUCK BRAKE ANCHOR PIN / U-JOINT PRESS

Tough Tool Makes Easy Work of Three Different Jobs.

Removes and installs press fit type ball joints found on cars and light trucks. Tool makes removing and installing truck brake anchor pins fast and easy. Also works on u-joints to press joint from the drive shaft for replacement. Tool comes with detailed instructions and a heavy-duty plastic storage case.

43620 Ball Joint / Truck Brake Anchor Pin / U-Joint Press. Boxed.

Shipping wt. 16 lbs. 1 oz.

43670 Screw Assembly 43680 Frame Adapter

43690 Screw Adapter 43700 3" Tube

43710 2-1/2" Tube 43720 2" Tube



U-JOINT REMOVAL

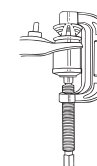
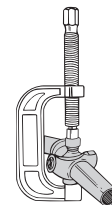

BALL JOINT REMOVAL

REMOVAL OF ANCHOR PINS



62300 STRUT TOOL

Safe - Universal - Inexpensive.

This is an inexpensive, but super safe strut spring compressor. Fits all strut spring sizes, import and domestic. Heavy duty clamps and bolts securely hold spring during operation.

62300 Strut Tool. Clam Shell. Shipping wt. 5 lbs. 13 oz.

62350 Bolt 62360 Nut

62370 Washer 63240 U-Bolt

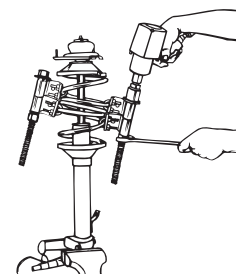

20400 SHOCK ABSORBER TOOL

For Removing and Installing Shock Nuts.

Fits most domestic models and some Ford OEM shock nuts. Place stem socket over shock stem. Hex nut socket fits the nut. Hold one, turn the other for removal.

20400 Universal Shock Absorber Tool. Skin-packed. Shipping wt. 9 oz.

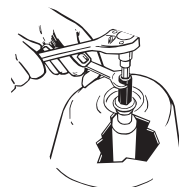

HEX NUT SOCKET
STEM SOCKET

12800 MASTER PNEUMATIC BEARING RACE & SEAL DRIVER SET

This Master Set Contains 11 Drivers to Fit Automobiles and Trucks up to 1 Ton.

This set also includes 2 handles, one for hammering and a pneumatic handle for use with an air hammer. Use the tapered driver side for bearing races; reverse to the flat side for seals. To add the pneumatic handle to your current set order a 12820 pneumatic driver. Molded case.

12800 Master Pneumatic Bearing Race & Seal Driver Set. Molded case.

Shipping wt. 6 lbs. 11 oz.

12820 Pneumatic Handle 12730 Handle

*FOR HEAVY-DUTY APPLICATIONS SEE 61900, Pg. 77

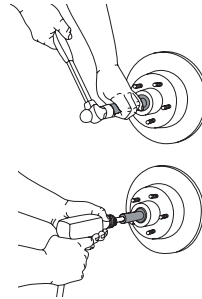

Driver No.	Size
12610	1.565"
12620	1.750"
12630	1.965"
12640	2.325"
12650	2.555"
12690	2.830"
12700	2.995"
12710	2.470"
12810	4.625"
12930	3.813"
12970	3.180"

U.S. Pat No. 7,707,709

12600 12980 BEARING RACE AND SEAL DRIVER SETS

Makes it Easier to Insert Bearing Race.

Insert bearing race quickly, straight in on FIRST TRY! Helps reduce damage to both race and axle housing. Turn driver over to drive seals.

12600 Bearing Race Driver. Includes 6 drivers. Clam Shell Package. Wt. 1 lb. 9 oz.

12980 Bearing Race and Seal Driver. Includes 9 drivers. Molded Case. Wt. 3 lb.

12660 Handle

MEASUREMENTS ARE TO OUTSIDE OF DRIVERS.

Driver No.	Size
12610	1.565"
12620	1.750"
12630	1.965"
12640	2.325"
12710	2.470"
12650	2.555"
12690	2.830"
12700	2.995"
12970	3.180"

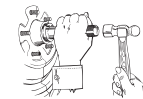

*There are 9 Drivers. The first 6 are included in the 12600. The largest 3 are available individually or in the 12980 Master Set.

59400 PINION BEARING RACE DRIVER SET

Set Includes 8 Drivers for Driving Inner and Outer Pinion Bearing Races on 1/2 & 3/4 Ton Ford, Dodge and GM Pickups.

Use the extended, two-piece handle for driving rear pinion bearing races. A pneumatic handle is also included for use with an air hammer.

59400 Pinion Bearing Race Driver Set. Molded case. Shipping wt. 7 lbs. 6 oz.

12820 Pneumatic Handle 59540 Handle

59530 Handle Extension (with Tapped Hole)

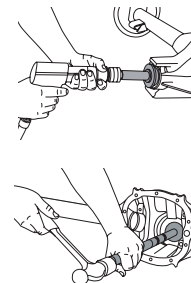

Driver No.	Size
59410	2-11/16"
59420	2-27/32"
59430	2-7/8"
59440	3"
59450	3-1/4"
59460	3-1/2"
59470	3-3/4"
59480	4-1/8"

U.S. Pat No. 7,707,709

24800 SEAL DRIVER KIT

Quickly Drives Seals Without Damage.

Sixteen adapters for seals up to 3-3/8" diameter. Includes special adapters for "shielded" seals.

24800 Seal Driver. Clam Shell Package. Shipping wt. 1 lb. 11 oz.

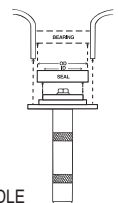

SET INCLUDES 16 ADAPTERS, ONE WASHER AND ONE HANDLE

21600 RIGHT ANGLE GREASE GUN ADAPTER

Reach Inaccessible Grease Zerks.

Attach to any standard grease gun to reach confined areas. For Chrysler, Dodge and Plymouth FWD ball joints and other tight places.

21600 Right Angle Grease Gun Adapter. Skin-packed. Shipping wt. 5 oz.

21620 Piston

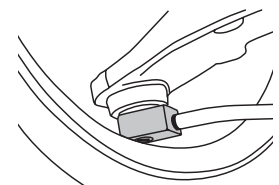

34550 HANDY PACKER® BEARING PACKER

Quickly Flushes Out Old Grease and Repacks Bearings with Less Mess.

The Handy Packer works on bearings up to 3-1/2" O.D. The grease stays in the tool cavity, not on your hands. To pack a bearing, place the bearing on the piston. Press down on the cap until the old grease is forced out and the new grease shows on top of the bearing.

34550 Handy Packer Bearing Packer. Clam Shell. Shipping wt. 1 lb. 4 oz.



U.S. Pat No. 6,520,292

65250 UNIVERSAL BEARING PACKER

Fast, Efficient, Thorough.

Simply place the bearing between the plastic cones, tighten, and apply grease through the fitting on the end of the threaded shaft. Forces out old grease and evenly injects fresh grease. Cone diameter is 4-1/2".

65250 Universal Bearing Packer. Skin-packed. Shipping wt. 7 oz.

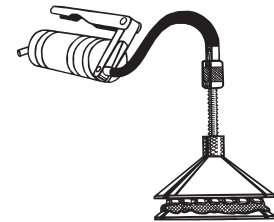

U.S. Pat No. 6,247,554

56750 SEAL PULLER

For Oil and Grease Seals.

Simply insert the tip of the tool behind the oil or grease seal, press and pull. Leverage works for you. Two size tips reach in and fit nearly all seal applications.

56750 Seal Puller. Skin-packed. Shipping wt. 15 oz.

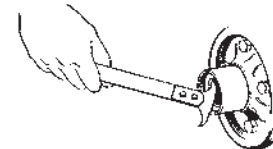

56650 ADJUSTABLE SEAL PULLER

Head Adjusts to 5 Positions.

Two hook sizes easily remove most oil and grease seals. Where clearance is a problem, remove the pin to reposition the head. The adjustable head works great on front wheel drive transaxles. Also works on front crankshaft seals without removing the radiator.

56650 Adjustable Seal Puller. Skin-packed. Shipping wt. 15 oz.



U.S. Pat No. 7,039,993

56920 LIMITED ACCESS SEAL PULLER

Use With 3/8" Drive for Hard-to-reach Oil and Grease Seals.

Simply insert hook behind seal and pull. Two hook sizes to fit most oil and grease seals. Can also be used with a breaker bar for extra reach or leverage. If the puller tips wear, resharpen on a grinding wheel.

56920 Limited Access Seal Puller. Skin-packed. Shipping wt. 3 oz.

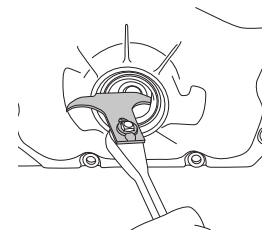

39500 39550 39700 39750 FWD AXLE NUT SOCKETS 6 PT.

For All 30mm, 32mm, 34mm and 36mm Axle Nuts.

Durable, impact-grade material. Deep to fit over variable axle lengths. Works where standard sockets won't. Use 1/2" drive.

39500 FWD Axle Nut Socket (30mm). Hang Tag. Shipping wt. 1 lb. 3 oz.

39550 FWD Axle Nut Socket (36mm). Hang Tag. Shipping wt. 1 lb. 13 oz.

39700 FWD Axle Nut Socket (32mm). Hang Tag. Shipping wt. 1 lb. 6 oz.

39750 FWD Axle Nut Socket (34mm). Hang Tag. Shipping wt. 1 lb. 10 oz.

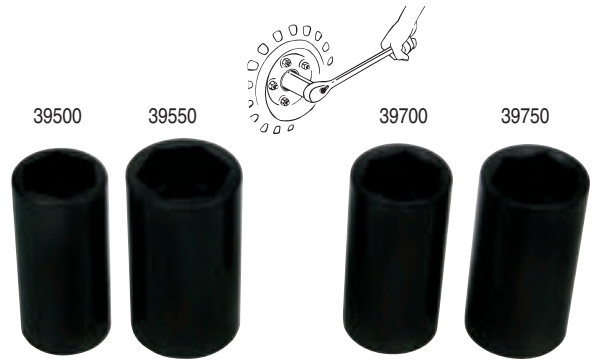

39650 39MM 12 PT. AXLE NUT SOCKET FOR TOYOTA

Removes and Installs Axle Nuts on 4-Wheel Drive Axle Hubs.

Made of durable, impact-grade heat-treated alloy steel. Extra deep design fits over various axle lengths. Works where standard sockets won't. Use with 1/2" drive.

39650 39mm 12pt Axle Nut Socket for Toyota. Hang Tag. Shipping wt. 1 lb. 4 oz.



Applications: Toyota Land Cruiser 2008-2010, Toyota Sequoia 2008-2010, Toyota Tundra 2007-2010, Lexus LX 570 2008.



39510 30MM 12 PT. AXLE NUT SOCKET

Removes and Installs Axle Nuts and Automatic Transmission Tail Output Shafts.

Heat-treated alloy steel, impact quality, extra deep, 1/2" drive.

39510 30mm 12pt Axle Nut Socket. Hang Tag. Shipping wt. 1 lb. 4 oz.

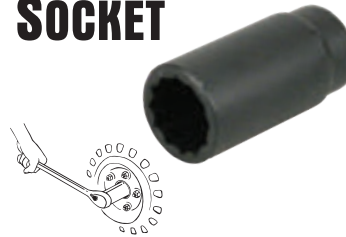

Applications: Chrysler- 300C, Crossfire 2004, Dodge- Freightliner Sprinter vans with 215mm rear axle 2004 and up, Magnum 2004, Jeep- Grand Cherokee V6 models 2005, Lexus- ES300, Pontiac- Vibe, Mercedes- many models, Toyota- Avalon, Camry, Highlander, Matrix, VW- Beetle, Jetta, Golf 1999 and up.

22090 36MM 12 PT. AXLE NUT SOCKET

Durable Impact-Grade Material Sockets for Removing and Installing Axle Nuts.

Fits some European vehicle applications and uses 3/4" drive.

22090 36mm 12 pt. Axle Nut Socket. Mini Pouch. Shipping wt. 15 oz.



31550 AXLE HUB BRIDGE NUT SOCKET FOR GM

Removes and Installs the Hub Bearing Retaining Nut Found on Some GM GMT900 Platform Full-Size Trucks.

The socket has nine drive pins to fit the new style retaining nut found on 2-wheel and 4-wheel drive Cheyenne, Silverado, Escalade, Sierra and Avalanche trucks with 10.5" or 11.5" ring gear. Made from alloy steel. Use with 1/2" drive.

31550 Axle Bridge Nut Socket GM. Box with color label. Shipping wt. 2 lbs. 8 oz.



30800 CV BOOT CLAMP PLIERS

For Ear-Type Clamps.

For all ear-type clamps including GM FWD outboard CV joints. Designed for use with a torque wrench, as required for stainless steel bands.

30800 CV Boot Clamp Pliers (Ear-Type). Skin-packed. Shipping wt. 1 lb. 3 oz.



30600 OFFSET BOOT CLAMP PLIERS

Crimps Ear-Type Clamps in Hard-to-Reach Areas.

A special boot clamp crimping pliers that is designed to work in confined spaces. The pliers work from the side (head is turned 90 degrees) unlike traditional tools that work from the end. The unique offset design allows the technician to work on clamps on larger size boots. The top plate on the pliers flattens the crimp. These pliers work on most ear-type clamps except those requiring a torque reading.

30600 Offset Boot Clamp Pliers. Skin-packed. Shipping wt. 12 oz.



30500 CV BOOT CLAMP PLIERS

For Earless-Type Clamps.

A sturdy, low-cost tool. Works on earless-type clamps including those found on GM inboard CV joints.

30500 CV Boot Clamp Pliers (Earless-Type). Skin-packed. Shipping wt. 13 oz.



30950 CV JOINT BANDING TOOL

For All Band-It® and Band-It Jr.® Style Clamps.

Works on all CV joints using the Band-It or Band-It Jr. type boot bands. Use 5/8" socket or wrench to wind and crimp new band on boot. Tool is easily disengaged from the band after the band is tightened.

30950 CV Joint Banding Tool. Skin-packed. Shipping wt. 7 oz.

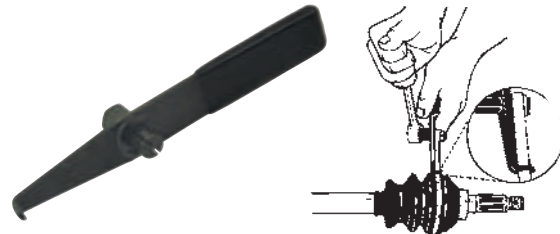

Band-It and Band-It Jr. are trademarks of Band-It-IDEX, Inc.

27250 27400 29900 4-WD WHEEL BEARING LOCK-NUT TOOLS

27250 for 4-slot applications. 27400 combination tool for both 4-slot and 6-slot applications. 29900 Fits 4-slot 2-1/2" lock rings used on common 4-WD trucks. 1/2" drive. Not for use with impact wrench.

27250 Wheel Bearing Lock-Nut Tool. Hang Tag. Shipping wt. 1 lb. 8 oz.

27400 Combination 4-WD Wheel Bearing Lock-Nut Tool. Hang Tag. Shipping wt. 1 lb. 7 oz.

29900 4-WD Bearing Lock-Nut Tool. Hang Tag. Shipping wt. 1 lb. 6 oz.

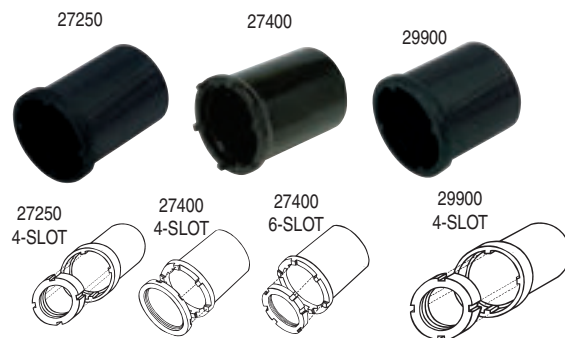

28000 RATCHETING LOCK NUT TOOL

Double-Ended for Both Sizes of Ratcheting Style Lock Nuts.

Two tools in one! Small end fits Ford 1986 to 1994 light trucks with Dana 44 front axle. Large end fits 1985 & newer Ford F150 - F350 trucks with the Dana 80 full floating rear axle. Press tool into lock nut and rotate to release the ratchet inside the lock nut. A torque wrench is used when installing. Use with 1/2" square drive.

28000 Ratcheting Lock Nut Tool. Clam Shell Package. Shipping wt. 2 lbs. 10 oz.

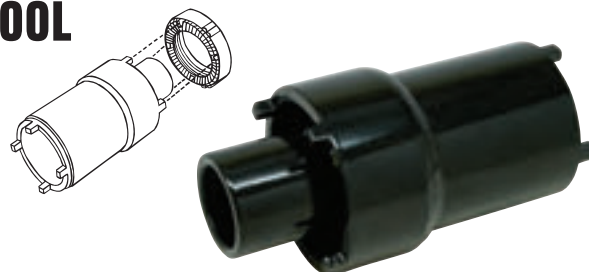

17350 PIPE STRETCHER KIT 34400 PIPE STRETCHER

Stretches All Pipe Including Stainless Steel.

Use with an impact wrench to quickly stretch pipes. Collet sets expand pipes from 1-5/8" to 4-1/4". The tool can be used on the vehicle. The pipe stretcher is a convenient, inexpensive alternative to hydraulic pipe expanders. The kit comes in a molded case for storage.

17350 Pipe Stretcher Kit. Molded Case. Shipping wt. 9 lb. 14 oz.

17510 Extender #1	17520 Extender #2
17530 Extender #3	17540 Extender #4
17550 Extender #5 (must be used with 17530)	17710 O Ring #1
17720 O Ring #2	17730 O Ring #3
17740 O Ring #4	17750 O Ring #5
34400 Pipe Stretcher. Clam Shell Package. Shipping wt. 4 lb. 10 oz	
34490 Large O Ring	34500 Small O Ring



34400 PIPE STRETCHER
(AVAILABLE INDIVIDUALLY IN A CLAM SHELL PACKAGE.)



32500 32750 TAILPIPE EXPANDERS

Removes clamp grooves and rounds out pipes.

Practical, rugged tools that make easy work of a tough job. Two sizes fit most pipes: 32500 - 1-5/8" to 2-7/16" (41.3mm - 61.9mm) and the 32750 - 2-3/8" to 3-1/4" (60.3mm - 82.5mm).

32500 Tailpipe Expander. Clam Shell Package. Shipping wt. 2 lbs. 13 oz.

32750 Tailpipe Expander. Boxed. Shipping wt. 4 lbs. 2 oz.



	For 32500	For 32750
Threaded Cone	32610	32780
Plain Cone	32620	32770
Cone Spacer	32630	32790
"O" Ring Kit	32030	32740



USE WITH
WRENCH OR
IMPACT TOOL

38350 EXHAUST REMOVAL PLIERS

Separates Exhaust Hanger Brackets From Rubber Supports.

The exhaust pliers work on all import and domestic car and truck exhaust systems that use the rubber hanger supports. Simply squeeze the handles to push the bracket from the rubber support.

38350 Exhaust Removal Pliers. Skin-packed. Shipping weight 1 lb. 3 oz.



U.S. Pat No. D495,225

31500 EXHAUST/STRUT CUTOFF TOOL

Cuts Out-of-Round Pipes.

Four knife-edged cutting wheels cut quickly and cleanly. Can be operated with one hand. Less than 1/3 turn cuts all the way around the pipe. Unique design allows tool to "shift" to make out-of-round cut. Big 1-3/8" to 2-1/2" (34.9 - 63.5mm) range.

31500 Exhaust / Strut Cutoff Tool. Skin-packed. Shipping wt. 1 lb. 7 oz.

31530 Set of Four Replacement Cutter Wheels for 31500

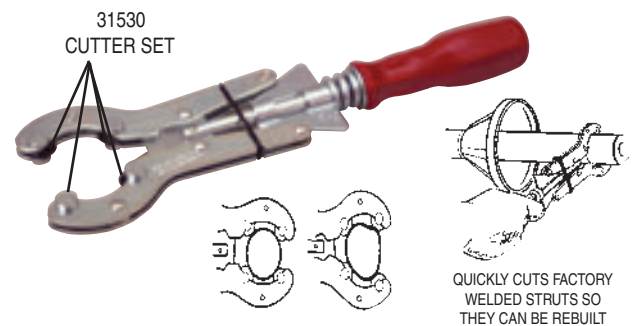

QUICKLY CUTS FACTORY WELDED STRUTS SO THEY CAN BE REBUILT

32000 PIPE END SHAPER

Rounds Pipes In or Out.

Rounds out exhaust pipes that are crushed or bent. Also reshapes pipes bent or flared out by placing big end over pipe. Range is 1-1/2" - 3-5/8" (38.1 - 92mm).

32000 Pipe End Shaper. Boxed. Shipping wt. 4 lbs. 15 oz.

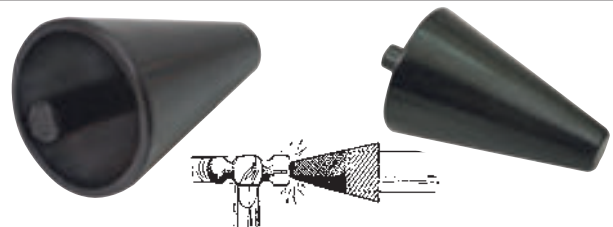

18500 19500 20500 21000 21500 RING COMPRESSORS

Lisle Spring Clutch Eliminates Ratchet Problems.

The Lisle spring clutch assures a proper fit on the piston and a positive locking action.

18500 Small Engine Ring Compressor. Range 1-1/2" to 3" (38.1-76.2mm)

Boxed. Shipping wt. 5 oz. NSN 5120-00-322-6223

19500 Ring Compressor. Range 2-1/8" to 5". (Height 3-1/2") Skin-packed.

Shipping wt. 12 oz. NSN 5120-00-250-6055

20500 Ring Compressor. Range 3-1/2" to 7". (Height 3-1/2") Skin-packed.

Shipping wt. 14 oz. NSN 5120-00-223-8848

21000 Ring Compressor. Range 3-1/2" to 7". (Height 7") Boxed.

Shipping wt. 1 lb. 11 oz. NSN 5120-00-116-7676

21500 Ring Compressor. Range 7" to 10". (Height 7") Boxed. Ship. wt. 2 lbs. 4 oz.



19000 TAKE-APART RING COMPRESSOR

Combines Lisle Spring Clutch with Take-Apart Feature

Necessary for Volkswagens, motorcycles, outboard motors, etc. Quick release makes it easy to remove from connecting rod.

Can be used on conventional engines with narrow ring spacing.

19000 Ring Compressor. Range 2-1/8" to 5". (54-127mm) Boxed. Shipping wt. 6 oz.



21700 WRINKLE BAND RING COMPRESSOR

4 Ways Better!

1. LOW FRICTION! Wrinkle Band cuts friction in half. Rings slide in easily.
2. WRINKLE BAND! Can't slip down into cylinder.
3. CAM OPERATED! Set adjustment screw just once for entire set of pistons.
4. FASTER! Insert a full set of pistons in half the time, with half the work!

21700 Wrinkle Band Ring Compressor. Skin-packed. Shipping wt. 6 oz.

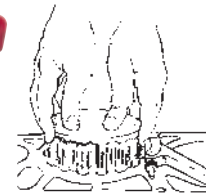

RINGS SLIDE IN EASILY
RANGE 3" TO 5"
(76.2-127mm)

33500 PISTON RING INSTALLER

Save by Reducing Ring Breakage.

Tapered jaws to remove and install most passenger car and light truck rings from 3/64" to 1/4" (1.2 - 6.3mm).

33500 Piston Ring Installer. Skin-packed. Shipping wt. 4 oz.

NSN 5120-00-857-3190

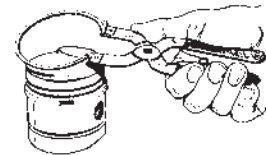

36500 RIDGE REAMER

Big Range Scraper Action.

Rollers assure easy turning in cylinder. Exclusive stabilizer spring allows operator to take selective cut to minimize chatter.

Spring-loaded carbide cutter follows contour of cylinder.

Complete ridge removed in just a few easy turns. Offset jaw guides assure rigidity throughout the range.

36500 Ridge Reamer. Range 2-11/16" - 5-5/16" (68.3 - 134.9mm) Clam Shell

Package. Shipping wt. 2 lbs. 3 oz. NSN 5110-00-228-7009

36510 Carbide Cutter

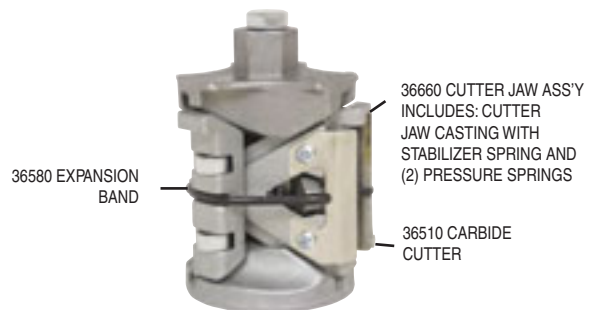

16750 VALVE SPRING COMPRESSOR

An "ON THE CAR" Tool.

Makes compressing the spring and removing the keepers a simple job. No need to remove the head. Adjustable cam action. No need to readjust the tool after each spring.

16750 Valve Spring Compressor. Clam Shell Package. Shipping wt. 1 lb. 15 oz.

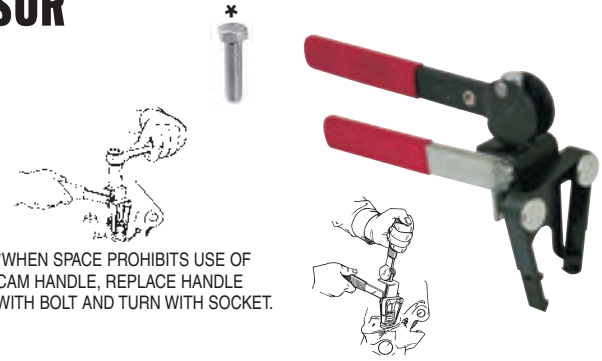

*WHEN SPACE PROHIBITS USE OF CAM HANDLE, REPLACE HANDLE WITH BOLT AND TURN WITH SOCKET.

16550 OVERHEAD VALVE SPRING COMPRESSOR

Compresses Valve Springs for Keeper Removal without Removing Cylinder Heads.

Offset jaws grip springs securely and compress the springs evenly.

16550 Overhead Valve Spring Compressor. Skin packed. Shipping wt. 15 oz.

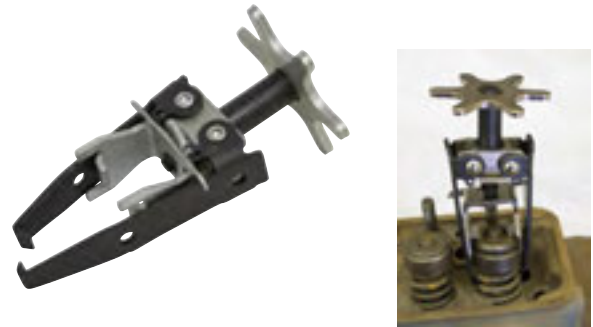

23300 SMALL ENGINE VALVE SPRING COMPRESSOR

For Springs 3/4" to 1-1/16".

Heavy-duty frame and screw for rigidity. Two jaw sizes. For Briggs and Stratton, Clinton, Harley-Davidson, etc.

23300 Small Engine Valve Spring Compressor. Skin-packed. Shipping wt. 1 lb.



44300 VALVE SPRING COMPRESSOR

High Leverage Allows One-Hand Operation.

Exceptionally strong, rigid frame, weighs only 6 lbs. Works with nearly all valve-in head and L-head engines as well as truck and tractor engines.

44300 Valve Spring Compressor. Boxed. Shipping wt. 8 lbs. 4 oz.

44770 Set of Offset Jaws. 7/8" to 2-1/4" (22.2 - 57.1mm) capacity.

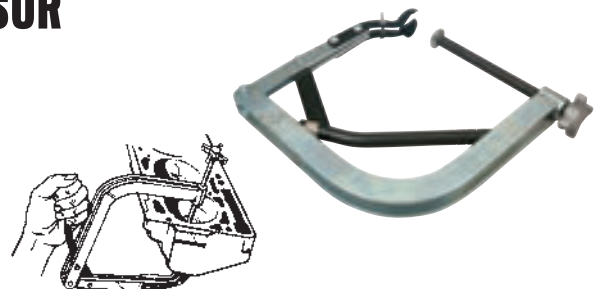

24000 RING GROOVE CLEANER

Comes with Two Easy-To-Set Cutter Wheels.

Heavy coil spring holds cutter in groove for fast removal of carbon. Tool comes with standard 24020 cutter blade sizes: 5/64", 3/32", 1/8", 5/32", 3/16" and special 24350 cutter blade with sizes: 1.5mm, 1/16", 1.75mm, 2mm, and 1/4". Handles pistons 2-3/4" to 5" diameter.

24000 Ring Groove Cleaner. Skin-packed. Shipping wt. 11 oz.

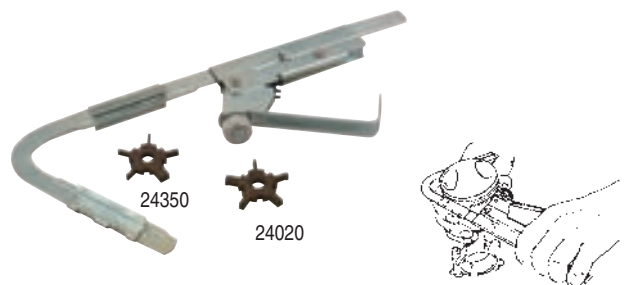

36050 VALVE KEEPER REMOVER & INSTALLER KIT

Quickly Removes and Installs Valve Keepers On Most Overhead Valve Engines With Valve Stems From 4.5 to 7.5mm and 5/16" to 3/8".

Makes valve component disassembly and reassembly fast and easy. Push or tap tool with a hammer to remove valve keepers. Magnet in tool body captures keepers for quick removal and valve disassembly. To install keepers, load in retainer on valve stem, then push or tap handle to install. Can be used on the car or bench. New smaller size works on Toyota four cylinder and Chrysler New World Engine applications.

36050 Valve Keeper Remover & Installer Kit. Molded case. Shipping wt. 2 lbs. 4 oz.

36330 Mercedes Adapter	36340 Installer
36380 Handle Assembly	36440 Metric Installer
36740 Metric Handle Assembly	



36200 VALVE KEEPER REMOVER & INSTALLER

36200 Valve Keeper Remover & Installer. Skin-packed. Shipping wt. 2 lbs. 12 oz.

36330 Mercedes Adapter	36340 Installer
36380 Handle Assembly	



34350 WATER SENSOR WRENCH FOR DURAMAX

Removes & Installs the Water Sensor on 2001 - 2011 6.6L Duramax Diesel Engines.

Use when replacing the fuel filter or when servicing the water sensor. Plastic sensor has a 12 sided design that is easily damaged by tools, like pliers, that do not specifically fit the sensor.

34350 Water Sensor Wrench for Duramax. Skin-packed. Shipping wt. 7 oz.

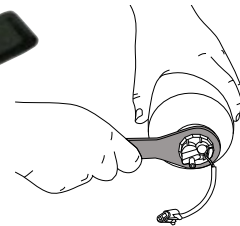

34900 WATER SENSOR WRENCH, LATE MODEL

Removes and Installs the Water Sensor Located on the Fuel Filter on 2012 and Newer 6.6L Duramax Diesel Engines.

Also works on 2013 and newer 6.7L Cummins. For use when replacing the fuel filter or when servicing the water sensor. The plastic sensor has a new hex design that is easily damaged by tools, like pliers, that do not specifically fit the sensor. Use the 34350 or 34910 for older applications.

34900 Water Sensor Wrench, Late Model. Skin packed. Shipping wt. 6 oz.



34910 WATER SENSOR WRENCH, AFTERMARKET

Removes and Installs the Aftermarket Water Sensor Located on the Fuel Filter on 2001 through 2011 6.6L Duramax Diesel Engines.

For use when replacing the fuel filter or when servicing the water sensor. The aftermarket plastic sensor has a modified octagon shape that is easily damaged by tools, like pliers, that do not specifically fit the sensor. Use 34350 for standard or OE applications.

34910 Water Sensor Wrench, Aftermarket. Skin packed. Shipping wt. 6 oz.



23500 STONE-TYPE GLAZE BREAKER

Full 2" to 7" Range (50.8 - 177.8mm).

Controlled pressure assures positive, adjustable contact through full range. Operates with any electric drill. Furnished with 3" long 220 grit stones, see below for other grits. Adjustable stop collar permits quick selection of two range settings, from 2" to 4" and from 4" to 7". Stone arms are easily compressed to eliminate cylinder scratches.

23500 Glaze Breaker, Range 2" to 7". Skin-packed. Shipping wt. 1 lb. 5 oz.

23520 Set Replacement Stones, 220 grit. Skin-packed. Shipping wt. 3 oz.

23530 Set Special Hard Stones, 240 grit. For use after re-boring only. Not for glaze breaking. Skin-packed. Shipping wt. 3 oz.

23540 Set Replacement Stones, 320 grit. Suitable for use when installing moly rings. Skin-packed. Shipping wt. 3 oz.

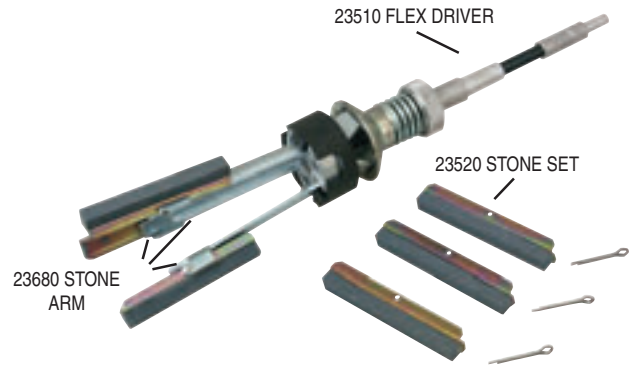

15000 ENGINE CYLINDER HONE

Best by Far - Yet Competitively Priced.

Micrometer head assures accuracy in feeding. Expands quickly to cylinder size with fast action rack and pinion. Bottom guard plate helps prevent stones from accidentally hitting the crankshaft. Universal joint action makes grinding of back cylinder easy. Clip-on stones and wipers are easily changed in a few seconds. Stones are available in five grits. Stone for Nikasil cylinders available. See chart. Use with heavy-duty 1/2" drill. Standard range 3" to 4-1/4". Big range (2 3/4" - 10-1/4") with additional rack sets and stone sets. Long 5" stones cut faster, more accurately.

15000 Engine Cylinder Hone Set. NSN 4910-00-554-9245. Shipping wt. 6 lbs. 2 oz. Includes the following: Cylinder hone body with 1 set of 15540 standard range rack (range is 3" to 4-1/4"). 1 set each of 15500 coarse stones and 15510 medium stones, cleaning brush and dressing paddle in a sturdy storage case.

See chart for rack sets and stone and wiper sets available. All stone and wiper sets consist of two stones and two wipers. Order by part number. All are 5 inches long, and weigh 7 oz.

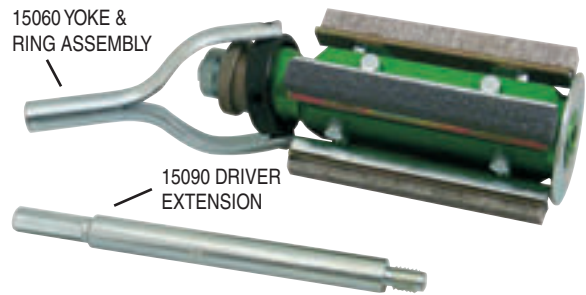

Cylinder Size Range	Rack Set Part No. Weight	Stone and Wiper Set Part Numbers				Special Hard Bond for Steel 150 Grit
		80 Grit	180 Grit	280 Grit	500 Grit	
2 3/4" - 3 3/4" 69.8 - 95mm	15550 1 lb.	15680 *15740	15690	15700	----	----
3" - 4 1/4" 76.2 - 108mm	15540 1 lb. 2 oz.	15540	15510	15520	15990	15490
4" - 6 1/4" 100 - 158mm	15530 1 lb. 6 oz.	15500	15510	15520	15990	15490
6 1/8" - 10 1/4" 155 - 260mm	15560 1 lb. 14 oz.	15500	15510	15520	15990	15490

* For Nikasil Cylinders

16000 SMALL CYLINDER HONE

For 1-3/4" to 2-3/4" (44.5 - 69.9mm) Cylinders.

Precision built for small cylinders. Stones are 3-1/2" long, assuring unusual accuracy. Stones cover full range, are easily changed, and available in four grits. Comes complete with 16410, 16420 and 16430 medium grit stone sets in sturdy storage case. Stones for Nikasil cylinders available. See chart.

16000 Small Cylinder Hone. Range 1-3/4" to 2-3/4". Shipping wt. 4 lbs. 10 oz.

See chart for rack sets and stone and wiper sets available. All stone and wiper sets consist of two stones and two wipers. Order by part number. All are 3-1/2 inches long, and weigh 3 oz.

Cylinder Size Range	Stone and Wiper Set Part Numbers			
	80 Grit	180 Grit	280 Grit	For Alum.
1.75" - 2.20" 44.5 - 55.9mm	16440	16410	16380	16470
2.05" - 2.50" 52 - 63.5mm	16450	16420 *16580	16390	16480
2.35" - 2.75" 59.6 - 69.9mm	16460	16430 *16590	16400	

* For Nikasil Cylinders

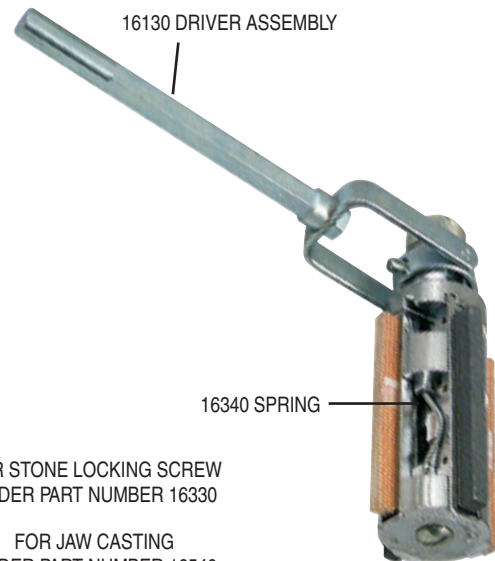

FOR STONE LOCKING SCREW
ORDER PART NUMBER 16330

FOR JAW CASTING
ORDER PART NUMBER 16540

65600 BROKEN SPARK PLUG REMOVER FOR FORD TRITON 3 VALVE ENGINES

Set Includes a Unique Porcelain Pusher Tool.

This tool set removes broken spark plugs from 2004 to 2008 Triton 3 valve per cylinder engines, (a common problem). The set includes a unique porcelain pusher tool and a tapered left-hand thread remover for removing the broken spark plug without leaving the porcelain in the engine cylinder. Porcelain pusher is used to press the porcelain piece, without breaking the porcelain, farther into the plug tip. This provides space for the left hand thread remover to bite into the stainless steel plug tip so it can then be pulled.

65600 Broken Spark Plug Remover for Ford. Molded Case. Shipping wt. 1 lb. 13 oz.

58980 Gasket (x4)	65610 Puller Housing
65620 Puller Screw	65660 Left Hand Hex Nut
65670 Porcelain Pusher Assembly	



PUSHING PORCELAIN



PULLING BROKEN PLUG



U.S. Pat No. 7,814,814

65700 BROKEN SPARK PLUG REMOVER KIT FOR FORD TRITON 3 VALVE ENGINES

The Popular Broken Plug Tip Remover Plus a Special Porcelain Puller Tool.

A kit for removing spark plugs that have seized in the engine head. Includes a Porcelain Puller Tool that locks onto the terminal of a broken spark plug to pull the porcelain if only the metal collar of the plug came loose. Also includes a Porcelain Pusher for when the porcelain breaks off in the spark plug tip and a Self-Tapping Puller to remove the seized metal tip. Comes in a blow molded plastic case for storage. Order Lisle 65710 for the Porcelain Puller individually, or 65730 for the Porcelain Puller, Right Hand Hex Nut and Puller Housing.

65700 Broken Plug Rmvr Kit Ford. Molded Case. Shipping wt. 2 lbs. 3 oz.

58980 Gasket (x4)	65610 Puller Housing
65620 Puller Screw	65660 Left Hand Hex Nut
65670 Porcelain Pusher Assembly	65710 Porcelain Puller
65720 Right Hand Hex Nut	65730 Porcelain Plr w/Housing



U.S. Pat No. 7,814,814

65000 DEEP HOLE ALUMINUM HEAD M14X1.25 SPARK PLUG HOLE REPAIR KIT

Replaces Stripped Spark Plug Threads in Aluminum Heads with 14mm Spark Plugs.

Installs a new solid steel spark plug thread insert in original thread location. Set includes one-piece drill tap, long tap holder, short tap holder, insert installer, swedger and handle. Includes three insert sizes: 5/16", 7/16" and 11/16".

65000 Deep Hole Al Head M14x1.25 Spark Plug Hole Repair Kit. Molded Case.

Shipping wt. 3 lbs. 2 oz.

65010 Drill Tap	65020 Long Tap Holder
65030 11/16" Insert (5 pack)	65040 Swedger
65060 7/16" Insert (5 pack)	65070 Short Tap Holder
65080 5/16" Insert (5 pack)	65090 Insert Installer
65100 Swedger Handle	66160 Set Screw



22100 FLYWHEEL LOCKING TOOL FOR 6.6L DURAMAX

Locks Flywheel in Place When Removing Harmonic Balancer on 6.6L Duramax Engines with Allison Automatic Transmissions.

Saves time by locking the flywheel at the transmission instead of having to remove the starter for water pump replacement. On 2500 and 3500 pickups, remove metal spring-loaded inspection plate on the bottom of the transmission. Tool should slide into opening toward engine with the top of the tool engaging the teeth of the flywheel. On 4500 and 5500 trucks, remove the rubber inspection cap on the bottom of the transmission. Insert the tool at the front of the opening to engage the flywheel and hand tighten bolt to hold tool in place. Use 36mm 12-point socket with 3/4" square drive to remove harmonic balancer bolt and retorque on installation.

22100 Flywheel Locking Tool for 6.6L Duramax. Clam Shell Package. Shipping wt. 2 lbs.

22090 36mm 12 pt. Socket

22110 Duramax P/U Flywheel Lock

22120 Duramax 4500/5500 Flywheel Lock

22170 Socket Head Cap Screw

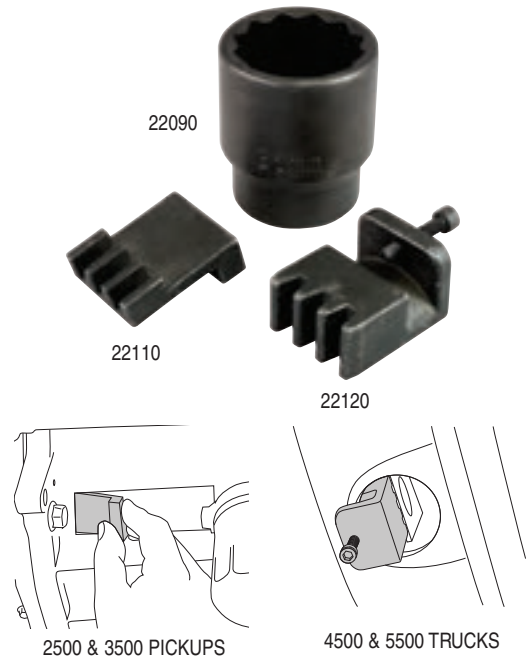

23800 FLYWHEEL TURNER

Hold or Turn Flywheels and Flexplates on Most Vehicles.

Use this special wrench to turn the flywheel and rotate the engine. Also holds the flywheel or flexplate when torquing the flywheel or harmonic balancer bolts. Folds for easy storage.

23800 Flywheel Turner. Skin-packed. Shipping wt. 1 lb. 4 oz.

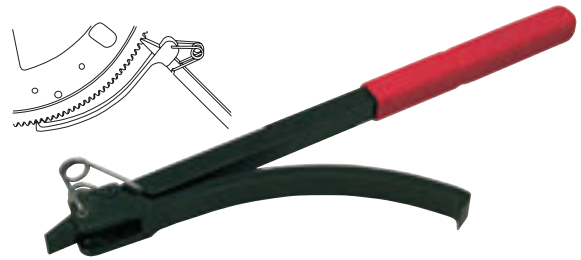

21100 21200 VALVE LAPPERS

For Hand Lapping Valves.

Thick handles for easy lapping. 21100 has 1-1/8" and 1-3/8" diameter cups for larger valves. 21200 has 5/8" and 13/16" diameter cups for smaller valves.

21100 Large Valve Lapper. Skin-packed. Shipping wt. 4 oz.

21200 Small Valve Lapper. Skin-packed. Shipping wt. 2 oz.



19700 VALVE HOLDER

For Both 14mm & 18mm Spark Plug Threads.

Commonly used when valve springs or valve stem seals are replaced. Air pressure helps prevent the valve from falling into the combustion chamber. Comes with two-step fitting for both 14mm & 18mm threads. Heavy duty 12" flexible hose allows easy access to spark plug hole and air supply. Thread fitting to spark plug hole and other end to air supply.

19700 Valve Holder. Skin-packed. Shipping wt. 5 oz.

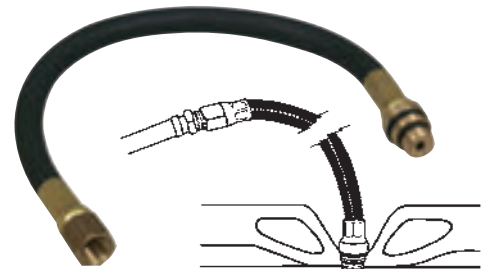

62200 HEATER HOSE COUPLER REMOVER

Removes Broken Heater Hose Couplers.

Drive the tool into the broken coupler. The splines cut their way into the coupler, allowing you to turn it out with a 5/8" socket or wrench.

62200 Heater Hose Coupler Remover. Skin-packed. Shipping wt. 2 oz.



U.S. Pat No. 6,575,057

22500 THERMOSTAT GASKET CLEANER

Cleans All Hard To Reach Gasket Surfaces.

Use with a die grinder to quickly clean gasket surfaces on Dodge pickups, oil pans, water pumps and other inaccessible applications. The tool is equipped with a floating guide shaft so the user can steer the abrasive pad around the gasket surface. Includes interchangeable short shaft.

22500 Thermostat Gasket Cleaner. Skin-packed. Shipping weight 4 oz.

22570 Abrasive Pad

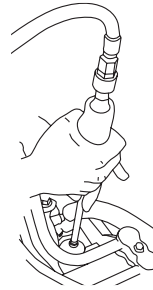

U.S. Pat No. 7,001,255

13800 WATER PUMP SPROCKET HOLDER FOR GM ECOTEC

Holds the Timing Chain and Gear in Place While Removing or Installing Water Pump on Ecotec Engines.

Securely holds water pump sprocket preventing loss of timing or damage to the engine. Special half-moon design allows easier access to water pump gear bolts. Uses access cover bolts to hold the tool in place.

13800 Water Pump Sprocket Holder for GM Ecotec. Skin-packed. Shipping wt. 4 oz.

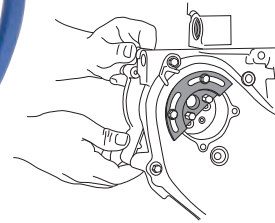

14440 WATER PUMP WRENCH FOR GM NORTHSTAR

Removes & Installs the Water Pump Assembly on GM Northstar 4.0L & 4.6L Engines.

Turn the tool with a 1/2" drive ratchet or breaker bar. Angled teeth prevent the tool from slipping.

14440 Water Pump Wrench for GM Northstar. Hang Tag. Shipping wt. 15 oz.

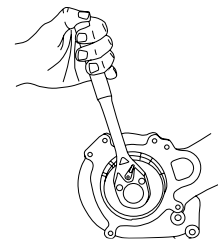

13500 41MM WATER PUMP WRENCH FOR GM 1.6L

Use With 3/8" Square Drive and Short Extension to Easily Adjust and Hold the Water Pump When Replacing or Adjusting Timing Belt.

Stubby tool design allows access to timing belt sprocket without interference from vehicle frame. Works on 1.6L engines in 2004-current Chevrolet Aveo excluding 2009 with variable timing engine and 1999-2002 Daewoo Lanos. Heat-treated alloy steel for strength.

13500 41MM Water Pump Wrench for GM 1.6L. Mini-pouched. Shipping wt. 6 oz.



18980 PNEUMATIC U-JOINT DRIVER

Quickly Removes the U-Joint Cap from the Drive Shaft on Most Rear Wheel Drive Vehicles.

Use the driver with an air hammer to remove u-joint caps up to 1-5/16" diameter. Prevents damage to drive shaft and axle shaft ears, when presses or chisels are used. On some vehicles the u-joint is retained with plastic from the factory. The plastic must be removed prior to driving out the u-joint caps.

18980 Pneumatic U-Joint Driver. Skin-packed. Shipping wt. 1 lb. 4 oz.

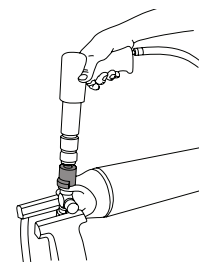

U.S. Pat No. 7,356,899

18000 UNIVERSAL CAMSHAFT BEARING TOOL

Drives Camshaft Bearings Smoothly.

Now, one complete low cost set that will remove or insert camshaft bearings in nearly all engines from compact cars to heavy trucks. Range of 1.125" to 2.69" (28.58 - 68.3mm). **EASY ON BEARINGS.** The expander has a neoprene sleeve over which the split driving collets are mounted and expanded to size. This tool has two sets of rubber sleeves supplied with it for each expanding collet. The brown sleeves are used when driving thin wall bearings (.065). The black sleeves should be used when driving thick wall bearings (.090). Instruction sheet T18000 provides complete, illustrated operating instructions and parts list.

18000 Universal Camshaft Bearing Tool. Molded Case. Shipping wt. 11 lbs. 4 oz.

Range 1.125" to 2.690". Includes: Driving shaft, driving shaft extension, expander unit, five (5) expanding collets, five (5) sleeve sets, two (2) driving collars, centering cone & blow molded case.

Shipping wt. 17 lb. NSN 5120-00-878-8541

DRIVER RANGE TABLE

BEARING SIZE I.D.	EXPANDING COLLET #	USE WASHER	SLEEVE SET #
1.125 TO 1.475	Expander ass'y 18330	18430	18410
1.475 TO 1.700	18020	18430	18120
1.700 TO 1.925	18040	18420	18140
1.925 TO 2.150	18060	18420	18160
2.150 TO 2.375	18080	18420	18180
2.375 TO 2.690	18100	18420	18200

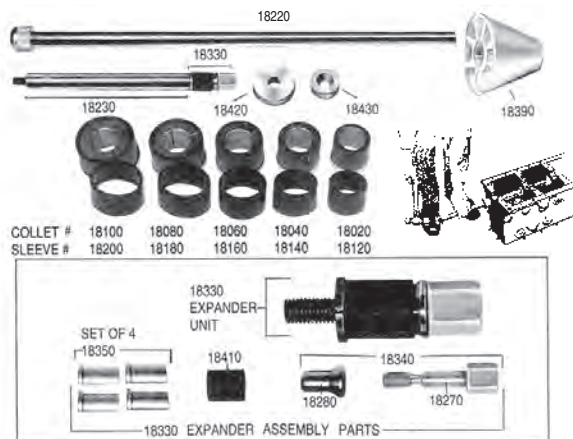

58430 SHAFT IN SEAL PULLER

Removes Cam Shaft and Crank Shaft Seals Without Damage to the Shaft.

Engage the adjustable hook behind the seal. Brace the push rod against the engine head and push the handle to remove the seal. Removes the seal without damage to the shaft.

58430 Shaft In Seal Puller. Skin-packed. Shipping wt. 6 oz.

58500 Hook

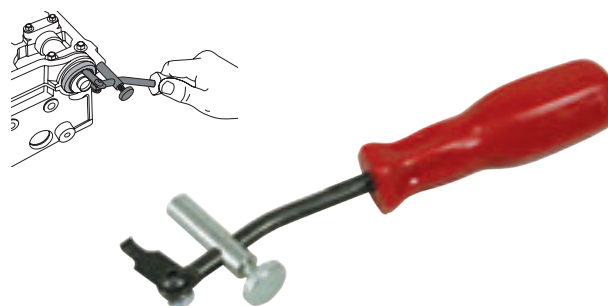

U.S. Pat No. 7,600,305

27000 SNEAKY PETE

Removes and Installs Upper Rear Main Seals Without Dropping Crankshaft.

The Lisle 27000 includes everything needed to speed up a long, slow job. Cork screw puller makes it easy to remove old seal. To install new seal, 27000 includes a pulling wire with a removable T-handle and spring steel clip that grips the seal firmly as it is pulled into position. Two extra clips are furnished. Saves many times its cost every time it is used.

27000 Sneaky Pete. Skin-packed. Shipping wt. 2 oz.

27020 Replacement Jaw Clip

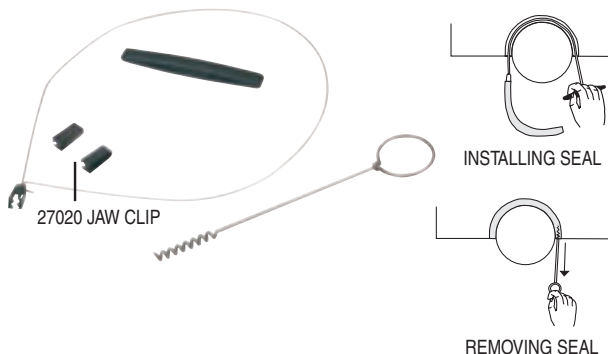

36880 DUAL OVERHEAD CAM (DOHC) LOCK TOOL

Locks Camshaft Sprockets in Place During Belt / Chain Replacement.

This versatile tool easily locks and holds both camshaft sprockets firmly in place. Unique design uses knurled pins to hold against the inside of the cam sprockets. The two parallel bars "float" which allows the knurled pins to align with the sprockets. Preserves the engine timing during belt or chain replacement.

36880 Dual Overhead Cam Lock Tool. Skin-packed. Shipping wt. 10 oz.

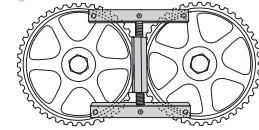

PINS HOLD AGAINST THE INSIDE OF THE CAM SPROCKETS

U.S. Pat No. 6,912,768
6,694,587

37410 CAMSHAFT ALIGNMENT KIT

For Servicing the Timing Belt, Chains, Head Gaskets, or Other Valve Train Repairs on Ford, Mercury and Mazda Vehicles.

The kit comes with an aluminum camshaft bar, plus one short top dead center (TDC) timing pin and one long TDC timing pin. The camshaft bar and long TDC timing pin are used on 2.0L DOHC Zetec engines found in 1994-2003 Ford and Mercury vehicles. The camshaft bar and short TDC timing pin are used on 2004-2012 2.5L DOHC, 2.3L DOHC 4V and 2.0L DOHC engines that are found in Ford, Mercury and Mazda vehicles. The camshaft alignment bar can also be used by itself on 2.0L DOHC engines in 1993-1994 Ford Probe.

37410 Camshaft Alignment Kit. Skin packed. Shipping wt. 6 oz.

37420 Timing Bar 37430 Short Timing Pin 37440 Long Timing Pin



ENGINE

YouTube

38220 UNIVERSAL CAM ADJUSTER

Adjusts to Fit Different Sized Cam Sprockets.

This adjustable tool is designed to both hold and turn cam sprockets. The tool is needed to turn the cam sprockets to adjust the cam position. It can also be used to hold the cam sprocket in place when removing the cam bolt. It will work on all single and dual overhead cam sprockets with holes.

38220 Universal Cam Adjuster. Skin-packed. Shipping wt. 1 lb. 2 oz.

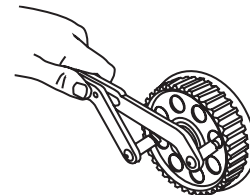

28500 STRAP WRENCH

Loosen or Tighten Cylindrical or Rectangular Objects.

Handy, self-tightening strap wrench won't slip. Works great for installing or removing timing belt sprockets or belt pulleys. Range from 1" to 6-5/8" round. Tensile strength of strap is 1350 P.S.I. Handle is made of glass-filled polypropylene which provides superior strength.

28500 Strap Wrench. Skin-packed. Shipping wt. 10 oz.

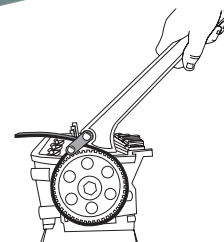

U.S. Pat No. 6,101,903

13200 OIL PRESSURE SWITCH SOCKET

Fits 1" and 1-1/16" Switches Up To 1-5/8" Long.

One socket with the correct length to fit 1" and 1-1/16" oil pressure switches (for vehicles equipped with warning lights). 1-7/8" overall height for clearance. Use with 3/8" drive or 1-1/8" hex.

13200 Oil Pressure Switch Socket. Hang Tag. Shipping wt. 5 oz.

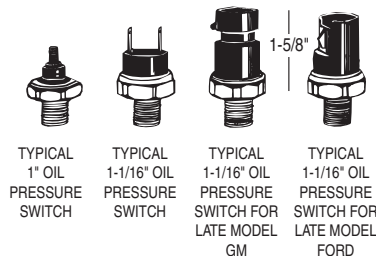

13250 OIL PRESSURE SWITCH SOCKET

Fits 1-1/16" Switches Up To 2-5/8" Long, Found on GM and Chrysler Vehicles.

Fits 1-1/16" oil pressure sending unit (gauge type), found on most all '91 and newer GM vehicles. Also fits '87 and newer Chrysler vehicles with combination light and gauge oil pressure switches. Use with 3/8" drive or 1-1/8" hex.

13250 Oil Pressure Switch Socket. Hang Tag. Shipping wt. 8 oz.

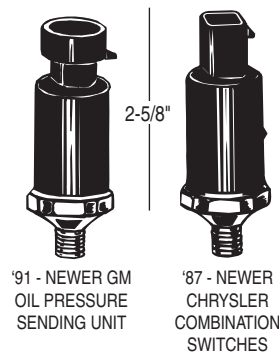

12100 OXYGEN SENSOR SOCKET

Removes and Installs Oxygen Sensors on Most Domestic and Some Imports.

Special 7/8" socket with cutaway slot to provide depth clearance for wire harness. Provides adequate depth to fit over sensor. Heat-treated alloy steel. Use with 3/8" square drive or 1" wrench.

12100 Oxygen Sensor Socket. Hang Tag. Shipping wt. 9 oz.

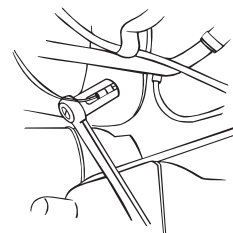

12390 DUAL DRIVE OXYGEN SENSOR WRENCH

Use with a Breaker Bar to Loosen Stubborn Oxygen Sensors. 1/2" and 3/8" drive.

Attach a 1/2" breaker bar on the end of the tool to initially loosen stuck sensors. Use a 3/8" ratchet on the top for fast removal and installation. Slotted body allows clearance for wire harnesses. Forged, heat-treated steel with six point design will withstand high torque removal applications.

12390 Dual Drive Oxygen Sensor Wrench. Skin-packed. Shipping wt. 10 oz.

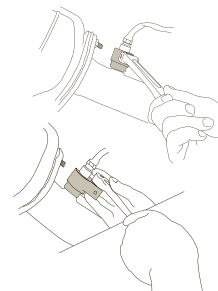

12230 OXYGEN SENSOR THREAD CHASER

Cleans Threads in Oxygen Sensor Holes.

Use with 3/4" hex socket or 3/8" square drive. Size: M18x1.5 Also works on M18x1.5 spark plug threads. IMPORTANT: Use anti-seize.

12230 Oxygen Sensor Thread Chaser. Skin-packed. Shipping wt. 3 oz.

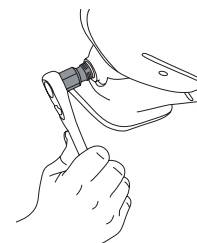

20250 COMPRESSION TESTER

Quickly and Accurately Check Compression on Gasoline Engines.

Gauge registers 0 - 300 P.S.I. and 0 - 2100 kpa. Fits 14mm and 18mm thread sizes.

20250 Compression Tester. Skin-packed. Shipping wt. 15 oz.

20100 Valve Core.

20280 14mm Adapter

20280
14mm ADAPTER



20530 10MM SPARK PLUG ADAPTER

20540 12MM SPARK PLUG ADAPTER

Spark Plug Thread Adapters for 20250 Compression Tester.

For testing on some automobile, motorcycle, ATV, chainsaw and marine gas engines. Includes o-ring.

20530 10mm Spark Plug Adapter. Mini-pouches. Shipping wt. 3 oz.

20540 12mm Spark Plug Adapter. Mini-pouches. Shipping wt. 3 oz.



20530



20540

75500 COMBUSTION LEAK DETECTOR

Quickly Pinpoints Combustion Leaks.

Detects bad head gaskets, cracked blocks, & cracked or warped heads. Fluid changes from blue to yellow when exposed to combustion gases from the radiator. Connect the hose to any vehicle vacuum line. Place tapered end of tool into radiator opening. With the engine running, the vehicle vacuum or the vacuum pump draws vapors through the indicating fluid for testing.

75500 Combustion Leak Detector. Clam Shell. Shipping wt. 1 lb. 14 oz.

75630 Replacement Fluid. 16 fluid oz.

75630



75700



LEAK DETECTED
(FLUID CHANGES
TO YELLOW COLOR)

U.S. Pat No. 6,806,092

75730 COMBUSTION LEAK DETECTOR FLUID FOR DIESEL

Detects Combustion Leaks on Diesel Engines.

Use the diesel leak detector fluid with the Lisle 75500 Combustion Leak Detector. Indicating fluid changes from red to yellow when exposed to diesel combustion gases in the radiator. Contains 16 fluid oz.

75730 Combustion Leak Detector Fluid for Diesel. Shipping wt. 1 lb. 4 oz.



NO LEAK PRESENT
(NO CHANGE IN
FLUID COLOR)



LEAK DETECTED
(FLUID CHANGES TO
YELLOW COLOR)

27800 UNIVERSAL NOID LIGHT

Adjustable Probes fit all Electronic Fuel Injection Systems.

Versatile tool tests throttle body injectors, ported fuel injectors and sequential central port injectors. One-person operation. Attach tool to the car body or windshield with suction cup. View the Noid Light from the front seat while cranking the ignition. A flashing light indicates normal pulses. No light or constant light indicates a problem. Two probe adapters screw on to form larger diameter probes.

27800 Universal Noid Light. Clam Shell. Shipping wt. 7 oz.

27790 Probe Adapter

27870 Bulb

27890 Wire Assembly

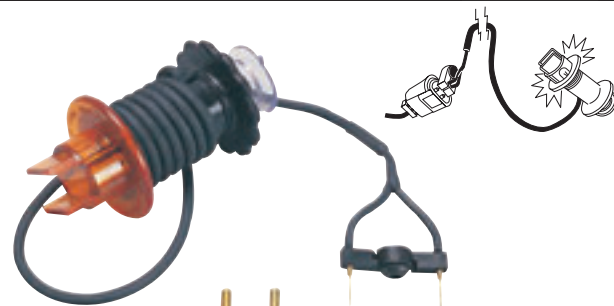

27790
(2) PROBE ADAPTERS

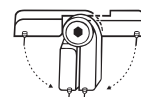

59370 STRETCH BELT REMOVER/INSTALLER

Combination Removal and Installation Tool for Most Stretch Belt Applications Found on Many Accessory Drive Systems.

Unique magnetic faces hold the tool in place on the pulley. Helps prevent damage to belt or pulley during removal or installation. Compact, one-piece tool can be used on the front or back side of the pulley.

59370 Stretch Belt Remover/Installer. Skin-packed. Shipping wt. 4.5 oz.



REMOVE



INSTALL



U.S. Pat No. 9,404,560

68500 MANIFOLD DRILL TEMPLATE FOR FORD 2V & 3V

Designed to Remove Broken Exhaust Manifold Studs on 4.6L, 5.4L 2 Valve, 5.4L 3 Valve and 6.8L V10 Ford Engines without Damage.

Interchangeable plates ensure drill is centered on the broken stud. Depth gauge for drilling is marked on the template. The stripped screw extractor is then used to remove the broken stud.

68500 Manifold Drill Template for Ford. Molded Case. Shipping wt. 1 lb. 6 oz.

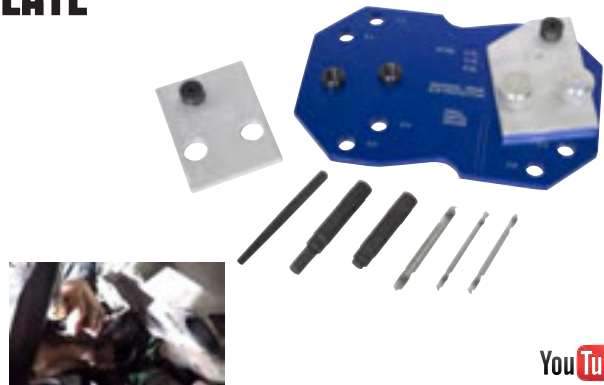

13000 EXHAUST MANIFOLD SPREADER

For Reinstalling the Manifold on Small Block Chevrolets.

A simple way to expand a warped manifold so all bolt holes are accurately aligned. Helps prevent cross-threading of manifold bolts. Works best when used in pairs. Or install before removing manifold to prevent misalignment.

13000 Exhaust Manifold Spreader. Skin-packed. Shipping wt. 6 oz.

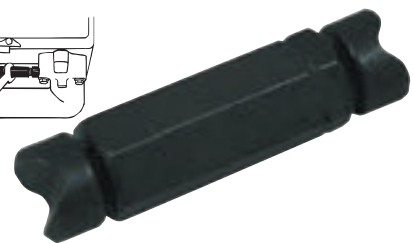
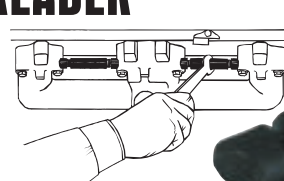

48300 PUSH ROD REMOVER

Redesigned for Newer 3.5L and 3.9L GM Engines. Also Works on 2.8L, 3.1L and 3.4L GM V6 Engines.

Quickly removes push rods so you can replace the intake gasket. No need to loosen and retighten the rocker arm. The tool pivots the rocker arm to compress the valve spring and free the push rod for removal.

48300 Push Rod Remover. Skin packed. Shipping wt. 12 oz.



SUPERSEDES 48500



U.S. Pat No. 9,130,077

20300 VACUUM GAUGE AND FUEL PUMP TESTER

Easy reading gauge assures accurate vacuum and pressure check.

20300 Vacuum Gauge. Skin-packed. Shipping wt. 9 oz.



53760 HARMONIC BALANCER INSTALLER, 12 ADAPTERS

Installs Harmonic Balancers or Drive Pulleys that are Pressed on the Crankshaft.

Set includes driving screw, thrust bearing and 12 threaded adapters necessary to work on a wide range of domestic and some import harmonic balancers. Four long adapters for use on Dodge Hemi, Generation III and IV GM motors, some Ford and some Chrysler. The 1.75" spacer allows the tool to work more effectively on deep harmonic balancers. Comes with detailed instructions and a heavy-duty plastic storage case.

53760 Harm Bal Instal, 12 Adptr. Molded Case. Shipping wt. 5 lbs.

52210 Flanged Nut	52220 Thrust Bearing
52230 Driver	52240 Knurled Nut
52250 Spacer	52270 7/16-20 Adapter
52290 M12x1.5 Adapter	52300 1/2-20 Adapter
52320 M14x1.5 Adapter	52330 9/16-18 Adapter
52340 5/8-18 Adapter	52350 M16x2.0 Adapter
52360 3/4-16 Adapter	53470 Spacer
53480 M14x1.5 Adapter, Long	53490 M16x2.0 Adapter, Long
53770 M12x1.5 Adapter	66720 M12x1.75 Nut
66860 M12x1.75 Stud	



SUPERSEDES 53460



YouTube

ENGINE

57650 ALTERNATOR DECOUPLER PULLEY TOOL KIT

Five Piece Kit for Removing and Installing Many Alternator Decoupler Pulleys on the Most Popular Vehicles in North America.

Includes Two Pulley Sockets and Three Shaft Bits. Kit Works on Both Overriding Alternator Decoupler (OAD) and One-Way Clutch (OWC) Pulleys. Tools can be used while the alternator is on or off the vehicle.

57650 Alternator Decoupler Pulley Tool Kit. Molded Case. Shipping wt. 18.8 oz.

57610 33T Spline Pulley Socket	57620 10mm Female Hex Shaft Bit
57630 17mm Pulley Socket	57660 T-50 Shaft Bit
57670 10mm Triple Square Shaft Bit	



YouTube

60900 HEATER CORE BACKFLUSH TOOL

Adjustable Pressure Industrial Spray Gun and Stepped Tip Design for Easy Heater Core Flushing.

The tip fits 1/2", 5/8" and 3/4" hose fittings. Water pressure can be easily controlled with one hand by squeezing the handle of the heavy-duty spray gun. The insulated handle protects your hand when using hot water to flush the cooling system. The spray gun attaches to a standard garden hose.

60900 Heater Core Backflush Tool. Skin packed. Shipping wt. 13 oz.



77060 77080 77100 77110 77120 77130 HARMONIC BALANCER SOCKETS

Heavy-Duty Impact Sockets Designed with More Than the Standard Socket Mass to Direct More Energy to Removing the Bolt.

77060 has more than two times the standard socket mass. Can be used on Honda engines that use a 17mm hex pulley damper bolt or other 17mm applications. 77080 can be used on Honda engines that use a 19mm hex pulley damper bolt or other 19mm applications. 77100 can be used on Chevy, Chrysler, Dodge, Ford, GM, Jeep & Mazda engines that use a 21mm hex pulley damper bolt or other 21mm applications. 77110 can be used on BMW, Dodge, Ford, Jeep, Kia, Lexus & Toyota engines that use a 22mm hex pulley damper bolt or other 22mm applications. 77120 can be used on Dodge 3.6L engines that use a 27mm hex pulley damper bolt or other 27mm applications. 77130 can be used on 26mm or 1" applications. Heat-treated, impact-quality alloy steel. Use with 1/2" drive.

77060 17mm Harmonic Balancer Socket. Box with Color Label. Shipping wt. 2 lbs.

77080 19mm Harm Bal Sckt Honda. Box with Color Label. Shipping wt. 2 lbs.

77100 21mm Harmonic Balancer Socket. Box with Color Label. Shipping wt. 2 lbs.

77110 22mm Harmonic Balancer Socket. Box with Color Label. Shipping wt. 2 lbs.

77120 27mm Harmonic Balancer Socket. Box with Color Label. Shipping wt. 2 lbs.

77130 26mm Heavy Impact Socket. Box with Color Label. Shipping wt. 2 lbs.

SOCKET	APPLICATIONS
77060	Honda Civic
77080	Honda Accord
77100	Chevy, Chrysler, Dodge, Ford, GM, Jeep & Mazda
77110	BMW, Dodge, Ford, Jeep, Kia, Lexus & Toyota
77120	Dodge 3.6L
77130	26mm or 1" applications



77060



77080



77100



77110



77120



77130

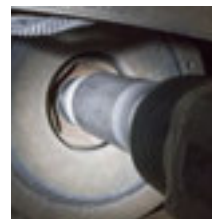

77080 Socket



Standard 19mm Impact Socket

52500 MECHANIC'S STETHOSCOPE

Unique Sound Chamber & Super Thin Diaphragm Greatly Amplifies Sounds.

Quickly pinpoints the source of mechanical noises in engines, transmissions, differentials and bearings.

52500 Stethoscope. Skin-packed. Shipping wt. 6 oz.



52700 AUDIO STETHOSCOPE

Detects Noise From Vacuum Leaks, Exhaust Leaks, Wind Noise & Air Leaks.

Detects air induced sounds not detected by conventional stethoscopes. Place funnel over suspected air leak.

52700 Audio Stethoscope. Skin-packed. Shipping wt. 9 oz.



52750 STETHOSCOPE SET

Dual Purpose Set Detects Both Mechanical & Air Induced Sounds.

Use the black diaphragm chamber & screw-in metal probe to detect mechanical sounds from bearings, engines, transmissions, etc. For air induced sounds, attach the vinyl hose to hollow tube and funnel assembly. The funnel amplifier will detect noises from vacuum leaks, exhaust leaks, air leaks and wind noise. For hard to reach locations, remove the funnel and use the hollow tube.

52750 Stethoscope Set. Clam Shell. Shipping wt. 10 oz.

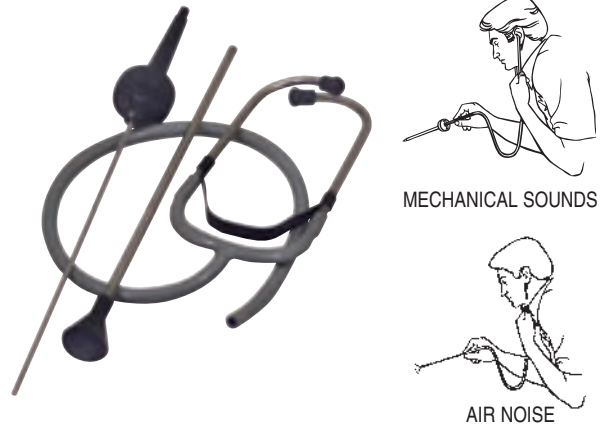

68210 IPR SOCKET FOR FORD 6.0L AND INTERNATIONAL DIESEL

Used to Remove and Replace the Injector Pressure Regulator (IPR) on Ford 6.0L, International and Other Diesel Engines.

The slot in the tool has been modified to fit the larger connectors on injector pressure regulators found on International diesels. On this application the wiring comes out of the top of the regulator. This regulator is located in a very tight location. The tool is built to bottom out on the regulator hex so it does not put torque on the connector in case the regulator can be reused. Use with 3/8" square drive.

68210 IPR Socket for Diesel. Hang Tag. Shipping wt. 8oz.



IMPROVED



24680 SPILL-FREE® FUNNEL

New Clear Funnel Allows a Quick Visual Check of the Coolant from Across the Shop.

Comes with a lid to keep contaminants out as well as store the caps and adapters. Eliminates trapped air pockets which usually cause erratic cooling system and heater performance. It controls the proper amount of coolant entering system and enables unattended filling of the cooling system. The funnel eliminates squeaky belts caused by coolant overflow and protects the environment. Five adapters fit most domestic and import cars and light trucks including newer GM "threaded style" radiator openings and Ford surge tanks. Straight extension and 45° elbows allow use on radiator caps that are placed at an angle or other hard-to-reach applications.

24680 Spill-Free® Funnel. Label. Shipping wt. 1 lb. 3 oz.

21920 Lid 22210 Funnel

22280 45° Elbow 22300 Fluid Stopper

22330 Large Cap A 22340 Medium Cap B

22370 Large Adapter A with Gasket

22390 Medium Adapter B with Gasket

22410 Small Cap C

22450 Small Adapter C with Gasket

24640 Threaded Cap D for GM

24650 Threaded Adapter D with Gasket

24670 Extension

25390 Threaded Adapter E with Gasket



RADIATOR



STRAIGHT NECK APPLICATION



EXTENSION APPLICATION

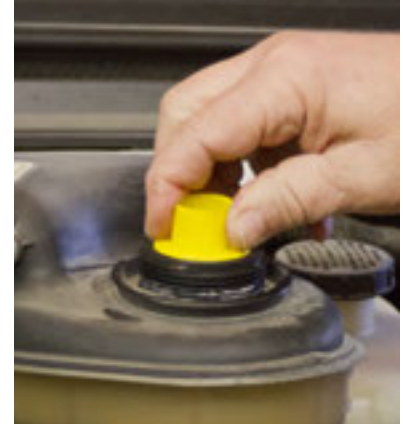

SURGE TANK APPLICATION

51700 HARMONIC BALANCER PULLER SET

Updated Jaw Design On Damper Puller Provides Even Greater Strength. Clevis Pins Allow Jaws To Be Quickly Removed and Replaced.

This kit features the puller hardware and special pulling screws to remove most automotive harmonic balancers.

The kit includes a standard harmonic balancer puller, pulling screws and adapters for 3300 and 3800 GM V6 engines, and our updated harmonic damper pulley puller for Chrysler, GM, Mitsubishi and Dodge.

51700 Harmonic Balancer Puller Set. Shipping wt. 8 lbs.

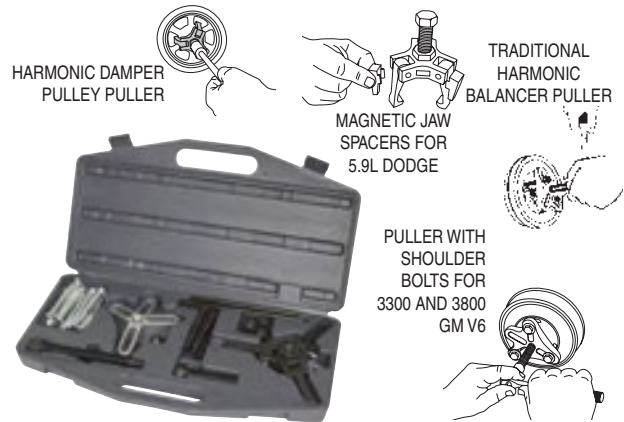

51450 HARMONIC DAMPER PULLEY PULLER

For Chrysler, GM, Mitsubishi and Dodge.

Low profile design works in confined spaces eliminating the need to remove the radiator. Equipped with magnetic jaw spacers for 5.9 liter Dodge. New jaw geometry, slimmer magnetic spacers and a fourth rod allow use on 4.2L Trailblazer, Envoy and Bravada '03 and newer, 4.2L Buick Rainier '04 and newer, 3.5L Colorado and Canyon '04 and newer, Hummer H3 '06 and newer, 2.8L Colorado and Canyon '05 and newer. Jaws are now held in place with a clevis pin and can be removed and replaced easily.

51450 Harmonic Damper Pulley Puller. Clam Shell. Shipping wt. 2 lb. 11 oz.

49520 Clevis Pin	51640 Jaw
51670 Magnet and Housing Assembly	51680 6.5" Rod

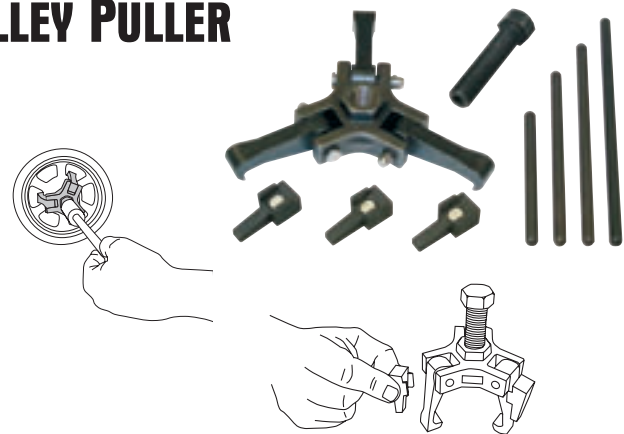

45300 HARMONIC BALANCER PULLER FOR GM

For GM 3300 And 3800 V6 Cylinder Engines.

The 45300 is equipped with the special bolts and adapters to pull the harmonic balancer cleanly without damage to the crank sensor. Order the 45350 Retrofit Kit to use with your Lisle 45500 Harmonic Balancer Puller.

45300 Harmonic Balancer Puller for GM. Boxed. Shipping wt. 2 lbs. 9 oz.

45350 Retrofit Kit for 45500. Mini-pouched. Shipping wt. 8 oz.

45310 Bolt (3)	45320 Adapter
45510 Body	45530 Center Screw



45500 HARMONIC BALANCER PULLER

Helps Stop Damage to Pulley and Shaft.

Designed to ease the operation of pulling the balancer pulley. It reduces damage to both the pulley and the shaft.

45500 Harmonic Balancer Puller. Clam Shell Package. Shipping wt. 3 lbs. 10 oz.

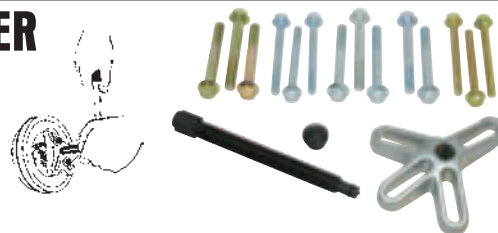

41780 TIMING GEAR PULLER

Pulls Timing Gears as Well as Other Gears with Threaded Holes.

Bar design allows threaded bolts to work with a wide range of threaded hole patterns on gears.

41780 Timing Gear Puller. Skin packed. Shipping wt. 2 lbs.

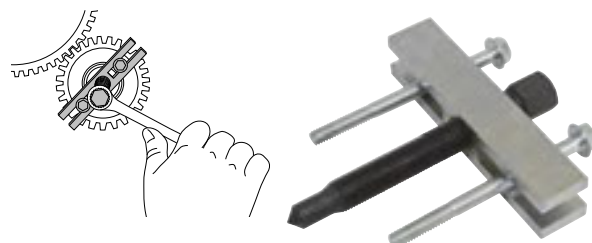

39000 "NO SLIP" PULLEY PULLER/INSTALLER

Removes and Installs Pressed on Power Steering, Alternator and Air Pump Pulleys.

Makes removing pressed on pulleys an easy job. The unique puller body completely houses the pulley hub to prevent slipping on even the tightest pulleys. Fits most domestic models including GM 3.1 and Quad 4 engines. Works on traditional V shaped pulleys and serpentine belt system pulleys. Also works faster than other conventional pulley pullers. Patented design traps the pulley and provides a gripping handle. Tool comes with detailed instructions and a heavy-duty plastic storage case.

39000 "No Slip" Pulley Puller/Installer. Molded Case. Shipping wt. 2 lbs. 2 oz.

38910 Short 3/8"x16 Install. Adapter	38920 Short 8mm Install. Adapter
38930 Med. 3/8"x16 Install. Adapter	38940 Short Pin
38950 Long Pin	38960 Long 3/8"x16 Install. Adapter
38990 Puller Screw	39010 Small Jaw
39020 Large Jaw	39030 Handle
39040 Washer	39050 Nut
39070 Pusher Shaft	40060 Bearing



SUPERSEDES 38850



CUT-AWAY VIEW



U.S. Pat No. 7,007,359

57340 STEERING WHEEL LOCK PLATE TOOL

Fits Domestic Lock Plates, Including Tilt & Telescoping.

Tool depresses lock plate for easy removal of lock ring. Allows access to steering column for repair work. Comes with standard and metric adapters, plus two puller frames. Fits most domestic lock plates, including tilt and telescoping columns. Works on vehicles with air bags.

57340 Steering Wheel Lock Plate Tool. Skin-packed. Shipping wt. 1 lb. 8 oz.

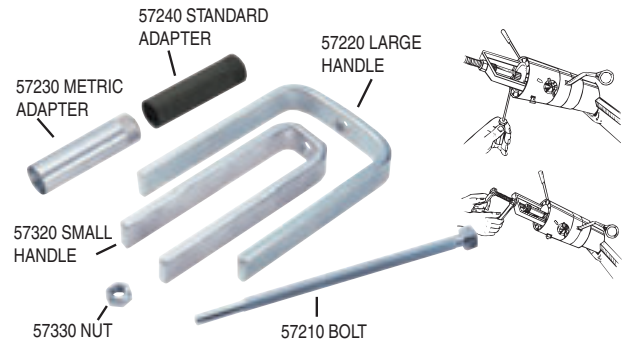

57230 METRIC ADAPTER

57240 STANDARD ADAPTER

57220 LARGE HANDLE

57320 SMALL HANDLE

57330 NUT

57210 BOLT

45000 STEERING WHEEL PULLER

Universal Puller for Most Makes & Models.

Screw pad protects end of steering shaft. Heavy duty for long wear.

45000 Steering Wheel Puller. Clam Shell Package. Shipping wt. 1 lb. 10 oz.

45050 Screw Pad

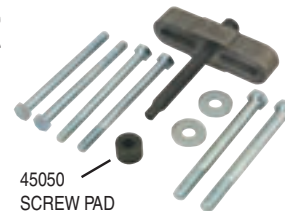

45050 SCREW PAD

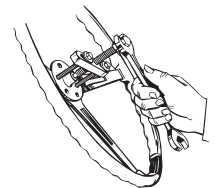

19940 PIVOT PIN REMOVER

Removes the pivot pin on GM, Ford and Chrysler tilt and telescoping Saginaw steering columns. Includes an extra screw.

19940 Pivot Pin Remover. Skin-packed. Shipping wt. 2 oz.

19970 Cap Screw

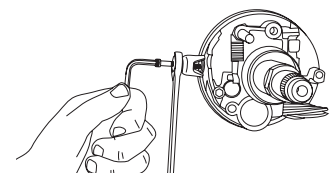

31330 2 OR 3 JAW REVERSIBLE & ADJUSTABLE GEAR PULLER

5-1/2" Reach, 7" Spread & 5 Ton Capacity

This puller is designed for the removal of gears, pulleys, bearing flanges and fly wheels from shafts and/or housings, for the repair and/or replacement of any of these components for removing motor, magneto and generator bearings and gears.

31330 2 or 3 Jaw Reversible & Adjustable Gear Puller. Clam Shell Package. Shipping wt. 2 lb. 15 oz.

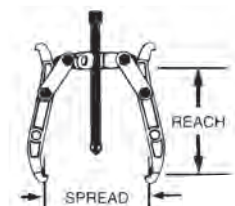

43600 UNIVERSAL FAN CLUTCH WRENCH SET

Three Piece Set Includes a Double-Ended Turning Wrench and Two Holding Wrenches to Fit Most All Applications.

The two pin spanner wrench configurations work on GM, Jeep and Dodge trucks, vans and SUVs with pressed-on water pump pulleys. The double-sided spanner wrench fits two holes in pressed-on water pump pulleys. The universal holding wrench works on all sizes of bolt-on water pump pulleys.

43600 Universal Fan Clutch Wrench Set. Clam Shell Package. Shipping wt. 2 lbs. 13 oz.

43560 36mm - 47mm Fan Clutch Wrench

43570 Universal Holding Wrench

43580 GM/Dodge Holding Wrench



U.S. Pat No. D719,426

FAN CLUTCH

43340 2-1/8" FAN CLUTCH WRENCH

A New 2-1/8" Fan Clutch Wrench for Use with the 43300 Pneumatic Fan Clutch Wrench Set.

Quickly removes and installs the fan clutch when repairing or replacing the water pump or fan clutch. Works without a holding wrench. Use with an air hammer and the 43370 Driving Wrench from the 43300 Pneumatic Fan Clutch Wrench Set to remove and install the fan clutch when repairing or replacing the water pump or fan clutch. The 2-1/8" Fan Clutch Wrench fits the Borg Warner fan clutch found on International Navistar trucks with 13L and 15L Maxforce engines. May fit other 2-1/8" applications.

43340 2-1/8" Fan Clutch Wrench. Mini Pouch. Shipping wt. 14 oz.



U.S. Pat No. 6,354,178

43300 PNEUMATIC FAN CLUTCH WRENCH SET

Updated Driving Wrench Assortment in Case.

Quickly removes and installs fan clutch when repairing the water pump or fan clutch. Faster and easier than conventional fan clutch wrenches. No holding wrench is necessary. Set includes 7 driving wrenches that fit Ford, GM, Chrysler & Jeep. Set now includes 7/8", 32mm, 36mm, 40mm thin and new 47mm size to fit Ford 6.0L and 6.4L Powerstroke diesel pickup. 1-7/8" and 2" are still included in the set. 1-1/2", 41mm and 42mm are still available individually. Use with an air hammer.

43300 Pneumatic Fan Clutch Wrench Set. Molded Case. Shipping wt. 9 lbs. 5 oz.

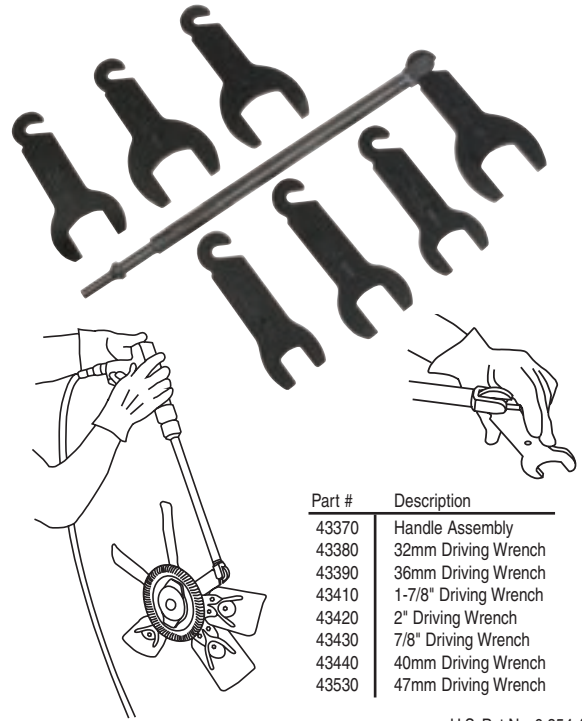

Part #	Description
43370	Handle Assembly
43380	32mm Driving Wrench
43390	36mm Driving Wrench
43410	1-7/8" Driving Wrench
43420	2" Driving Wrench
43430	7/8" Driving Wrench
43440	40mm Driving Wrench
43530	47mm Driving Wrench

U.S. Pat No. 6,354,178

44180 FAN CLUTCH SPANNER WRENCH

For GM, Jeep and Dodge Trucks, Vans and SUVs With Pressed on Water Pump Pulleys.

The double-ended spanner wrench fits the holes in pressed-on water pump pulleys. Hold the pulley firm with the spanner wrench. Use the appropriate open end wrench to turn the fan clutch nut (41740 36mm turning wrench works on many applications).

44180 Fan Clutch Spanner Wrench. Skin-packed. Shipping wt. 2 lbs. 5 oz.

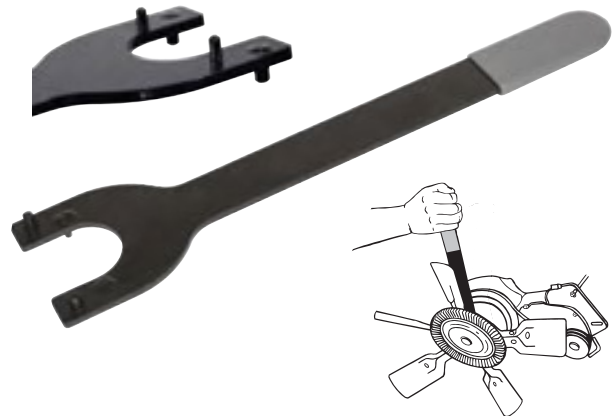

FAN CLUTCH

42920 UNIVERSAL FAN CLUTCH WRENCH SET

Removes Fan Clutch on Most Models.

2-piece set removes & installs fan clutches. Includes a universal holding wrench & a universal turning wrench. Holding wrench is adjustable to fit bolts that attach pulley to the water pump. The turning wrench has the 5 common fan clutch nut sizes built into one tool: 7/8" (22mm), 1-7/16" (36mm), 1-9/16" (39mm), 1-7/8" (47mm) and 2" (50mm).

42920 Universal Fan Clutch Wrench Set. Boxed. Shipping wt. 8 lb. 5 oz.

42930 Turning Wrench.

42940 Holding Wrench.

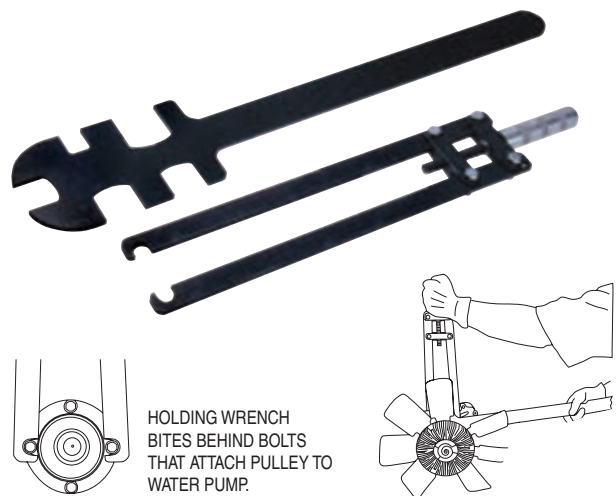

HOLDING WRENCH BITES BEHIND BOLTS THAT ATTACH PULLEY TO WATER PUMP.

39850 MASTER PLUS DISCONNECT SET

A Set of the Most Popular Disconnect Tools in One Handy Molded Case.

Includes fuel line quick connect and spring lock couplings, air conditioning line couplings and transmission oil cooler connectors. All disconnect tools are also available individually.

39850 Master Plus Disconnect Set. Molded Case. Shipping wt. 3 lbs. 4 oz.

11750 Clutch Coupling Remover for Ford

22930 Low Profile 3/8" Jiffy-tite® Disc. 22940 Low Profile 1/2" Jiffy-tite® Disc.

34750 Low Profile Fuel Line Disc. Set 37000 AC/Fuel Line Disc. Set

37300 Fuel & AC Disconnect Pliers 37500 Fuel Module Disc. Tool for GM

39160 Fuel Line Retaining Clip Tool Set

39210 Main Fuel Line Disc. for Toyota & Nissan

39400 Angled Disconnect Set

39660 Trans. Oil Cooler Line Scissors 3/8" x 1/2"

39810 Hydraulic Clutch Line Disc. for GM

39820 Coupler Disc. for Chrysler 39830 Oil Cooler Line Disc. for Ford

39840 Fuel Line Disc. for Ford 39930 5/16" x 3/8" Scissor Disc.

39940 Coupler Disconnect



39900 MASTER DISCONNECT SET

Contains 8 Popular Disconnect Tools for A/C & Fuel Lines.

A complete set of disconnect tools that can be stored in a handy blow-molded case. All disconnect tools are also available individually.

39900 Master Disconnect Set. Molded Case. Shipping wt. 3 lbs. 13 oz.

35000 Flex Fuel Disconnect for GM

37000 AC/Fuel Line Disconnect Set

37500 Fuel Line Quick Disconnect for GM

39400 Angled AC/Fuel Line Disc. Set

39930 5/16" & 3/8" Scissor Disconnect

39940 Coupler Disconnect

39960 Ford Transmission Line Disconnect



37300 FUEL AND AC DISCONNECT PLIERS

Unique Design Provides Extra Leverage When Disconnecting Quick Connect Coupling Air Conditioning and Fuel Lines.

Use with 5/16", 3/8" or 1/2" adapters from the Lisle 37000 or 39400 Disconnect Tool Sets. The forks have different sized openings so the tool can be turned around to fit single or two step collar designed connector lines. The pliers can also be used to reconnect stubborn lines or connections that are in hard-to-reach areas.

37300 Fuel and AC Disconnect Pliers. Skin packed. Shipping wt. 9 oz.

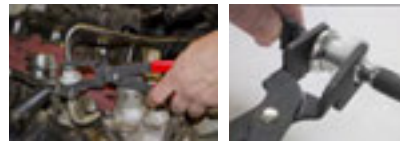

YouTube

39160 FUEL LINE RETAINING CLIP TOOL SET

Compact Tool Design Fits Tight Spaces.

Two sizes, 3/8" and 5/16" are designed to release the nylon retaining clip used on the fuel lines of newer GM and Chrysler vehicles with in tank electric fuel pumps. Includes bead chain for storage.

39160 Fuel Line Retaining Clip Tool Set. Skin-packed. Shipping wt. 1 oz.

39170 5/16" Disconnect Tool 39180 3/8" Disconnect Tool



YouTube

37000 AIR CONDITIONING / FUEL LINE DISCONNECT TOOL SET

Disconnects Air Conditioning and Quick Connect Fuel Lines.

Set disconnects the spring lock couplings on Ford & Chrysler air conditioning lines. Works on fuel line quick connect couplings found on GM, Ford, & Chrysler. The 5/16" size fits on push lock connectors on Ford radiators and transmission lines. Set includes six sizes: 5/16", 3/8", 1/2", 5/8", 3/4" and 7/8".

37000 Air Conditioning / Fuel Line Dis. Tool Set. Skin-packed. Shipping wt. 4 oz.

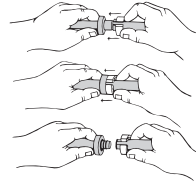

PART#	SIZE
37010	7/8"
37020	3/4"
37030	5/8"
37040	1/2"
37050	3/8"
37060	5/16"



39400 ANGLED DISCONNECT TOOL SET

Disconnects Air Conditioning and Quick Connect Fuel Lines.

Disconnects spring lock couplings on Ford and Chrysler AC lines. Works on fuel lines and other quick disconnect couplings on domestic and import vehicles. The handles are angled to access tight spots. Made of durable plastic that resists fuels and solvents. Six sizes: 5/16", 3/8", 1/2", 5/8", 3/4" and 7/8". Available individually skin-packed.

39400 Angled Disconnect Tool Set. Skin-packed. Shipping wt. 4 oz.

PART#	SIZE
39410	5/16"
39420	3/8"
39430	1/2"
39440	5/8"
39450	3/4"
39460	7/8"

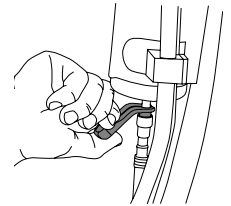

U.S. Pat No. 6,195,862

34750 LOW PROFILE FUEL LINE DISCONNECT SET

Disconnects the Quick Connect Fuel Lines in Hard-to-Reach Locations.

3/8" adapters work on 5.3 liter Suburban, Tahoe, Yukon, Avalanche and select Silverados, Sierras and other GM fuel lines. 5/16" adapters work on Ford and Chrysler applications.

34750 Low Profile Fuel Line Disconnect Set. Skin-packed. Shipping wt. 5 oz.

34740 5/16" Adapter Set

34810 Handle

34830 3/8" Adapter Set

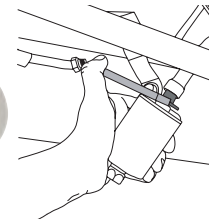

U.S. Pat No. 7,404,245

35000 FUEL FILTER DISCONNECT FOR GM

Disconnects the fuel line from the fuel filter on 5.3L Suburban, Tahoe, Yukon, Avalanche and select Silverados and Sierras. Insert the two semicircular disconnects into the coupling. Connect the handle and depress to separate the fuel line from the filter.

35000 Fuel Filter Disconnect for GM. Skin-packed. Shipping wt. 2 oz.

34810 Handle

34830 3/8" Adapter Set

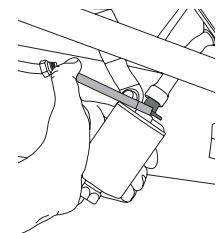

U.S. Pat No. 7,404,245

37500 FUEL MODULE DISCONNECT TOOL FOR GM

Disconnects the Fuel Module on 98 & Later GM Full Size Pickups, Suburban & Tahoe.

Two piece design allows access to the connectors. Slide the proper size end into the connector. Rotate and slide the other half in place. Now the module can be disconnected. Fits both 3/8" and 5/16" connector sizes. Will fit all other 3/8" and 5/16" applications. Clip together for convenient storage.

37500 Fuel Module Disconnect Tool for GM. Skin-packed. Shipping wt. 1 oz..

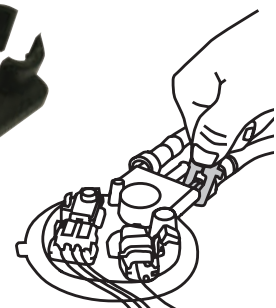

U.S. Pat No. 7,127,787

39210 MAIN FUEL LINE DISCONNECT FOR TOYOTA AND NISSAN

Disconnects the 5/16" Main Fuel Line from the Fuel Rail on Many Toyota and Nissan Vehicles.

Hinged design and fully tapered end allow tool to be quickly and easily inserted into fuel line quick connector, even in hard-to-reach areas. Works on Toyota Echo, Scion xB, xA, TC, Solara, Corolla, Sequoia, Celica, RAV 4, Prius, Camry, MR2, Matrix, Tundra and Highlander. Also for 2004 and newer Nissan models with a 5/16" fuel rail.

39210 Main Fuel Line Disc. for Toyota and Nissan. Skin-packed. Shipping wt. 2 oz.

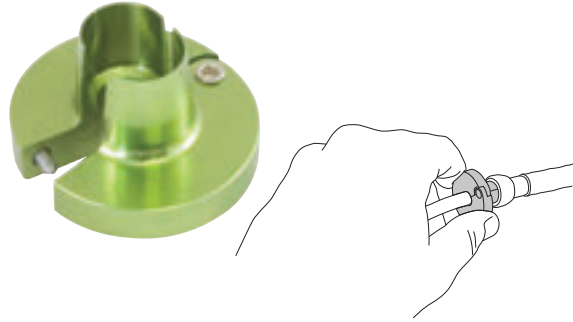

63800 SPRING LOCK COUPLER DISCONNECT SET, 7PC.

Set of Seven Disconnect Tools for Spring Lock Connectors on A/C and Fuel Lines Found on Many Chrysler and Ford Vehicles.

The tools are color coded for sizing and spring loaded to remain on the A/C or fuel line.

63800 Spring Lock Disc Set, 7pc. Hang Card. Shipping wt. 4 oz.

63740 Spring Lock 3/8" Red

63750 Spring Lock 3/8" Yellow

63760 Spring Lock 1/2" Blue

63770 Spring Lock 1/2" Green

63780 Spring Lock 5/8" Shrt Black

63790 Spring Lock 5/8" Long Black

63810 Spring Lock 3/4" White



63730 SCISSOR DISC AC / FUEL LINE SPRING LOCK

Releases Four Sizes of Spring Lock Couplings on A/C and Fuel Lines.

The tool fits four spring lock sizes: A-3/4", B-5/8", C-1/2", and D-3/8" found on many Chrysler and Ford vehicles.

63730 Scissor Disc Tool 4 Size. Skin Packed. Shipping wt. 4 oz.



63710 63720 SCISSOR DISCONNECTS LOW PROFILE

Low Profile, Double-Ended Tools Disconnect Fuel Lines on Many Chrysler, Ford, and GM Vehicles.

The 1/2" side on the 63710 is especially useful for removing the fuel supply line from the sending unit on 2001 and newer Chevrolet/GMC 3/4-ton and 1-ton trucks equipped with 6.6L Duramax engine. The 3/8" side of the 63720 is especially useful for removing the fuel supply line from the center port of the sending unit on 2000 and newer Chevrolet/GMC Suburban and Tahoe/Yukon. Also 1999 and newer Chevrolet Silverado pickups equipped with gas engines.

63710 Scissor LP 3/8" x 1/2". Skin packed. Shipping wt. 2 oz.

63720 Scissor LP 5/16" x 3/8". Skin packed. Shipping wt. 2 oz.



63000 FUEL TANK LOCK RING TOOL

A Rugged Tool To Remove and Install Plastic Fuel Tank Lock Rings from 4" to 7-1/4" Without Damage.

Channel Design on body allows the legs to adjust to fit a wide range of applications and keeps the drive centered. Works on the new smaller GM serrated rings and traditional rings. The design is compact so the tool is not left hanging over the work area with the potential for hitting other components.

63000 Fuel Tank Lock Ring Tool. Skin-packed. Shipping wt. 1 lbs. 6 oz.

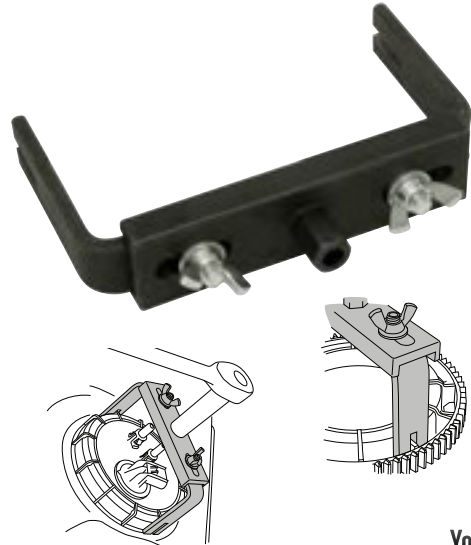

YouTube

55700 MASTER FUEL INJECTION TEST SET

Test All Types of Fuel Injection Systems.

Checks fuel pressure on most Port Fuel Injection (PFI) and Throttle Body Injection (TBI) systems. Comes with adapters & gauges for checking many types of systems. Adapts to work with test port, end of hose & in-line connections. Tests GM, Ford, Chrysler, Honda/Acura, Toyota, Bosch CIS & L-Jetronic.

55700 Master Fuel Injection Test Set. Plastic case. Shipping wt. 10 lbs.



58600 BASIC FUEL INJECTION TEST SET

This set checks fuel pressure on most domestic (except GM TBI) and Japanese Fuel Injection and Throttle Body Injection Systems. Tests the following: Bosch AFC, MPC, Digijet/Digifant - except C.I.S.; Chrysler; Ford; GM - except T.B.I.; Japanese Fuel Injection Systems; others using Bendix-type fuel injection or Schrader-type valve including the small Schrader valve found on Ford.

58600 Basic Fuel Injection Test Set. Plastic case. Shipping wt. 4 lbs.



52990 SPARK PLUG PLIERS

Two Pulling Positions Help Make Removing Spark Plug Wires a Safe and Easy Job.

Specially shaped, cushioned jaws grip the boot straight on or from the side. Plastic handle grips help prevent shock.

52990 Spark Plug Pliers. Skin-packed. Shipping wt. 8 oz.



51750 ADJUSTABLE SPARK PLUG WIRE PULLER

Jaws Adjust to Five Positions.

Plier jaws adjust to five different positions allowing easier access to spark plug boots. Specially shaped, cushioned jaws grip the boot straight on or from the side. Plastic handle grips help prevent shock.

51750 Adjustable Spark Plug Wire Puller. Skin-packed. Shipping wt. 10 oz.

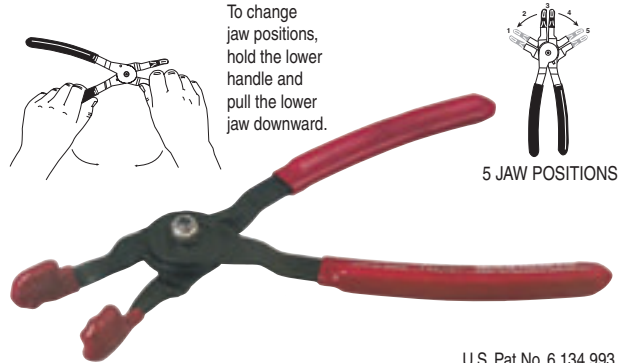

U.S. Pat No. 6,134,993

51410 SPARK PLUG WIRE REMOVAL PLIERS

Used to Remove Stubborn Spark Plug Wires on GM 3.1L, 3.4L, 3.8L and Other Engines.

The 5/8" opening of the pliers properly fits spark plug wire boots to prevent damage to spark plug wires. Tool is 7" long with offset tip to fit in tight spots.

51410 Spark Plug Wire Removal Pliers. Skin Pack Card. Shipping wt. 8 oz.



51420 OFFSET SPARK PLUG WIRE REMOVAL PLIERS

Used to Remove Stubborn Spark Plug Wires.

The 5/8" opening of the pliers properly fits spark plug wire boots to help prevent damage. Offset design works great on boots with heat sleeves found on some GM engines. Easy-to-use in tight spaces such as rear boots on V6 transverse mounted engines. Pliers can also be used on hoses and for holding other objects.

51420 Offset Spark Plug Wire Removal Pliers. Skin Pack Card. Shipping wt. 8 oz.



51250 SPARK PLUG WIRE PULLER

Removes Spark Plug Wire Boots from Plugs.

A simple, yet effective tool for disengaging spark plug wire boots. Tool performs well in difficult areas such as recessed and obstructed plugs. Square shaft prevents slipping. Thick plastic handle prevents electric shock & provides greater pulling power.

51250 Spark Plug Wire Puller. Skin-packed. Shipping wt. 4 oz.

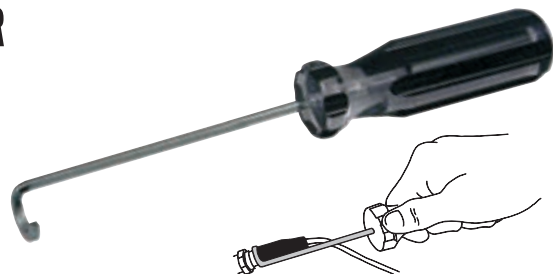

50850 IGNITION SPARK TESTER

Quickly Checks Spark at Plug Wire.

A handy tool to check ignition spark without removing the spark plug. The tool is specially calibrated to measure ignition voltage. Works on both standard and electronic ignition systems. Simply adjust calibration screw to proper gap size. Attach spark plug wire to end of tester. Clamp tester on engine to ground. Crank engine and check for spark.

50850 Ignition Spark Tester. Skin-packed. Shipping wt. 2 oz.

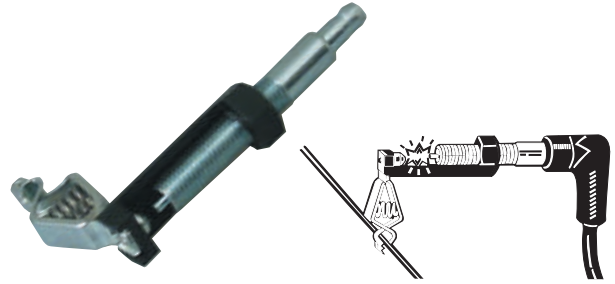

20700 COIL-ON-PLUG SPARK TESTER

Provides an Easy Way to Check Ignition Systems with Coil-On Plugs. Applications Include Ford, Chrysler, Mitsubishi, Nissan and More.

It is the quickest way to test for no-start conditions. An inductive test cannot be performed, because there are no plug wires. High visibility white lettering makes it easy to read the gap measurement from 0 to 40k. The round knob provides easy gap adjustment and the 12" ground wire comes with a shielded clip. The standard plug wire tip can be unscrewed so the tester can be used on small engines and some motorcycles.

20700 Coil-On-Plug Spark Tester. Skin packed. Shipping wt. 4 oz.



51500 SPARK PLUG WIRE PULLER

Nylon Stops the Shocks and Beats the Heat and Burns.

Helps you pull spark plug wires quickly, easily and without damage to the wire or rubber boots.

51500 Spark Plug Wire Puller. Skin-packed. Shipping wt. 2 oz.

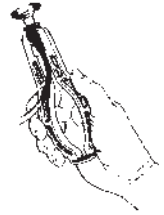
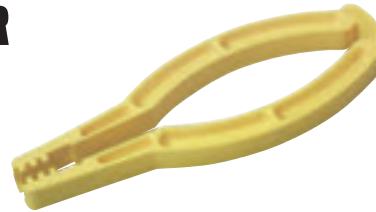

51600 SPARK PLUG WIRE PULLER

Also Pulls Cartridge Fuses.

Jaws are made to pull spark plug boots from different angles. The double-ended tool also pulls cartridge fuses up to 1" in diameter. Made of glass-filled nylon for shock resistance and extra strength.

51600 Spark Plug Wire Puller. Skin-packed. Shipping wt. 3 oz.



20200 SPARK PLUG HOLE AND OXYGEN SENSOR THREAD CHASER

Double-Ended for Both 14mm & 18mm Threads.

Cleans threads in spark plug holes, also oxygen sensor holes. Use with 3/4" spark plug socket.

20200 Spark Plug Hole Thread Chaser. Skin-packed. Shipping wt. 5 oz.

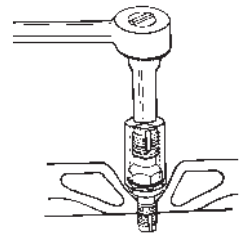

20020 LIMITED ACCESS SPARK PLUG CHASER M14X1.25

Fits Spark Plug Holes with Limited Access.

The narrow profile and long length allows access to spark plug holes in confined spaces. Use with a 3/8" ratchet or extension. Size: M14x1.25. IMPORTANT: Use anti-seize.

20020 Limited Access Spark Plug Chaser. Skin-packed. Shipping wt. 3 oz.

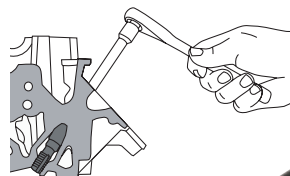

20610 INLINE SPARK TESTER

Gives a Visual Check of the Ignition System.

Quickly diagnose problems with all ignition systems. Connect the tool between the spark plug and the plug wire. The tool is double-ended to offer a straight boot and a 90° boot on one tool. With the engine running, the tool flashes a mirror image of ignition spark.

20610 Inline Spark Tester. Skin-packed. Shipping wt. 5 oz.

20680 Replacement Bulb



U.S. Pat No. 6,714,015

19380 SPARK INDICATOR

Tests Spark Plugs, Spark Plug Wires and Coils Without Puncturing the Wire.

With the engine running, place the grooved end of the aluminum tool over the plug wire. The bulb will flash to indicate spark.

19380 Spark Indicator. Skin-packed. Shipping wt. 1 oz.

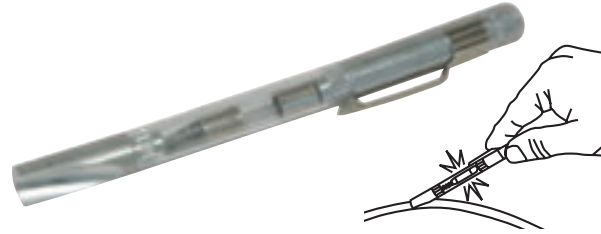

26900 SPARK PLUG WIRE TESTER

Quickly Locate Faulty Plug Wires. No Shock Hazard.

Now you can check spark plug wires without piercing the wires. Light flashes indicating sound wire.

26900 Spark Plug Wire Tester. Skin-packed. Shipping wt. 2 oz.

19370 Replacement Bulb



20750 REMOTE STARTER

Tough, Smooth-working, Reliable Switch.

Features heavy gauge, rubber-covered copper wire. Depress button to jog or start the engine.

20750 Remote Starter. Skin-packed. Shipping wt. 6 oz.



55250 CARBURETOR ADJUSTING TOOL

Heavy-duty flexible shaft for easy access.

Four adapters with vinyl holder for storage.

55250 Carburetor Adjusting Tool Skin-packed. Shipping wt. 5 oz.

55300 "Double D" for GM, '79 thru present.

55310 1/4" Hex for pre-'78 GM.

55320 3/32" Hex for '78 through present Chrysler 1.7L - 2.2L engines.

55330 4.5mm Hex for '78 and '79 GM.

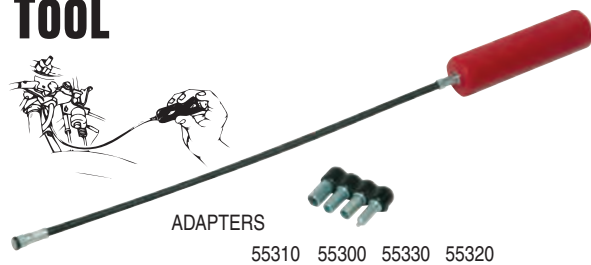

ADAPTERS

55310 55300 55330 55320

75000 VACUUM PUMP

Heavy Duty Pump that is Field Repairable.

The pump is made of one-piece zinc die cast material for durability and improved performance. Checks all vacuum operated components on car. Pump comes with a detailed, illustrated manual covering vacuum testing. Worn o-rings, seals and valves can be replaced with the 75400 repair kit.

75000 Vacuum Pump. Skin-packed. Shipping wt. 1 lb. 10 oz.

75400 Vacuum Pump Repair Kit. Bagged. Shipping wt. 1 oz.

CHECKING VACUUM
ADVANCE CHAMBER



CHECKING
EGR VALVE



70160 GAUGE

22990 4 PC. LOW PROFILE JIFFY-TITE® DISCONNECT SET

Low Profile Design Quickly and Easily Disengages the Line from Jiffy-tite Quick-Connect Fittings without Removal of the Clip.

The teeth of the tool fit perfectly into the tight tolerance of Jiffy-tite® connectors and when rotated allow the line to be pulled without damage to the connector or retaining clip so they can be reused. Includes four sizes: 3/8", 1/2", 5/8"-30% and 5/8"-39%. All sizes are available individually.

22990 4 Pc. Low Profile Jiffy-tite® Disconnect Set. Molded Case. Shipping wt. 9 oz.

22930 Low Profile 3/8" Jiffy-tite® Disconnect

22940 Low Profile 1/2" Jiffy-tite® Disconnect

22950 Low Profile 5/8"-30% Jiffy-tite® Disconnect

22960 Low Profile 5/8"-39% Jiffy-tite® Disconnect

22970 Low Profile 3/4" Jiffy-tite® Disconnect (available individually)



22930 3/8" JIFFY-TITE® DISCONNECT 22920 8MM JIFFY-TITE® DISCONNECT

Low-Profile Design Quickly and Easily Disengages Jiffy-tite Quick-Connect Fittings Without Removal of the Clip.

Teeth of the tool fit perfectly into tight tolerance of Jiffy-tite® connectors and when rotated allow the line to be pulled without damage to the connector or retaining clip so they can be reused. 22930 fits the most popular Jiffy-tite® fittings used in newer GM vehicles, many newer Daimler Chrysler and some newer Mercedes vehicles. 22920 works on 8mm Jiffy-tite connectors found on turbo cooling lines on 3.6L GM LF3 engines and some European vehicle engines.

Fittings are found on oil cooler lines used on transmissions and radiators and on other applications. Also found on Harley-Davidson V-Rod.

22930 3/8" Jiffy-tite® Disconnect. Skin packed. Shipping wt. 3 oz.

22920 8mm Jiffy-tite® Disconnect. Skin packed. Shipping wt. 1 oz.



22710 DISCONNECT SET FOR JIFFY-TITE® CONNECTORS

Disengages the Line from Jiffy-tite Quick-Connect Fittings Without Removal of the Clip.

Handy spring-action of the stainless steel tool keeps the tool on the line. Teeth of the tool fit perfectly into tight tolerance of Jiffy-tite® connectors so they can be reused.

22710 Disconnect Set For Jiffy-Tite® Connectors. Shipping wt. 12 oz.

22720 3/8" Jiffy-tite® Disconnect 22730 1/2" Jiffy-tite® Disconnect

22740 5/8" 39% Jiffy-tite® Disconnect 22750 5/8" 30% Jiffy-tite® Disconnect

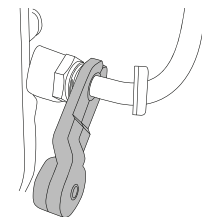

Applications:

1996 and newer GM vehicles
Many 2004 and newer Daimler Chrysler vehicles
Some 2005 and newer Mercedes vehicles
Harley-Davidson V-Rod
Freightliner, Peterbilt, Volvo and White

39960 TRANSMISSION OIL COOLER LINE DISCONNECT FOR FORD

Two Sizes, 3/8" and 1/2" are Designed to Disconnect Transmission Cooler Lines.

Use 3/8" size for '03 - '10 Ford V8 Explorer, '04 and later Ford F150 and Cadillac CS. Use 1/2" size for Ford Super Duty Trucks, F250, F350 and F450. Simply push the line toward the connector, then engage tool and pull line from connector.

39960 Trans. Oil Cooler Line Disconnect for Ford. Skin-packed. Shipping wt. 1 oz.

39910 1/2" Disconnect

39920 3/8" Disconnect

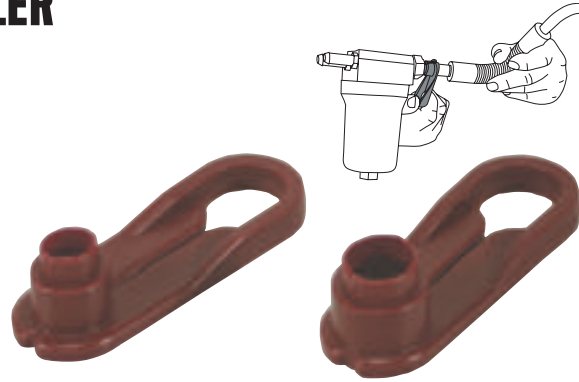

U.S. Pat No. 7,350,282

39660 TRANSMISSION OIL COOLER LINE SCISSORS 3/8" X 1/2"

Stepped Design with Two Sizes to Work on Ford and Cadillac Vehicles.

Similar in function to our 39960 plastic model but made from metal and in a scissor design.

39660 Transmission Oil Cooler Line Scissors 3/8" x 1/2". Skin-packed. Shipping wt. 3 oz.

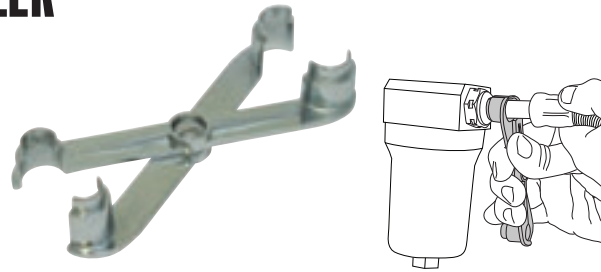

23400 TRANSMISSION/TRANSAXLE PLUGS

Stops Loss of Transmission Fluid.

Stepped plugs fit transmissions and transaxles on most cars and pickups. Stepped design prevents slipping. Plugs cover a range of 1" - 2.180" (25.4mm - 55.37mm).

23400 Transmission Plugs. Clam Shell Package. Shipping wt. 11 oz.

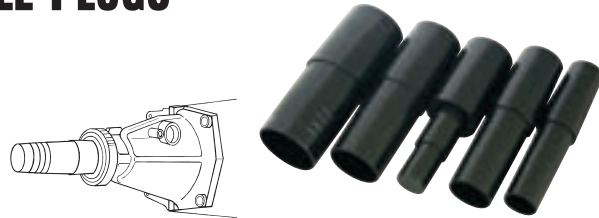

55600 CLUTCH PILOT BUSHING REMOVER

Uses Hydraulic Pressure to Remove Bushings.

Screw the self-tapping tip 2-3 threads into the brass or bronze bushing. Then pump out the bushing with a grease gun. Fits bushings from 1/2" to 3/4" I.D. Not for use on steel bearings. Made of case hardened steel.

55600 Clutch Pilot Bushing Remover. Skin-packed. Shipping wt. 4 oz.

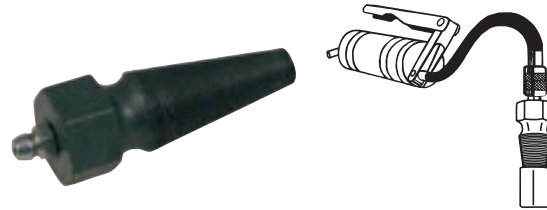

55500 61750 CLUTCH ALIGNMENT TOOLS

Faster, Easier Replacement of Clutches.

55500 shaft and bushings provide an accurate fit for eight pilot bearing sizes. Tapered cone handles the rest. 61750 has a shaft, ten pilot bushings and two plate alignment cones with graduated turned diameters for "automatic" fit of most metric clutch plates. A tapered cone to fit all others is provided.

55500 Clutch Alignment Tool. Clam Shell Package. Shipping wt. 1 lb. 3 oz.

61750 Metric Clutch Alignment Tool. Clam Shell Package. Shipping wt. 15 oz.

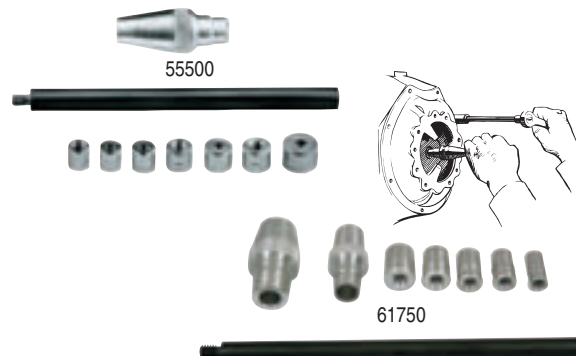

57010 57020 57030 57040
SWIVEL-GRIPPER™
“NO-SLIP” FILTER WRENCH

Tough, Stainless Steel Band with Permanently Bonded Textured Coating for Superior Gripping Power...won't Slip.

Swivel handle makes it easy to turn in tight spots. Handle swivels more than 180° with adjustable tension. Tension adjusting nut allows swivel pressure to be regulated — no more floppy filter wrenches. Patented coating process adds many additional gripping points to securely grab the filter. Extra Small Swivel-Gripper has a special narrow 1/2" band to fit into tight places. Can also be used on some fuel filters. Large Swivel-Gripper fits many tractors and other farm implement products.

57010 Extra Small Swivel-Gripper. Range 2.375" - 2.625" (60.3 - 66.7mm).

Skin-packed. Shipping wt. 12 oz.

57020 Small Swivel-Gripper. Range 2.875" - 3.25" (73 - 82.5mm).

Skin-packed. Shipping wt. 12 oz.

57030 Standard Swivel-Gripper. Range 3.5" - 3.875" (88.9 - 98.4mm).

Skin-packed. Shipping wt. 13 oz.

57040 Large Swivel-Gripper. Range 4.125" - 4.5" (104.7 - 114.3mm).

Skin-packed. Shipping wt. 13 oz.



Gripping Texture

Swivels More Than 180°

Tension Adjusting Nut

U.S. Pat No. 8,573,094

53200 53250 53500 53700
54200 54300 54400 “SWIVEL GRIP” OIL FILTER WRENCHES

Handle Swivels to Clear Obstructions.

All models feature the swivel handle, gripper “teeth” and 1" wide stainless steel band. The swivel handle makes it easy to turn filters in hard to reach locations. Vinyl covered handle.

53200 John Deere Oil Filter Wrench. Range 4.75" - 5.1875" (120.7 - 131.8mm).

Skin-packed. Shipping wt. 14 oz.

53250 Large Swivel Grip Oil Filter Wrench. Range 4.125" - 4.5" (104.7 - 114.3mm).

Skin-packed. Shipping wt. 12 oz.

53500 Standard Swivel Grip Oil Filter Wrench. Range 3.5" - 3.875" (88.9 - 98.4mm).

Skin-packed. Shipping wt. 12 oz. NSN 5120-00-228-6287

53700 Small Swivel Grip Oil Filter Wrench. Range 2.875" - 3.25" (73 - 82.5mm).

Skin-packed. Shipping wt. 12 oz.

54200 Oil Filter Wrench for Cummins & Detroit Diesel Engines.

Range 4.3125" - 4.75" (109.5 - 120.7mm). Skin-packed. Shipping wt. 13 oz.

54300 Oil Filter Wrench for Caterpillar Engines. Range 5.25" - 5.75"

(133.5 - 146mm). Skin-packed. Shipping wt. 14 oz.

54400 Swivel Grip Oil/Fuel Filter Wrench. Range 2.375" - 2.625" (60.3 - 66.7mm).

Skin-packed. Shipping wt. 11 oz.

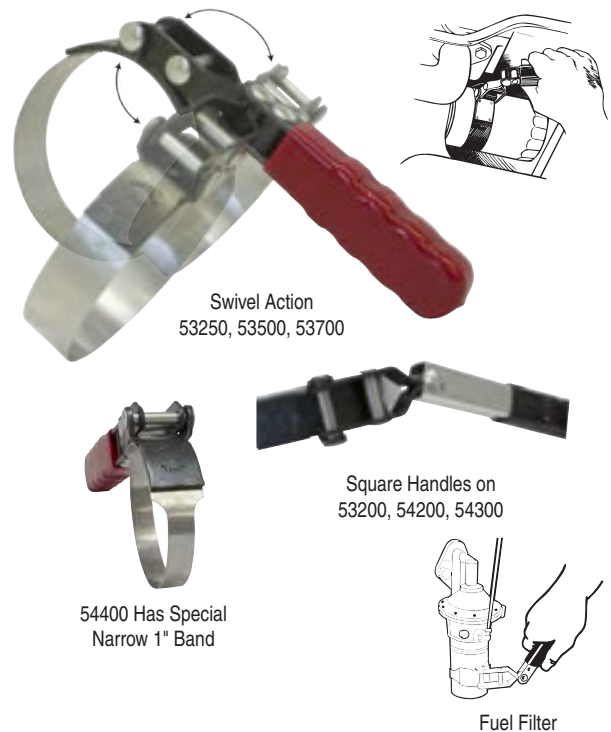

Swivel Action
53250, 53500, 53700

Square Handles on
53200, 54200, 54300

54400 Has Special
Narrow 1" Band

Fuel Filter

53900 FILTER WRENCH
Straight Handle Filter Wrench.

1" stainless steel band with special “teeth” grips tightly. Vinyl-covered handle provides firm, comfortable grip.

53900 Filter Wrench. Range 3-1/2" to 3-7/8" (88.9 - 98.4mm). Skin-packed. Wt. 11 oz

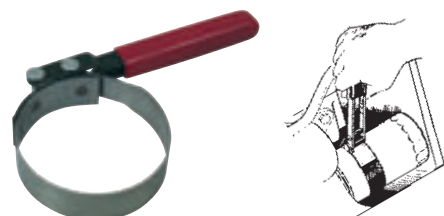

61450 10 PC. HEAVY DUTY END CAP FILTER WRENCH SET
61500 17 PC. HEAVY DUTY END CAP FILTER WRENCH MASTER SET

Heavy Duty Design with a Welded Steel Plate for Strength.

Two collections of end cap filter wrenches to fit the most popular domestic and import vehicles.

61450 10 pc. Heavy Duty End Cap Filter Wrench Set.

Molded Case. Shipping wt. 4 lbs. 15 oz.

61500 17 pc. Heavy Duty End Cap Filter Wrench Master Set.

Molded Case. Shipping wt. 7 lbs. 12 oz.

61510 93mm-45 flutes	61520 73/74mm-14 flutes
61530 82mm-15 flutes	*61540 65/67mm-14 flutes
*61550 80mm-15 flutes	*61560 74/76mm-15 flutes
*61570 76mm-14 flutes	*61580 93mm-15 flutes
*61590 93mm-36 flutes	*61600 65mm-14 flutes
61610 86mm-14 flutes	61620 88.4mm-15 flutes
61630 96mm-18 flutes	61640 68mm-14 flutes
61650 76mm-30 flutes	61660 86mm-16 flutes
61670 100mm-15 flutes	

*Available hang tag packaged for display. Others are available mini-pouched.



SUPERSEDES 54920

61450 Includes:

61540	61550	61560
61570	61580	61590
61600	61640	61650
61660		

61500 Includes:

61510	61520	61530
61540	61550	61560
61570	61580	61590
61600	61610	61620
61630	61640	61650
61660	61670	

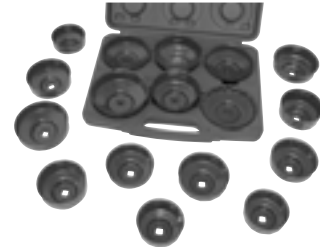

SUPERSEDES 54880



SECURE WELDS ON STEEL PLATE

FILTER

13300 5 PC. FILTER SOCKET SET
14650 3 PC. FILTER SOCKET SET

Set of 5 Low Profile Oil and Fuel Filter Canister Sockets in One Handy Case.

Contains very low profile, 6 point 24mm, 27mm, 29mm, 32mm and 35/36mm sockets for use on oil and fuel filter canisters when replacing the element. Use with 3/8" drive. 5 pc. Set includes:

- 13310** - 24mm for Cadillac and some BMW
- 13320** - 27mm for 2003 and later Mercedes 1.8L, Smart and some VW
- ***14500** - 35/36mm for Ford 6.0L Diesel Fuel and Oil Filter Housings, Mini Cooper and some BMW Oil Filter Housings, and Mack Truck Oil Filter Housing
- ***14600** - 29mm (1-1/8") for Dodge Cummins Fuel Filter Housing
- ***14700** - 32mm (1-1/4") for GM Ecotec, 2.0L, 2.2L and 2.4L Four Cylinder Oil Filter Housing; Some Saturn & Saab

13300 5 Pc. Filter Socket Set. Molded Case. Shipping wt. 1 lb. 13 oz.

14650 3 Pc. Filter Socket Set. Molded Case. Shipping wt. 1 lb. 6 oz.

*Available individually packaged for display. Others are mini-pouched.



14650 3 PC. FILTER SOCKET SET
Includes: 14500 14600 14700

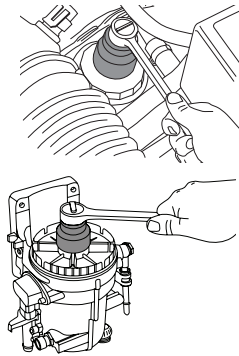

60200 HEAVY DUTY STRAP FILTER WRENCH

A Heavy-Duty Heat Treated Alloy Steel Yoke and Strong Web Strap.

Use with 1/2" drive to remove or install filters and other objects up to 6-1/2" in diameter. 3-5/8" long yoke fits into tight areas.

60200 Heavy Duty Strap Filter Wrench. Skin-packed. Shipping wt. 8 oz.



63250 63600 FILTER WRENCHES

63250 Range from 3-1/8" to 3-7/8".
63600 Range from 2-1/2" to 3-1/8".

Steel jaws grip filter without slipping. Works in tight spots from the front of the filter using 3/8" drive.

63250 Wide Range Filter Wrench. Skin-packed. Shipping wt. 14 oz.

63600 Import Car Filter Wrench. Skin-packed. Shipping wt. 14 oz.

63630 Replacement Spring

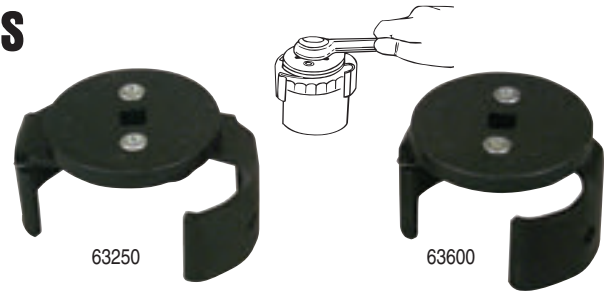

50750 50950 OIL FILTER PLIERS

Two Position, Slip Joint Handle for Greater Range. 50750 Range from 2-1/4" to 4". 50950 Range from 3-5/8" to 6".

Sure grip teeth prevent slipping. Cushioned handles provide comfort.

50750 Oil Filter Pliers. Skin-packed. Shipping wt. 1 lb. 5 oz.

50950 Truck and Tractor Oil Filter Pliers. Skin-packed. Shipping wt. 1 lb. 13 oz.

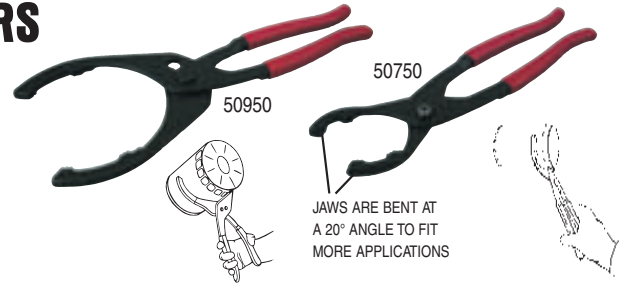

53100 ADJUSTABLE OIL FILTER WRENCH

For Trucks and Tractors. Fits John Deere, Case, Caterpillar, Mack, Detroit Diesel and Others.

Tough, stainless steel band adjusts for extra range... won't slip. Professional quality. 1/2" square drive. Range 4-3/8" - 5-5/8" (111.1 - 142.8mm).

53100 Adjustable Oil Filter Wrench. Skin-packed. Shipping wt. 14 oz.

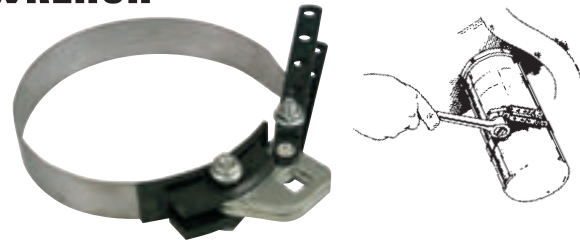

53400 UNIVERSAL 3" OIL FILTER WRENCH

Remove and Install All 3" Filters.

Works in the tightest spots. Stainless steel band, gripper teeth...won't slip. 3/8" square drive.

53400 Universal 3" Oil Filter Wrench. Skin-packed. Shipping wt. 8 oz.

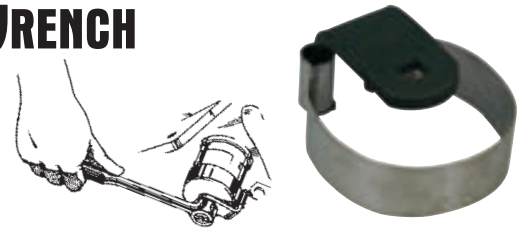

63500 "BIG RANGE" FILTER WRENCH

For Filters Up to 6" (152.4mm).

Adjusts quickly to fit any spin-on oil filter up to 6" diameter. Use with 1/2" drive or 3/4" wrench. Strong polypropylene belt.

63500 Big Range Filter Wrench. Skin-packed. Shipping wt. 10 oz.

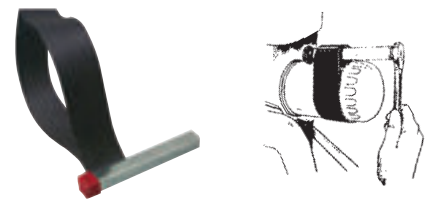

58850 OIL PAN PLUG RETHRADING KIT

Removes Damaged Thread and Taps a New Oversize Thread.

This set includes a piloted drill, spring-loaded tapping tool and 5 magnetic drain plugs. The unique tapping tool ensures the new thread will be perpendicular to the gasket surface to prevent leakage. Works on soft steel and aluminum oil pans with 1/2", 12mm & 14mm threads. Can be used on the vehicle when room permits.

58850 Oil Pan Plug Retreading Kit. Molded Case. Shipping wt. 2 lb. 1 oz.

58650 Plugs & Gaskets (Set of 5)

58880 Piloted Drill Assembly

58900 Tap

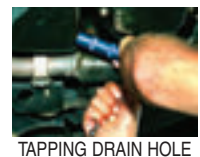

26550 27200 27740 TORX® BIT SETS

Sizes for Most Applications, T-10 through T-60.

All Torx® bits are made of heat-treated alloy steel.
26550 - 9 pc. set includes T-10 through T-50.

Our 27200 - 12 pc. set includes the same bits as our 9 pc. set, plus the T-47, T-55 & T-60 bits. 27740 - 3 pc. set includes T-40, T-45, & T-50 sizes for servicing disc brakes fitting GM & Ford brake caliper Torx bolts. T-10 through T-30 are 1/4" drive. T-40 through T-55 are 3/8" drive. T-60 is 1/2" drive.

26550 9 Piece Torx® Bit Set. Skin-packed. Shipping wt. 8 oz.

27200 12 Piece Torx® Bit Set. Skin-packed. Shipping wt. 15 oz.

27740 Brake Caliper Torx® Bit Set. Skin-packed. Shipping wt. 5 oz.

*Both sets in convenient vinyl holder. All bits are available individually skin-packed.

26550 Includes:

Part No.	Torx Size
26560	T-10
26570	T-15
26580	T-20
26590	T-25
26600	T-27
26610	T-30
26620	T-40
26630	T-45
26640	T-50

27740 Includes:

Part No.	Torx Size
26620	T-40
26630	T-45
26640	T-50

27200 Includes:

Part No.	Torx Size
26560	T-10
26570	T-15
26580	T-20
26590	T-25
26600	T-27
26610	T-30
26620	T-40
26630	T-45
26500	T-47
26640	T-50
26650	T-55
26520	T-60



27530 T-70 TORX® BIT

Fits the Torque Converter Drain Plug.

Works on 2003 and later Subaru Legacy, Forester, Impreza and brake rotor retaining bolts on GM C4500 trucks. 1/2" drive.

27530 T-70 Torx® Bit. Skin-packed. Shipping wt. 4 oz.



82200 82300 SUPER TORX® BIT SOCKET SETS

Two-Piece Design is 20% Stronger Than One-Piece Torx Bits.

13 of the most popular Torx® sizes in two sets for many automotive applications. Made with heat-treated S2 alloy steel.

82200 Super Torx® Bit Socket Set, 9 pc. Skin Pack Card. Shipping wt. 10 oz.

82300 Super Torx® Bit Socket Set, 4 pc. Skin Pack Card. Shipping wt. 13 oz.

*Both sets in convenient vinyl holders. All bits are available individually.



82200 Includes:

Part No.	Torx Size	Drive Size
82210	T-10	1/4"
82220	T-15	1/4"
82230	T-20	1/4"
82240	T-25	1/4"
82250	T-27	1/4"
82260	T-30	1/4"
82270	T-40	3/8"
82280	T-45	3/8"
82290	T-50	3/8"



82300 Includes:

Part No.	Torx Size	Drive Size
82310	T-47	3/8"
82320	T-55	3/8"
82330	T-60	1/2"
82340	T-70	1/2"

27490 E-4 TORX® SOCKET

For Electrical Ignition Switches On GM.

This extra deep socket is used on some General Motors ignition switches, 1/4" drive.

27490 E-4 Torx® Socket. Skin-packed. Shipping wt. 1 oz.

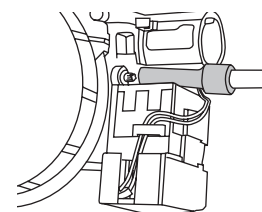

TORX®

26280 26750 TORX® SOCKET SETS

For External Torx® Bolts.

26280 includes 10 sizes, E5 through E20. The four smaller sizes are 1/4" drive; the next four sizes are 3/8" drive; the two largest sizes are 1/2" drive.

26750 has seven sizes E-6 thru E-16. The three smaller sizes are 1/4" drive; the four larger sizes are 3/8" drive.

Made of heat-treated alloy steel. Sockets are kept in a convenient vinyl holder.

26280 Torx® Socket Set. Skin-packed. Shipping wt. 1 lb.

26750 Torx® Socket Set. Skin-packed. Shipping wt. 9 oz.



Part No.	Torx Size	Bolt Size
26770	E-5	#8, 4mm
26780	E-6	#10, 5mm
26790	E-7	5/16 stud
26800	E-8	#12 & 1/4", 6mm
26820	E-10	5/16", 8mm
26830	E-12	3/8", 10mm
26840	E-14	7/16", 12mm
26850	E-16	1/2"
26860	E-18	9/16", 14mm
26870	E-20	5/8", 16mm

SET INCLUDES CONVENIENT VINYL HOLDER

ALL SOCKETS ARE AVAILABLE INDIVIDUALLY SKIN-PACKED

Part No.	Torx Size	Bolt Size
26780	E6	#8
26790	E7	#10
26800	E8	#12 and 1/4"
26820	E10	5/16"
26830	E12	3/8"
26840	E14	7/16"
26850	E16	1/2"

26000 TAMPER RESISTANT TORX® BIT SET

Seven 1/4" Hex Insert Bits with 1/4" Drive Bit Holder. T-10 through T-40.

Fits tamper-resistant Torx® fasteners found on radio mountings, exterior mirrors, carburetors and other applications.

26000 Tamper-Resistant Torx® Bit Set. Skin-packed. Shipping wt. 3 oz.



Part No.	Torx Size
26010	T-10
26020	T-15
26030	T-20
26040	T-25
26050	T-27
26060	T-30
26070	T-40
26080	Bit Holder

26530 MASTER TAMPER RESISTANT TORX® BIT SET

Ten hex insert bits with two bit holders. Includes Torx® sizes T-10 through T-55.

Seven smallest bits are used with the 1/4" bit holder. Three largest bits use the 3/8" bit holder. Convenient vinyl holder.

26530 Master Tamper Resistant Torx® Bit Set. Skin-packed. Shipping wt. 7 oz.

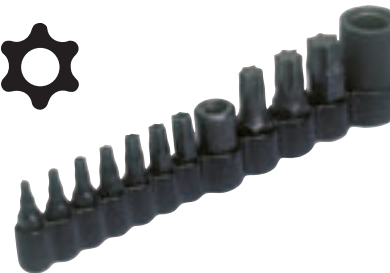

Part No.	Torx Size
26010	T-10
26020	T-15
26030	T-20
26040	T-25
26050	T-27
26060	T-30
26070	T-40
27560	T-45
27580	T-50
27600	T-55
26080	1/4" Bit Holder
27630	3/8" Bit Holder

81000 TORX PLUS® BIT SET

Nine of the Most Popular Torx Plus® Sizes for Automotive Applications.

Torx Plus® drivers will not fit standard Torx® fasteners. Standard Torx® drivers will fit Torx Plus® fasteners, but not to full torque because of the loose fit, and are not recommended. Some common Torx Plus® applications include GM transmission bell housing bolts, Ford seat belt anchors and Ford pick-up bed bolts. Set includes: TP-10, TP-15, TP-20, TP-25, TP-27, TP-30, TP-40, TP-45 and TP-50. Six smaller bits are 1/4" drive and three larger bits are 3/8" drive. Vinyl holder for storage included. All bits plus TP-55 and TP-60 are available individually.

81000 Torx Plus® Bit Set. Skin-packed. Shipping wt. 11 oz.



Part No.	Torx Size
81010	TP-10
81020	TP-15
81030	TP-20
81040	TP-25
81050	TP-27
81060	TP-30
81070	TP-40
81080	TP-45
81090	TP-50
81100	TP-55
81110	TP-60

83100 EXTERNAL TORX PLUS® SOCKET SET

Nine of the Most Popular Torx Plus® Socket Sizes for Automotive Applications.

External Torx Plus® applications include body panels on newer Ford trucks with aluminum bodies and seats on GM trucks. Standard Torx® sockets will not fit Torx Plus® fasteners. Three smaller sockets are 1/4" drive, five sockets are 3/8" drive and largest socket is 1/2" drive.

83100 External Torx Plus® Socket Set. Skin Pack Card. 14 oz.

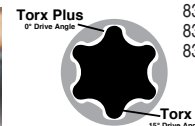

Part No.	Torx Size
83110	EP-6
83120	EP-7
83130	EP-8
83140	EP-10
83150	EP-11
83160	EP-12
83170	EP-14
83180	EP-16
83190	EP-18

13600 33850 HEX BIT SETS

Seven Piece Sets. 3/8" Square Drive.

High strength, heat-treated alloy steel bits are securely braced into chrome plated sockets. No set screws to tighten! Bit sets store in a convenient vinyl holder.

13600 Hex Bit Set. Skin-packed. Shipping wt. 10 oz.

33850 Metric Hex Bit Set. Skin-packed. Shipping wt. 11 oz.

All bits are available individually skin-packed.



13600	
Part No.	Size
13610	1/8"
13620	5/32"
13630	3/16"
13640	7/32"
13650	1/4"
13660	5/16"
13670	3/8"

33850	
Part No.	Size
33860	3mm
33870	4mm
33880	5mm
33890	6mm
33900	7mm
33910	8mm
33920	10mm

42150 42300 HEX KEY SETS

In a Handy Storage Case.

42150 Standard Set includes 12 heat-treated alloy steel hex keys. 42300 Metric Set includes 9 heat-treated alloy hex keys. Also available individually.

42150 Standard Hex Key Set. Skin-packed. Shipping wt. 7 oz.

42300 Metric Hex Key Set. Skin-packed. Shipping wt. 10 oz.

Part No.	Wrench Size
42160	.05"
42170	1/16"
42180	5/64"
42190	3/32"
42200	7/64"
42210	1/8"
42220	9/64"
42230	5/32"
42240	3/16"
42250	7/32"
42260	1/4"
42270	5/16"

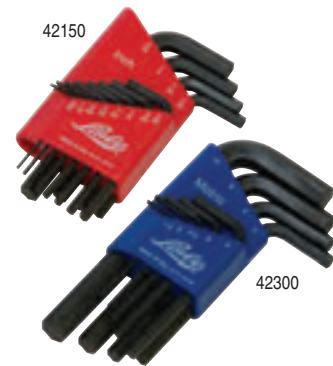

Part No.	Wrench Size
42310	1.5mm
42320	2mm
42330	2.5mm
42340	3mm
42350	4mm
42360	5mm
42370	6mm
42380	8mm
42390	10mm

42500 42650 LONG ARM HEX KEY SETS

In a Handy Storage Case.

Allows for longer reach for deep socket Allen-type screws. Also increases torque. 42500 includes 12 fractional hex keys. 42650 includes 9 metric hex keys. Heat-treated alloy steel. Also available individually.

42500 Standard Long Arm Hex Key Set. Skin-packed. Shipping wt. 10 oz.

42650 Metric Long Arm Hex Key Set. Skin-packed. Shipping wt. 13 oz.

Part No.	Wrench Size
42520	5/16"
42530	1/4"
42540	7/32"
42550	3/16"
42560	5/32"
42570	9/64"
42580	1/8"
42590	7/64"
42600	3/32"
42610	5/64"
42620	1/16"
42630	.05"

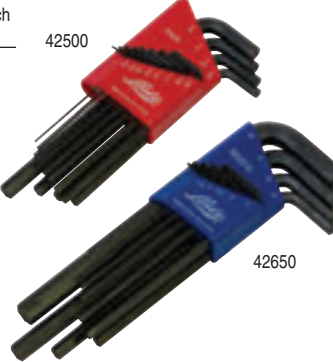

Part No.	Wrench Size
42660	10mm
42670	8mm
42680	6mm
42690	5mm
42700	4mm
42710	3mm
42720	2.5mm
42730	2mm
42740	1.5mm

82400 MORTORQ® SUPER SOCKET SET, 5PC.

For Removing and Installing MORTORQ® Fasteners Found on Chrysler, GM, Jeep and Other Models.

The fasteners are used in a variety of applications including bell housings, interior components, door frames, body components and more. Sockets are made of heat-treated alloy steel. Includes sizes MTS-0, MTS-1, MTS-2, MTS-3 and MTS-4. Use with 3/8" square drive. Includes vinyl holder for storage.

82400 MORTORQ® Super Socket Set, 5pc. Skin packed. Shipping wt. 10 oz.

82410 #0 Socket

82420 #1 Socket

82430 #2 Socket

82440 #3 Socket

82450 #4 Socket



FASTENER

60850 MASTER TRIPLE SQUARE BIT SET

Nine Piece Triple Square (12 point) Bits to Fit 4, 5, 6, 8, 10, 12, 14, 16 and 18mm Sizes.

For head bolts, brake caliper bolts, door handle screws, axle bolts and other applications. The 4 and 5mm bits have 5/16" hex drive. The 6, 8, 10 and 12mm bits have 1/2" hex drive. The 14 and 16mm bits have 5/8" hex drive. The 18mm bit has a 3/4" hex drive. The three largest sizes are designed to work on tamper-proof applications.

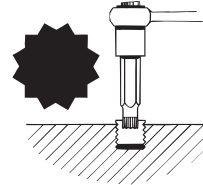

ALL BITS ARE ALSO AVAILABLE INDIVIDUALLY

60850 Master Triple Square Bit Set Skin-packed. Shipping wt. 15 oz.	
60710 4mm Triple Square Bit	60720 5mm Triple Square Bit
60760 6mm Triple Square Bit	60770 8mm Triple Square Bit
60780 10mm Triple Square Bit	60790 12mm Triple Square Bit
60860 14mm Triple Square Bit	60870 16mm Triple Square Bit
60880 18mm Triple Square Bit	

60750 12 POINT BIT SET

Triple Square (12 point) Bits to Fit 6, 8, 10 and 12mm Sizes; all on 1/2" Hex Drives.

Fits some head bolts, retaining bolts, disc brake calipers and other applications.

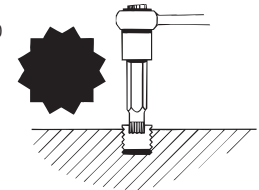

ALL BITS ARE ALSO AVAILABLE INDIVIDUALLY SKIN-PACKED

60750 12 Point Bit Set. Skin-packed. Shipping wt. 10 oz.	
60760 6mm 12 Point Bit	60770 8mm 12 Point Bit
60780 10mm 12 Point Bit	60790 12mm 12 Point Bit

62900 SUPER OUT SET

A SUPER STRONG Extractor Set Made of a Special Hardened, Shock-Resistant Tool Steel.

Works on both left and right hand threads. Super Outs cut their way STRAIGHT into bolts, eliminating wedging or further tightening of frozen bolts and screws. Five extractor sizes extract 1/4" to 1/2" and larger bolts and screws. All bits available individually skin packed.

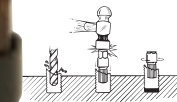

Part No.	Bolt Size	Drive Size
62560	1/4"	1/8"
62570	5/16"	11/64"
62730	3/8"	15/64"
62580	7/16"	9/32"
62590	1/2"	3/8"

62900 Super Out Extractor Set. Skin-packed. Shipping wt. 4 oz.

U.S. Pat No. 6,098,499

61980 STRIPPED SCREW EXTRACTOR SET, 10PC.

Six Lobed Spiral Bits are Designed to Remove Rounded or Stripped Fasteners with Internal Drive Heads.

Ten sizes of extractors fit Torx® and Torx Plus® sizes T-10 to T-55; internal hex sizes 7/64" to 3/8" and 3mm to 10mm. Will also work on other internal drive screw heads. To remove broken bolts, drill a pilot hole for the appropriate size extractor. Choose the extractor that fits snugly in the fastener. Turn counter-clockwise to remove fastener. It may be necessary in some applications to drive the extractor into the fastener with a hammer for maximum torque.



U.S. Pat No. 8,448,547

61980 Stripped Screw Extractor Set, 10pc. Skin Packed. Shipping wt. 9 oz.

62010 #1 Stripped Screw Extractor	62020 #2 Stripped Screw Extractor
62030 #3 Stripped Screw Extractor	62040 #4 Stripped Screw Extractor
62050 #5 Stripped Screw Extractor	62060 #6 Stripped Screw Extractor
62070 #7 Stripped Screw Extractor	62080 #8 Stripped Screw Extractor
62090 #9 Stripped Screw Extractor	62100 #10 Stripped Screw Extractor



EXTRACTOR	TORX®/TORX PLUS®	INTERNAL HEX	DRILL SIZE
#1	T/TP-10	7/64" (3MM)	7/64
#2	T/TP-15	9/64"	9/64
#3	T/TP-20	5/32" (4MM)	5/32
#4	T/TP-25-27		3/16
#5	T/TP-30	3/16"	13/64
#6	T/TP-40	5MM	15/64
#7	T/TP-40	1/4" (6MM)	17/64
#8	T/TP-45	5/16" (8MM)	21/64
#9	T/TP-50	3/8"	3/8
#10	T/TP-55	10MM	29/64

50180 NUT SPLITTER

Tool Removes Stuck Nuts 7/16" up to 3/4".

Drop-forged steel body with heat-treated chisel point. Offset design allows clearance for wrench or socket.

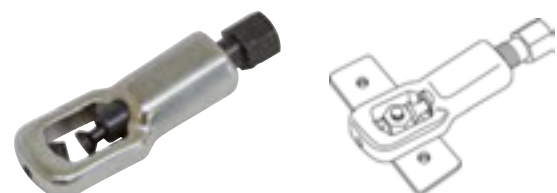

50180 Nut Splitter. Skin packed. Shipping wt. 12 oz.

29200 30200 HAND IMPACT TOOL SETS

Loosens Rusted, Frozen Nuts, Bolts and Screws.
 Unique design delivers over 200 ft. lbs. of "Shock Torque".
 Can be reversed to tighten. Can also be used with impact sockets!

29200 3/8" Impact Tool Set. 3/8" sq. drive with 3/8" drive bit holder; #1, #2, #3, #4 Phillips, and 3/8" straight slot bits. Shipping wt. 2 lbs. 10 oz. NSN 5120-01-072-2956

30200 1/2" Impact Tool Set. 1/2" sq. drive with 1/2" drive bit holder; #1, #2, #3, #4 Phillips, and 3/8" straight slot bits. Shipping wt. 2 lbs. 10 oz. NSN 5120-01-072-2956



30200 IMPACT SET INCLUDES:

Part No.	Tool
30000	1/2" Impact Tool
30150	1/2" Bit Holder
29630	#1 Phillips Bit
30180	#2 Phillips Bit
29550	#3 Phillips Bit
30190	#4 Phillips Bit
30170	3/8" Straight Slot Bit

29200 IMPACT SET INCLUDES:

Part No.	Tool
29000	3/8" Impact Tool
29520	3/8" Bit Holder
29630	#1 Phillips Bit
30180	#2 Phillips Bit
29550	#3 Phillips Bit
30190	#4 Phillips Bit
30170	3/8" Straight Slot Bit

30750 HAND IMPACT TOOL SET

Loosens Rusted or Frozen Screws Quickly...Manually.
 A popular tool also available in a smaller, easy-to-display clam-shell package. Simply strike with a hammer. Each impact turns the bit 20° and develops up to 200 ft-lbs torque to free rusted or frozen screws. Can also be used with 1/2" drive impact sockets. Includes #2, #3, #4 Phillips and 3/8" straight bits with 5/16" hex drive.

30750 Hand Impact Tool Set. Clam Shell. Shipping wt. 2 lbs. 2 oz.

Bits Included:

- 29550 #3 Phillips Bit
- 30170 Straight Slot Bit
- 30180 #2 Phillips Bit
- 30190 #4 Phillips Bit



62140 SEIZED FASTENER REMOVER KIT

For Use with a Pneumatic Impact Tool to Loosen Rusted or Seized Fasteners. Specially Designed Driver Works with the Included Sockets or Bit Holder and 5/16" Hex Impact Bits.

Hex shape of the sockets and flats on the bit holder allow use of a turning wrench while impacting the fastener. A locking pin in the driver keeps the bit holder in place on the square drive for safe operation. The bit holder can be removed from the driver by depressing the pin. Kit includes six sockets, Phillips #1, #2, #3, #4 and a straight slot bit.

62140 Seized Fastener Remover Kit. Blow Molded Case. Shipping wt. 1lb. 14 oz.

29010 #1 Phillips Bit	29020 #2 Phillips Bit	29030 #3 Phillips Bit
29140 #4 Phillips Bit	29190 Straight Slot Bit	60280 Socket #1
60290 Socket #2	60300 Socket #3	60310 Socket #4
60320 Socket #6	60340 Socket #5	60540 Driver
60550 Bit Holder	60600 Bit Set with Holder	



U.S. Pat No. 8,272,299
8,607,672

60530 SMALL FASTENER REMOVER

For Use with a Pneumatic Impact Tool to Loosen Rusted or Seized Fasteners.

A 3/4" open end wrench can be used to turn the bit holder while impacting the fastener. A locking pin in the driver keeps the bit holder in place on the square drive for safe operation. The bit holder can be removed from the driver by depressing the pin. Works faster than hand impact tools. Especially useful for removing brake rotor screws. The tool works with 5/16" hex impact bits. Kit includes Phillips #1, #2, #3, #4 and a straight slot bit.

60530 Small Fastener Remover. Skin Packed. Shipping wt. 13 oz.

29630 #1 Phillips Bit	30180 #2 Phillips Bit	29550 #3 Phillips Bit
30190 #4 Phillips Bit	30170 Straight Slot Bit	60540 Driver
60550 Bit Holder		



19250 STUCK BOLT, NUT, AND STUD REMOVER SET

6 Piece Set Removes Standard and Metric Bolts, Nuts and Studs from 1/4" to 9/16" (6mm to 14mm).

Drive the proper size remover over the bolt head, nut or stud. The remover spline cuts into the bolt head or threads for a sure grip.

19250 Stuck Bolt, Nut, and Stud Remover Set. Clam Shell. Shipping wt. 12 oz.

19260 #1 Remover. Fits 1/4" and 6mm.

19270 #2 Remover. Fits 5/16" and 8mm.

19280 #3 Remover. Fits 3/8" and 10mm.

19290 #4 Remover. Fits 7/16" and 11mm.

19300 #5 Remover. Fits 1/2" and 13mm.

19310 #6 Remover. Fits 9/16" and 14mm.

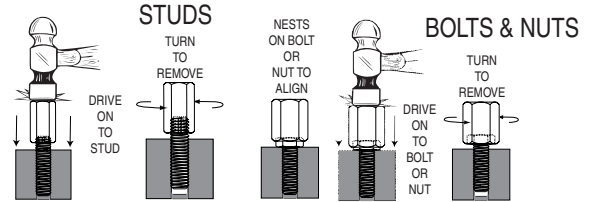

71200 STUD REMOVER

Removes Studs from Engine Blocks, Exhaust Manifolds, Cylinder Heads and Other Applications.

Allows for easy removal of studs. Tool has two holes, 1/2" (14mm) and 3/4" (19mm) for optimum fit, minimizing damage to threads. Range 3/8" (10mm) – 3/4" (19mm). Design allows tool to grip flush with mounting surface of the stud so it can grab studs that are broken off very close to the mounting surface. Use with 1/2" square drive.

71200 Stud Remover. Clam Shell. Shipping wt. 20 oz.



64250 RIGHT ANGLE RATCHETING SCREWDRIVER

Use Where a Screwdriver Won't Fit.

Makes it easy to remove and install molding around fender wells and other tight places. Place handle over the bit and turn. Reverse handle on bit to tighten. Can also be used with 1/4" round shaft screwdriver. Ratcheting action with infinite settings. Includes straight slot and #2 Phillips bit assemblies.

64250 Right Angle Ratcheting Screwdriver. Skin-packed. Shipping wt. 6 oz.

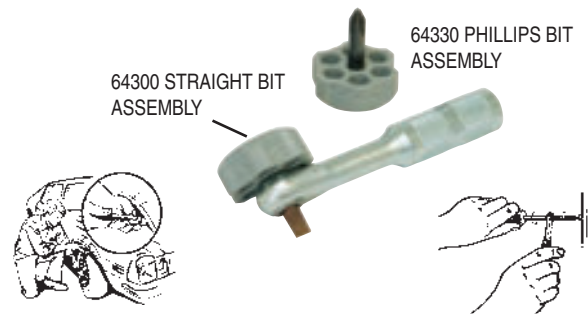

64650 IGNITION MODULE WRENCH FOR FORD

For 7/32" Hex Retaining Bolts on Ford Ignition Module.

May be used with 1/2" wrench.

64650 Ignition Modulator Wrench for Ford. Skin-packed. Shipping wt. 2 oz.

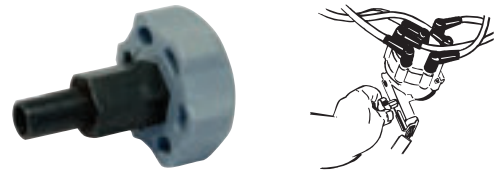

28100 TORQUE ANGLE METER

For All Torque-to-Yield Fastener Applications.

Commonly used for tightening head bolts and other bolts where a torque angle is required. Use with 1/2" drive.

28100 Torque Angle Meter. Skin-packed. Shipping wt. 13 oz.

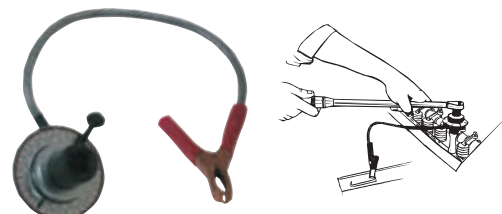

49200 HEAVY DUTY INTERNAL / EXTERNAL SNAP RING PLIERS

Reversible Action for Internal and External Applications.

The heavy duty plier construction and larger tips are designed for larger snap rings. The tool quickly converts from internal to external use by pivoting the handles. Tough tool easily compresses internal rings and expands external rings. Conical tip ends prevent the snap ring from slipping off the tips. Ten tip sets in a handy plastic pouch are included to fit a wide range of snap ring sizes. Tips are easily interchanged by turning a set screw, wrench included.

49200 Heavy Duty Snap Ring Pliers. Skin-packed. Shipping wt. 12 oz.

49460 Replacement Tips

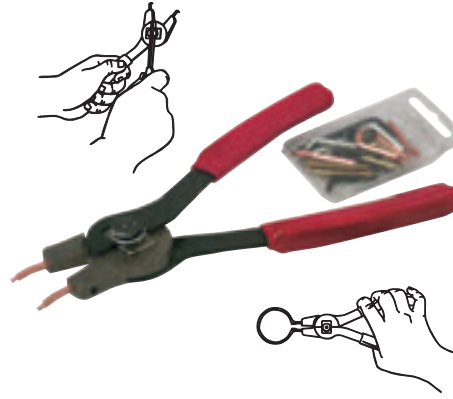

49460 Tip Set
Includes
Two Each of the
Following Sizes:

Diameter	Angle
.060"	75°
.060"	15°
.075"	75°
.075"	15°
.090"	75°
.090"	15°
.108"	75°
.108"	15°
.125"	75°
.125"	15°

46200 SNAP RING PLIERS, SMALL

Reversible Action for Both Internal and External Snap Rings. Smaller Design to Fit Tight Spaces.

The tool quickly converts from internal to external use. Simply pivot each handle to the opposite side to reverse action. Includes four pairs of tips to fit a wide range of snap ring sizes. 45° and 90° tips for hard to reach areas. Conical tip ends prevent the snap ring from slipping off of the tips.

46200 Snap Ring Pliers, Small. Skin packed. Shipping wt. 4 oz.

46250 Replacement Tip Set.



46250 Replacement
Tip Set Includes:

- .045" straight tips
- .060" straight tips
- .045" 45 degree tips
- .035" 90 degree tips



EXTERNAL SNAP RING



INTERNAL SNAP RING

46000 COMBINATION INTERNAL / EXTERNAL SNAP RING PLIERS

A Handy Combination Tool for Internal and External Snap Rings.

Compresses internal rings in one position. Move the quick-change reversing lever to expand external rings. Four sets of tips in a plastic box.

46000 Snap Ring Pliers. Skin-packed. Shipping wt. 7 oz.

46250 Replacement Tip Set



EXPANDS
EXTERNAL RINGS

EASY, QUICK CHANGE
REVERSING LEVER



COMPRESS
INTERNAL RINGS



FASTENER

44900 LOCK RING PLIERS

For Removing and Installing All Types of Lock Rings.

Spreads lock rings commonly found on transmissions, master cylinders, brakes and other applications. Specially designed jaws are knurled on the end to prevent slipping.

44900 Lock Ring Pliers. Skin-packed. Shipping wt. 8 oz.



42400 5 PC. AIR LINE DISCONNECT SET

Disconnects Quick Connect Push-In Connectors Found on Heavy-Duty Truck Air Systems and More.

Disconnects air systems on brakes, suspension, steering, engine, transmission and other auxiliary equipment. Also disconnects other quick connect push-in fittings, including: flow control valves, check valves, shuttle valves, quick exhaust valves and other function control fittings. Smallest size works on automatic adjusting air suspension systems for automobiles. Five popular sizes: 1/8-5/32", 1/4", 3/8", 1/2" and 5/8". Each tool is double-ended for hard-to-reach areas.

42400 5 pc. Air Line Disconnect Set. Skin-packed. Shipping wt. 1 lb.

42100 1/4" Air Line Disconnect

42110 3/8" Air Line Disconnect

42120 1/2" Air Line Disconnect

42130 5/8" Air Line Disconnect

42470 1/8-5/32" Air Line Disconnect

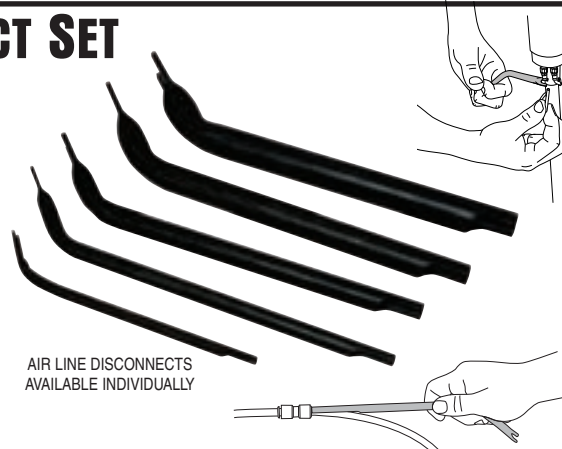

AIR LINE DISCONNECTS
AVAILABLE INDIVIDUALLY

35260 PLASTIC FASTENER REMOVER

Removes Plastic Hold-Down Fasteners.

This tool quickly removes various types of plastic fasteners that hold on weather stripping, radiator shrouds, fender linings, air dams and other plastic or rubber parts. The tool is equipped with a sliding urethane button for use when extra leverage is necessary.

35260 Plastic Fastener Remover. Skin-packed. Shipping wt. 3 oz.

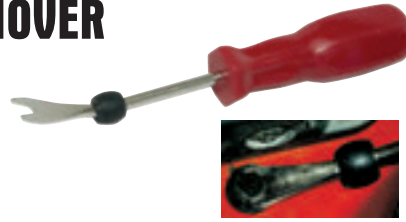

REMOVING PLASTIC RIVET



REMOVING WEATHER STRIPPING

U.S. Pat No. 6,663,082

35400 DOOR UPHOLSTERY REMOVER

For Plastic Fasteners.

Place the tool under the edge of the door panel and insert into fastener as far as possible...then simply pry up. Rugged tool with a large comfortable handle.

35400 Door Upholstery Remover. Skin-packed. Shipping wt. 7 oz.

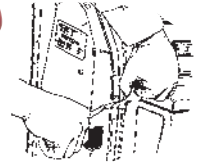

35350 DOOR PANEL REMOVER

Removes Door Panel Fasteners, Even In Tight Spaces.

The bent handle design allows use where space is limited, and provides extra prying force. The unique, square cutout in the tool tip provides a no-slip grip, even on fasteners with small ears.

35350 Door Panel Remover. Skin-packed. Shipping wt. 8 oz.

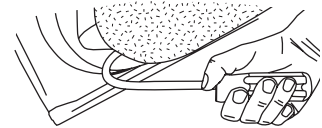
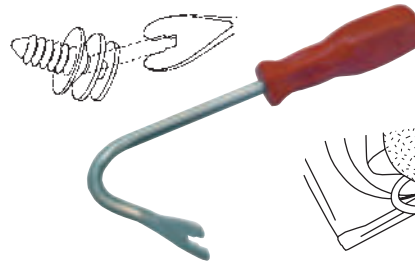

35440 BODY TRIM TOOL SET, 3 PIECE

Clip Remover Helps Remove Door Handle and Window Crank Clips.

Works on GM, Ford and others using common "C" type clip. Upholstery and Panel Removers are designed for plastic fasteners.

35440 Body Trim Tool Set, 3 Piece. Clam Shell. Shipping wt. 1 lb. 4 oz.

35350 Door Panel Remover 35400 Door Upholstery Remover
54960 Window and Door Clip Remover

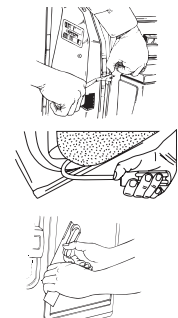

BODY

18600 WINDOW AND DOOR CLIP REMOVER / INSTALLER

Removes and Installs Door Handle and Window Crank Clips.

Works on the common "C" type clip. Really fast and easy. Helps prevent damage to door panel upholstery. Opposite end firmly holds clip for easy installation.

18600 Window and Door Clip Remover / Installer. Skin-packed. Shipping wt. 6 oz.

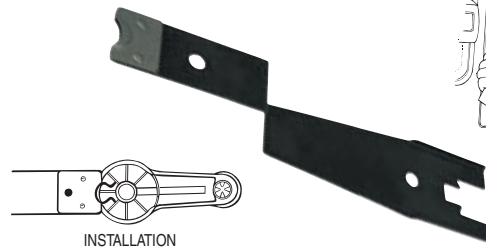

INSTALLATION

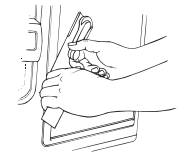

REMOVAL

61400 STRAIGHT HOG RING PLIERS

61410 ANGLED HOG RING PLIERS

Close Hog Ring Fasteners Used on Upholstery.

Steel pliers are durable and easy to use. Spring loaded jaws hold the hog ring. Cushioned grips for comfort. Angled Pliers have a 45° angled head to fit into tight spaces.

61400 Straight Hog Ring Pliers. Skin-packed. Shipping wt. 8 oz.

61410 Angled Hog Ring Pliers. Skin-packed. Shipping wt. 8 oz.

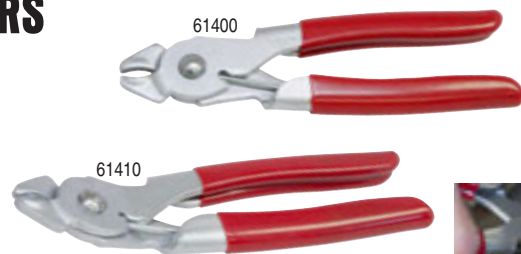

61400

61410



41250 42420 42430 PUSH PIN PLIERS

For Easy Removal of Plastic Push Pin Type Panel Fasteners with Center Pins.

Plier tips are angled 30° - 42420 / 80° - 42430 for use in tight spaces such as wheel wells. Designed to prevent damage to the pin or anchor. Dual durometer grips for comfort.

41250 Push Pin Pliers. Skin packed. Shipping wt. 8 oz.

42420 30° Push Pin Pliers. Skin Pack Card. Shipping wt. 8 oz.

42430 80° Push Pin Pliers. Skin Pack Card. Shipping wt. 8 oz.

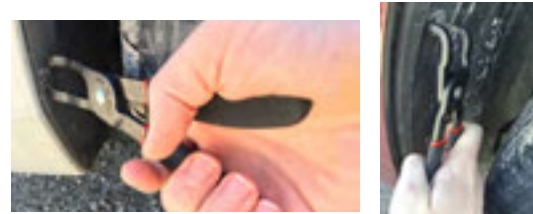

BODY

41080 41090 TRIM CLIP PLIERS

Easily Removes Trim Panel Fasteners.

Specially designed double tapered tips slide under the clip and grip the side of the clip, helping prevent damage. Tips are angled 45° & 90° providing more leverage for easier clip removal, even in very tight spots. Dual durometer cushioned grips for comfort.

41080 45° Trim Clip Pliers. Skin Pack Card. Shipping wt. 7 oz.

41090 90° Trim Clip Pliers. Skin Pack Card. Shipping wt. 7 oz.



42480 PANEL CLIP PLIERS

Spring Loaded Pliers Provides Extra Leverage to Remove Door Clips Without Damage.

Ergonomic spring loaded handles are rotated 90° to provide leverage needed to easily remove push in fasteners. The tapered forked end makes getting under the clips easier and helps prevent damage to the clips or door panel. Works on a wide range of push in clip sizes.

42480 Panel Clip Pliers. Skin Pack Card. Shipping wt. 7 oz.



59250 MOLDING REMOVER SET

Quickly Removes Body Moldings.

Two spring steel blades, 2" and 3-1/2", are included for all sizes of body moldings. Use with the conventional handle, or for tough jobs, attach the pneumatic driver for use with an air hammer set at 40 psi or less. The replaceable blades flex to follow the body contour.

59250 Molding Remover Set. Skin-packed. Shipping wt. 9 oz.

59300 3-1/2" Blade

59310 2" Blade

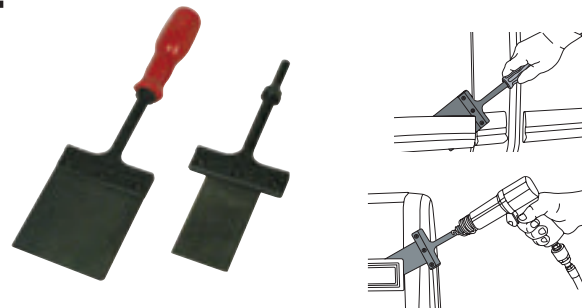

47000 WINDSHIELD LOCKING STRIP TOOL

Two Double-Ended Tips to Fit Most All Applications.

Unique design allows tip to swivel 90° in either direction to work where others won't. Just select the tip with opening that most closely fits locking strip, and then feed locking strip into eyelet.

47000 Windshield Locking Strip Tool. Skin-packed. Shipping wt. 7 oz.

TIP SWIVELS 90° IN EITHER DIRECTION

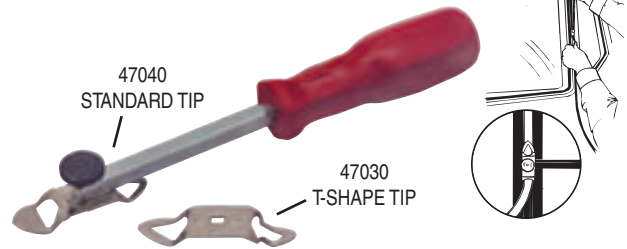

48600 OFFSET WINDSHIELD LOCKING STRIP TOOL

Offset Handle for Extra Clearance and Two Double Ended Tips to Fit Most Applications.

Offset design provides installers extra clearance to work on windshields or other glass on semis, skid loaders and agricultural applications with locking strips. Tip swivels 90° in either direction. Select the tip with opening that most closely fits locking strip.

48600 Offset Windshield Locking Strip Tool. Skin Pack Card. Shipping wt. 6 oz.

47030 T-Shape Tip

47040 Standard Tip



68300 TRIM REMOVAL SET, 11 PC.

Designed to Remove Door Panels, Fascia and Trim Stripes, Dashboards, Interior Panels and Trim, Window Moldings, etc. in Vehicles.

Specially designed deep V-notch design for better engagement of small fasteners. Tools have multiple tip angles and sizes to work on many different applications. Made from impact resistant plastic for leverage, but will not damage vehicle surfaces. Includes a handy pouch that can be folded or hung for easy storage and access.

68300 Trim Removal Set, 11 pc. Box with Color Label. Shipping wt. 1 lb. 7 oz.

68310 Wide-Type Remover	68320 Pull-Type Remover
68330 Handy Remover	68340 Narrow-Type Remover
68350 Upholstery Clip Remover	68360 Angled Clip Panel Rmvr
68370 Fork Tip Flat Clip Rmvr	68380 Clip Panel Remover
68390 Sharp Tip Flat Clip Rmvr	68400 Panel Remover
68410 Blunt Tip Flat Clip Rmvr	68420 Black Pouch for 68300

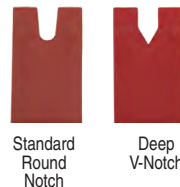
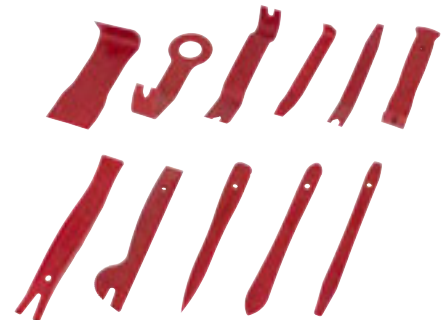

81200 PLASTIC CHISEL SCRAPER SET

Set of Three Plastic Chisels for Removing Emblems and Adhesive Backed Trim Without Damage.

The one piece high-impact plastic chisels can also be used to remove stick-on weights from aluminum wheels as well as gaskets from aluminum, without marring. The plastic blades can be resharpened as needed. The set includes 3/4", 1" and 1-1/2" blade widths. Hand guard and hang hole are built into each flexible scraper.

81200 Plastic Chisel Scraper Set. Skin-packed. Shipping wt. 13 oz.

81210 3/4" Plastic Chisel Scraper	81220 1" Plastic Chisel Scraper
81230 1-1/2" Plastic Chisel Scraper	

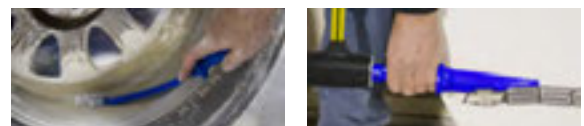
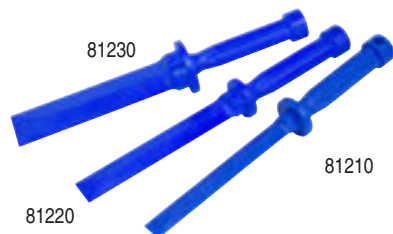

34920 DOOR LATCH RELEASE TOOL

This Tool is Used to Release the Cable from the Handle Assembly So the Door Panel Can Be Removed.

The tool is designed to work on 2007-2013 Chevy and GMC pickups, Suburban, Tahoe, Avalanche and Yukon vehicles. This tool may also work on other applications.

34920 Door Latch Release Tool. Skin packed. Shipping wt. 2 oz.

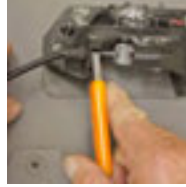

YouTube

32860 DOOR HANDLE SPRING RETAINER TOOL FOR GM

Allows Outer Door Handle Replacement Without Removal of the Interior Door Panel on GM Vehicles.

Designed to prevent damage to the door components and finish. Works on 2014 and newer Yukon, Tahoe, Suburban, Silverado, Sierra, Impala and Escalade.

32860 Door Handle Spring Retainer Tool for GM. Skin Pack Card. Shipping wt. 2 oz.



YouTube

35150 WINDOW BELT MOLDING REMOVER

Quickly Removes All Window Belt Moldings.

Slide the powder-coated tool downward between the window exterior and the door. The channel side of the tool should face the door. When the tool channel is below the belt molding, push or pull the tool upward. The tool quickly removes the belt molding without damage to the window or the molding. Fits most domestic and import vehicles.

35150 Window Belt Molding Remover. Skin-packed. Shipping wt. 5 oz.



U.S. Pat No. 7,147,209

35200 WINDSHIELD MOLDING / DOOR HANDLE CLIP PLIERS

For removing most windshield molding clips and door handle clips.

Releases clips to remove chrome molding on most windshields and rear glass. Offset handle permits easy access to molding clips. Slips under door handle without damage to panel material.

35200 Windshield Molding/Door Handle Clip Pliers. Skin-packed. Ship wt. 5 oz.

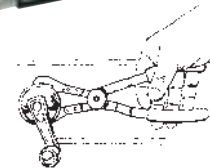
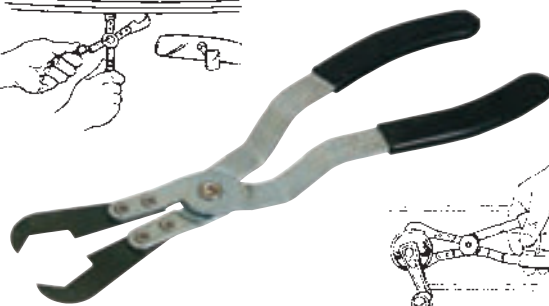
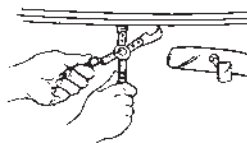

65750 WINDSHIELD WIPER ARM REMOVER

Makes Wiper Arm Removal and Replacement an Easy Job.

Easily removes wiper arms without damage to car finish.

65750 Windshield Wiper Arm Remover. Skin-packed. Shipping wt. 4 oz.

NSN 5120-00-419-5693

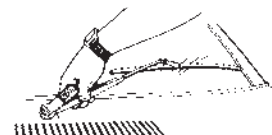

14540 HEADLIGHT ADJUSTING RATCHET FOR FORD

Works on Ford Aerodynamic Headlights with Rear Mounted Adjusters.

Tool is used to adjust aerodynamic headlights with rear mounted adjusters on Ford vehicles. These adjusters are not easily accessible and require this tool for adjusting. The extra long handle allows easy access to hard-to-reach spaces. Tool has a 4mm hex with a roller clutch for infinite settings.

14540 Headlight Adjusting Ratchet for Ford. Skin-packed. Shipping wt. 6 oz.

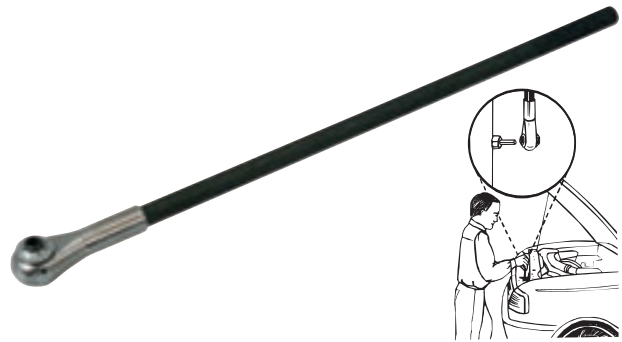

29650 ANTENNA NUT SOCKET SET

For Removing or Replacing Antennas.

Four double-ended sockets fit eight common domestic & import antenna nuts. The smaller three sockets are 7/8" hex & the larger socket is 1-1/4" hex. Sockets are made of heat-treated alloy steel for strength. Complete applications are listed on the card. Sockets are also available individually.

29650 Antenna Nut Socket Set. Skin-packed. Shipping wt. 12 oz.

29810 Antenna Nut Socket #1

29820 Antenna Nut Socket #2

29830 Antenna Nut Socket #3

29600 Antenna Nut Socket #4

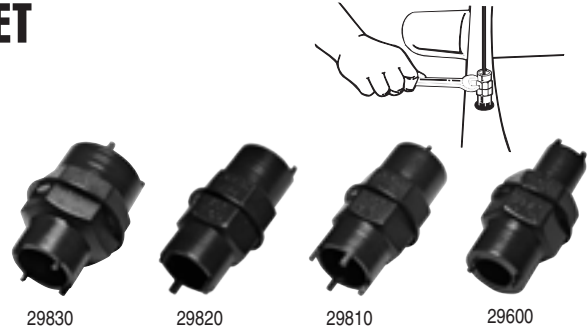

63900 WINDOW HOLDER

Holds Door Glass While Working on Window Regulator.

Works on all cars and trucks with a top door frame. Simply loop cable over door frame and attach suction cups to each side of glass. Window glass is then securely held above the door while work is performed.

63900 Window Holder. Clam Shell Package. Shipping wt. 5 oz.



65800 DOOR ADJUSTER

Adjusts Door Hinges on Most All Cars and Light Trucks.

Will adjust doors with either bolted or welded hinges. Simply slide pin end of tool into door latch and close door until tool engages door striker. Now raise or lower tool handle to align door. Comes with two-headed pin adapter for both large and small latches. Specially designed handle for optimum leverage, makes adjustment fast and easy.

65800 Door Adjuster. Boxed. Shipping wt. 5 lbs. 2 oz.

65810 Two-Headed Pin Adapter.

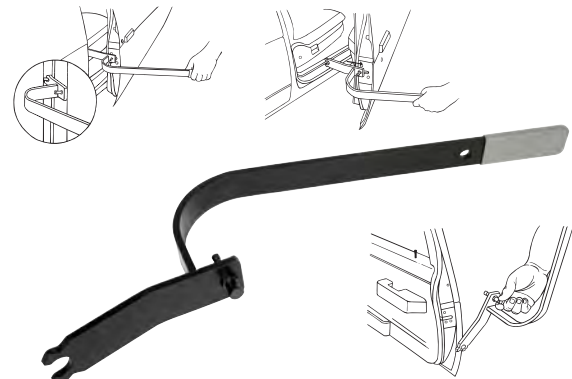

51900 SPOT WELD CHISEL

Separates Spot Welded Panels.

Use to separate panels after the spot weld has been drilled out. Drive the blade with a hammer from the end or the side through the panel seam. Panels are separated without damage. The blade is sharpened on three sides, and offset for clearance. NOTE: The sharpened edges will wear with use. Resharpen on a grinding wheel.

51900 Spot Weld Chisel. Skin-packed. Shipping wt. 8 oz.

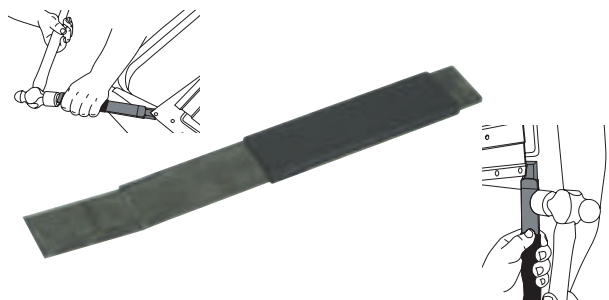

57850 BATTERY CARRIER

Lift and Carry Batteries Safely.

Sturdy steel jaws securely hold batteries. Spring-action handle turns lifting power into battery gripping pressure. Form-fitting handle provides a solid gripping surface for your hand. Carrier works on nearly all batteries, from motorcycles to boats. Saw-tooth jaw tips provide no-slip battery gripping power. Carrier grips the battery just below the top lip for good balance. A heavy-duty tool that is built to last.

57850 Battery Carrier. Hang Card. Shipping wt. 1 lb. 11 oz.

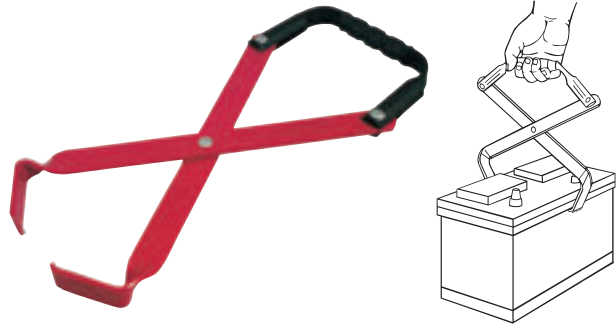

54150 BATTERY TERMINAL & WIPER ARM PULLER

Removes Battery Terminals and Bolted on Wiper Arms.

A dual-purpose puller. Easily removes stuck battery terminals. Tighten knurled cone to force jaws under the cable clamp. Turn center screw to lift clamp off terminal. Also removes bolted on windshield wiper arms that fit over a tapered spline. The puller screw pad is designed to fit the top of the spline post for easy pulling.

54150 Battery Terminal & Wiper Arm Puller. Skin-packed. Shipping wt. 10 oz.

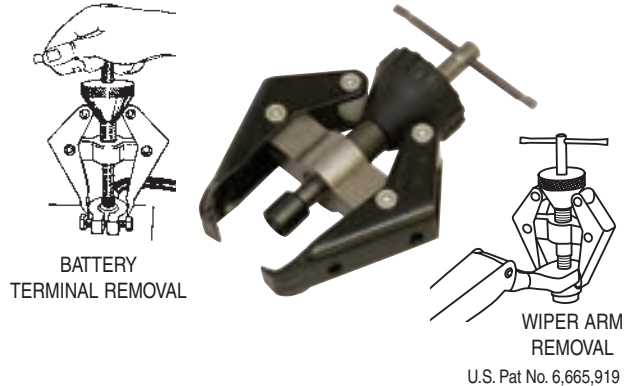

11120 BATTERY BRUSH

Cleans Dirt and Corrosion from Battery Terminals and Cable Clamps.

The external brush cleans cable clamps and internal brush cleans terminal posts. Case is made of high impact plastic that will not weaken in cleaning solutions.

11120 Battery Brush. Skin-packed. Shipping wt. 3 oz.



55410 BATTERY CLAMP SPREADER & CLEANER

One Tool for Two Jobs.

Dual-use pliers spread battery post clamp and tapered, ribbed tips remove corrosion and build-up from inside the clamp.

55410 Battery Clamp Spreader & Cleaner. Skin-packed. Shipping wt. 11 oz.

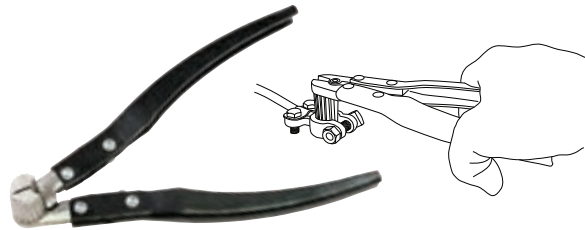

11400 SIDE TERMINAL BATTERY CLEANER

A Special Tool for a Special Job.

"Coil Spring" cutters polish the battery contact while stainless steel brushes clean the cable terminals.

11400 Side Terminal Battery Cleaner. Skin-packed. Shipping wt. 2 oz.



11550 3 WAY BATTERY TOOL

Cleans and Removes Corrosion on Battery Posts and Terminals.

Tapered reamer cleans and shapes terminal clamps. Positive and negative post cleaners are sized to fit battery posts.

11550 3 Way Battery Tool. Skin packed. Shipping wt. 5 oz.



71750 LED QUICK CHANGE TERMINAL TOOL SET

Lights the Work Area and Removes Wires from Terminals without Damage.

The lighted handle illuminates electrical connectors. Includes 24 quick-connect terminal disconnect tools, a sheathing ripper and a terminal pin repair tool. Compact handle uses three LR626 batteries, which are provided. A handy application cross-reference is printed in the lid of the blow molded case.



71750 LED Quick Change Terminal Tool Set. Molded Case. Shipping wt. 1 lb. 3 oz.

71770 Tube	71780 Square Blade
71790 Flat Blade	71800 Flat Blade
71810 Spring Loaded Tube	71820 Tube
71830 Tube	71840 Tube
71850 Flat Twin Blade	71860 Flat Twin Blade
71870 Round Blade	71880 Narrow Blade
71890 Knife Blade	71900 Sheathing Ripper Tool
71910 Flat Blade	71920 Flat Blade
71930 Flat Blade	71940 Flat Blade
71950 Single Face Blade Tool	71960 Dual Face Blade Tool
71970 Single Face Blade Tool	71980 Ladder Blade Tool
71990 Knife Blade Tool	72000 Knife Blade Tool
72010 Repair Tool	72020 Square Blade

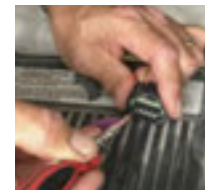

57750 WIRE TERMINAL TOOL KIT

Set of Three Terminal Tools and Handle for Removing Wires from Terminals Without Damage.

Terminal tools work on conventional terminals as well as Pack-Con and Weather-Pack terminals found on many GM vehicles. Blue terminal tool fits many Ford applications. The handle slips over the probes to protect the technician's hand as well as provide extra leverage. All terminal tools are available individually skin-packed.

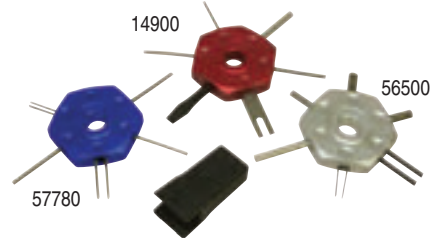

57750 Wire Terminal Tool Kit. Molded Case. Shipping wt. 12 oz.

14900 Terminal Tool for GM	56500 Terminal Tool
57780 Terminal Tool for Ford	57790 Handle



14900 56500 57780 WIRE TERMINAL TOOLS

Eliminate Damaged Wires and Terminals.

Lisle Wire Terminal Tools are designed to remove wires from terminals without damage to either. 56500 prongs depress the "barbs" on conventional terminals. 14900 is designed for Pack-Con and Weather-Pack terminals on GM C3 Systems. Tool can also retrieve trouble codes from engine computer on late model GM vehicles. 57780 fits many Ford applications.

14900 Wire Terminal Tool. Skin-packed. Shipping wt. 2 oz.
56500 Wire Terminal Tool. Skin-packed. Shipping wt. 2 oz.
57780 Wire Terminal Tool. Skin-packed. Shipping wt. 2 oz.

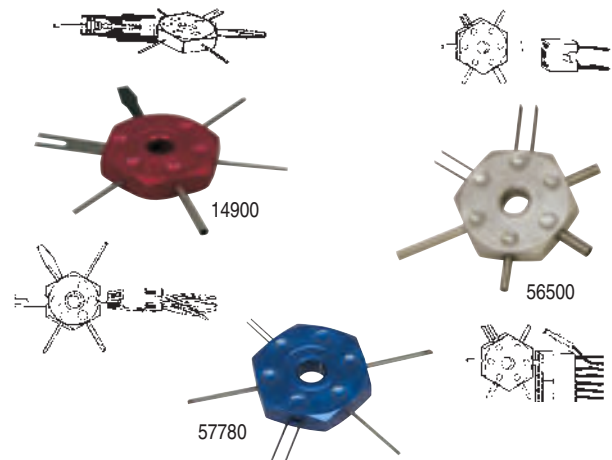

69300 MASTER RELAY AND FUSED CIRCUIT TEST KIT

Test Live Circuits from the Relay or Fuse Box.
Extend the Capability of Your Digital Multimeter.

Includes eight jumpers to fit most popular relays. The jumpers have tabs for clamping and flat pads to place test leads on. Includes Test Lead Kit (see 69250 below) for easily and securely connecting Relay Test Jumpers to a multimeter. Terminal Leads with switch, fuse and power options provide easy access to check current or voltage on many fuses and relays used on vehicles today. Also allows testing of relay configurations not covered by our eight Relay Test Jumpers, Like Volkswagen, BMW and other European vehicles. Relay Puller Pliers easily remove electrical relays without damage to the relay or electrical box. Works without piercing wires.

69300 Master Relay and Fused Circuit Test Kit. Molded Case. Shipping wt. 2 lbs. 2 oz.

46950 Relay Puller Pliers 56820 Yellow Jumper 56830 Red Jumper

56840 Blue Jumper 56850 Green Jumper 60620 Orange Jumper

60630 White Jumper 60640 Purple Jumper 60650 Grey Jumper

69210 Orange Banana Plug Adapter (2) 69220 Terminal to Blue Plug

69230 Terminal to Yellow Plug 69240 Y Terminal to Green Plug

69260 On/Off Switch with 4mm Stackable Banana Plugs

69270 4mm Female Banana to Alligator Clamp - 4'

69280 Red 4mm Banana to 1/4" Female Terminal

69290 Green 4mm Banana to 1/4" Male Spade

69310 Yellow 4mm Banana to 2.75mm Male Spade

69320 Blue 4mm Banana to 7.75mm Male Spade

69330 Black 4mm Banana to Stripped Wire End

69340 4mm Banana Males with Inline ATO Fuse Holder

69350 4mm Female to 4mm Male Extension - 3-1/2'



YouTube

69250 TERMINAL LEADS WITH POWER/SWITCH/FUSE

Provides Easy Access to Check Current or Voltage on Nearly All of the Fuses and Relays Used on Vehicles Today.

- Terminal leads with switch/fuse/power provide several ways to check circuits from the fuse or relay box.
- Different sized ends on the wires give flexibility to plug directly in the relay base or to fit other relay sizes not covered by the relay test jumpers (like VW & BMW).
- Five wire sets (pairs) fit many vehicle fuses including: Female-Pal, JK, LJK, Male-L-mini, Mini ATO and Maxi.
- Use the on/off switch to control a circuit. Test before or after the switch by using the stacking Banana plugs.
- Power lead with alligator clip can apply external 12v power to only the circuit that is being worked on.
- Two 3.5 foot extension lead wires can be used if you are controlling a circuit while the vehicle is on a hoist.
- The in-line fuse holder (common ATO fuse style) protects the circuit and multimeter during testing.
- Allows testing without piercing wires.
- Add to 60660 to make the 69300.

69250 Terminal Leads with Power/Switch/Fuse. Bagged. Shipping wt. 13 oz

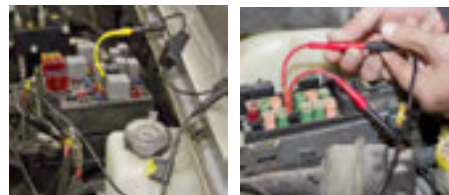

YouTube

46950 RELAY PULLER PLIERS

Pliers for Removing Electrical Relays on Most Domestic and Import Vehicles.

Offset handle and thin tips allow access to relays in confined areas. Specially designed tips are angled to fit slots or edge of relay cover. This allows relay to pop free from socket with less chance of damaging the relay. Also works on many heavy-duty and industrial applications.

46950 Relay Puller Pliers. Skin-packed. Shipping wt. 5 oz.



U.S. Pat No. D596,910

60660 DELUXE RELAY TEST KIT

Includes 8 Jumpers to Fit Most Popular Relays.
Also Includes Test Lead Kit and Relay Puller Pliers.

Jumpers have tabs for clamping and flat pads to place test leads on. No need to pierce wires or connect multiple jumper wires. Also includes Test Lead Kit for easily and securely connecting Relay Test Jumpers to a multimeter. Jumper wire may be used between common and open to close the relay circuit for testing and has a test port to easily check voltage. Also provides access for a clamp-on amp meter. Relay Puller Pliers easily remove electrical relays without damage to the relay or electrical box.

60660 Deluxe Relay Test Kit. Molded Case. Shipping wt. 1 lbs. 8 oz.

46950 Relay Puller Pliers	56820 Yellow Jumper	56830 Red Jumper
56840 Blue Jumper	56850 Green Jumper	60620 Orange Jumper
60630 White Jumper	60640 Purple Jumper	60650 Grey Jumper
69210 Orange Banana Plug Adapter (2)	69220 Terminal to Blue Plug	
69230 Terminal to Yellow Plug	69240 Y Terminal to Green Plug	

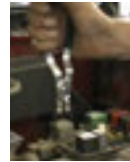

56810 RELAY TEST JUMPER KIT

Set of Four Relay Test Jumpers Make Testing Relays or Live Circuits Quick and Easy.

Set includes four jumpers to fit the most popular size relays on domestic and import vehicles. Simply remove relay to be tested, insert correct jumper and insert relay into jumper. When using green four pin jumper be careful to align pins on jumper and relay correctly. No need to pierce wires or connect multiple jumper wires. Jumpers have tabs for clamping and flat pads to place test leads on.

56810 Relay Test Jumper Kit. Molded Case. Shipping wt. 9 oz.

56820 Yellow Jumper	56830 Red Jumper
56840 Blue Jumper	56850 Green Jumper



60610 RELAY TEST JUMPER KIT II

Set Makes Testing Relays or Live Circuits Quick and Easy on Additional Applications.

Set includes four jumpers to fit many popular relays on Honda, Hyundai, Mitsubishi, Nissan, Toyota, newer Ford and GM mini micro relays as well as International trucks. Simply remove relay to be tested, insert correct jumper and insert relay into jumper. When using grey four pin jumper be careful to align pins on jumper and relay correctly. No need to pierce wires or connect multiple jumper wires. Jumpers have tabs for clamping and flat pads to place test leads on.

60610 Relay Test Jumper Kit II. Molded Case. Shipping wt. 9 oz.

60620 Orange Jumper	60630 White Jumper
60640 Purple Jumper	60650 Grey Jumper



69200 TEST LEAD KIT FOR RELAY TEST JUMPERS

Use with 56810 or 60610 to Easily and Securely Connect Relay Test Jumper to a Multimeter.

Can also use banana plug to pin probe adapter for use with pin probes. Kit contains two terminal to banana tip wires, two pin tip to banana plug adapters and one terminal to banana tip wire with jumper wire. Jumper wire may be used between common and open to close the relay circuit for testing and has a test port to easily check voltage. Also provides access for a clamp-on amp meter.

69200 Test Lead Kit for Relay Test Jumpers. Bagged. Shipping wt. 2 oz.

69210 Orange Banana Plug Adapter (2)	69220 Terminal to Blue Plug
69230 Terminal to Yellow Plug	69240 Y Terminal to Green Plug



82650 MULTIMETER ACCESSORY KIT

Extend Multimeter Capabilities.

Interchangeable probes for a wide range of testing possibilities. Compatible with most multimeters and scopes with standard 4mm connectors. Kit includes 43" long 4mm banana test leads with straight and 90° connections, test probes, long back probes, safety test probes, crocodile clips, female-to-female adaptors, male-to-female adaptors, small alligator clip with male banana and slotted ring adapters. Includes roll-up storage pouch to keep leads and adapters organized.

82650 Multimeter Accessory Kit. Bag with Hang Card. Shipping wt. 12 oz.

64790 Small Gator Male, Black 82670 Long Probe .040, Black

82680 Long Probe .040, Red 82690 Test Probe 2mm, Black

82700 Test Probe 2mm, Red 82710 Crocodile Clip, Black

82720 Crocodile Clip, Red 82730 F-F Connector, Black

82740 F-F Connector, Red 82750 Forked Connector, Black

82760 Forked Connector, Red 82770 M-F Connector, Black

82780 M-F Connector, Red 82790 Pierce Probe 6", Black

82800 Pierce Probe 6", Red 82810 Test Lead 43", Black

82820 Test Lead 43", Red 82850 Small Gator Male, Red

82860 Roll-up Pouch, Black/Clr

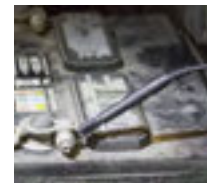

82660 ALLIGATOR EXTENSION TEST CLIP SET

A Handy Set of 6" Insulated Alligator Clips.

Connects to standard 4mm banana test leads for hard-to-reach areas such as under the dash. Strong spring action keeps jaws in contact with the test point. The clip is insulated to help prevent unintentional contact.

82660 Alligator Clip 6" 2pc Set. Bag with Hang Card. Shipping wt. 3 oz.



64970 PARASITIC DRAIN TESTER

Provides an Easy Way to Connect a Multimeter to the Vehicle Electrical System to Diagnose Hidden Battery Drain.

Replaceable in-line fuses protect both the meter and tester in the event a high current source on the vehicle is left on. The multimeter is bypassed with the switch during connection in case of a power surge. The tester and meter can remain connected until other computer systems shut down, isolating the drain. As a convenience, stacking banana connectors are used on the tester. This allows voltage to be measured on various locations on the vehicle during the drain test using standard test leads.

64970 Parasitic Drain Tester. Hang Card. Shipping wt. 4 oz.



64750 11 PC. BACK PROBE KIT 64900 17 PC. BACK PROBE KIT

Straight and Angled Back Probe Pins with Standard Banana Plug Connections.

Straight, 45°, and 90° back probe pins with 4mm standard female banana plug connectors. Angled probes for accessing hard-to-reach connectors. No need to disconnect the terminal and connector. Alligator clips with 4mm male banana connectors provide a connection to multimeter probes. The probes are fully insulated, providing added protection. 64750 contains .027 diameter pins. 64900 adds six .040 diameter pins. For use up to 30 volts.

64750 11 pc. Back Probe Kit. Clam Shell. Shipping wt. 2 oz.

64900 17 pc. Back Probe Kit. Clam Shell. Shipping wt. 3 oz.

64760 .027 Straight Red Probe	64770 .027 Straight Green Probe
64780 .027 Straight Yellow Probe	64790 Male 4mm Banana Alligator Clip (2)
64800 .040 Straight Blue Probe	64810 .040 Straight Black Probe
64820 .027 45° Red Probe	64830 .027 45° Green Probe
64840 .027 45° Yellow Probe	64850 .040 45° Blue Probe
64860 .040 45° Black Probe	64870 .027 90° Red Probe
64880 .027 90° Green Probe	64890 .027 90° Yellow Probe
64910 .040 90° Blue Probe	64920 .040 90° Black Probe

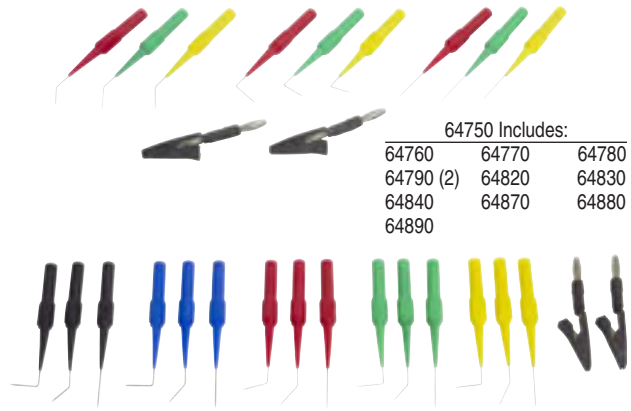

64750 Includes:

64760	64770	64780
64790 (2)	64820	64830
64840	64870	64880
64890		

64900 Includes:

64760	64770	64780	64790 (2)
64800	64810	64820	64830
64840	64850	64860	64870
64880	64890	64910	64920



YouTube

65150 FLEXIBLE BACK PROBES

Flexible Silicone Probe Bends up to 180° for Hard-to-Reach Areas.

Great for checking harness connectors and sensor wiring. No need to disconnect the terminal and connector. The probes are fully insulated which provides added protection. With standard 4mm female banana plug connections. For use up to 30 volts. Wire probe is .038" diameter.

65150 Flexible Back Probes. Clam shell. Shipping wt. 2 oz.

65130 Flexible Back Probe, Red (x2)

65140 Flexible Back Probe, Black (x2)



69600 TEST PROBE KIT

For Easy and Reliable Testing with Multimeters and Circuit Testers.

Includes adapter to securely connect digital circuit tester to 4mm female banana leads and probes. Also seven pairs of male and female spades to 4mm female banana test leads. A long straight back probe and piercing back probe. Spooned probe and crocodile clip.

69600 Test Probe Kit. Box with Color Label. Shipping wt. 8 oz.

69410 6.3mm Male Spade, Red	69420 6.3mm Fem Spade, Red
69430 1.5mm Male Spade, Green	69440 1.5mm Fem Spade, Green
69450 1.5mm Male Round Spade, White	69460 1.5mm Fem Round Spade, White
69470 2.5mm Male Spade, Blue	69480 2.5mm Fem Spade, Blue
69490 2.8mm Male Spade, Black	69500 2.8mm Fem Spade, Black
69510 1mm Male Spade, Gray	69520 1mm Fem Spade, Gray
69530 4.8mm Male Spade, Yellow	69540 4.8mm Fem Spade, Yellow
69550 Flexible Spooned Probe	69560 4mm Probe Adapter
69570 4mm Piercing Back Probe	82680 Long Probe .040, Red
82720 Crocodile Clip, Red	

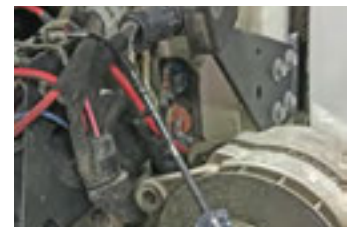

55000 MAGNETIC SOLDERING CLAMP

Offers an Extra Pair of Hands When Soldering.

Alligator clamps firmly hold wire and small parts when soldering. Flexible design allows different ways to attach and hold wire. Clips and base are magnetic and can be attached to any ferrous surface. Magnetic arms can be removed and used without the base. Base is also hex shaped and can fit in a vise when needed.

55000 Magnetic Soldering Clamp. Skin-packed. Shipping wt. 3 oz.

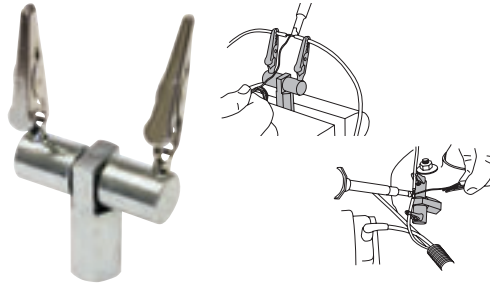

U.S. Pat No. 7,618,029

13120 ELECTRICAL CONNECTOR SEPARATOR

Quickly Disconnects Electrical Connectors Without Damage.

Engage the tool tip behind the connector clip. Push or pull to disconnect. The tool is double-ended to fit different access angles. Works on Weather Pack and other automotive electrical connectors.

13120 Electrical Connector Separator. Skin-packed. Shipping wt. 3 oz.

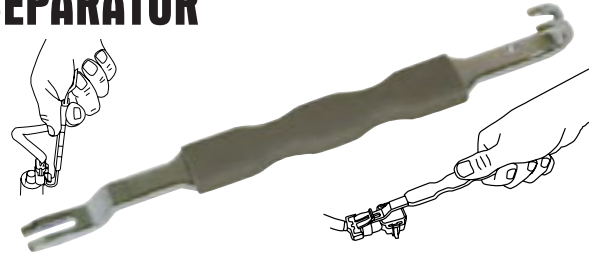

32150 POWER / GROUND OUTLET

Provides a Convenient Electrical Ground and Power Source from the Vehicle.

Plug the tool into the cigarette lighter or power accessory receptacle. You now have a ground and power source on the dash. The plug light will come on to signal the plug is properly connected and both power and ground are available at the posts. For power, connect to the positive (+) terminal. For electrical ground, attach ground wire from the instrument to be grounded to the negative (-) terminal.

32150 Power/Ground Outlet. Skin-packed. Shipping wt. 3 oz.

26270 Replacement Bulb

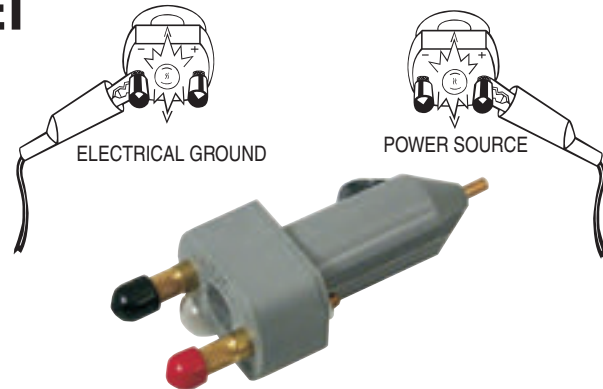

U.S. Pat No. 6,198,272

61030 WIRE INSERTION TOOL SET

Includes 1/4" O.D. and 3/8" O.D. Wire Insertion Tools for Use When Installing Wires for Audio Electronics, Aftermarket Lighting, Alarm Systems and Much More.

With a sharp point on the end and palm size handle, these tools provide extra leverage to pierce through firewalls, rubber grommets and panels. The 10-1/2" steel tube provides easy access to feed wires through the firewall. Tools are available individually.

61030 Wire Insertion Tool Set. Skin packed. Shipping wt. 10 oz.

60950 1/4" Wire Insertion Tool

60960 3/8" Wire Insertion Tool

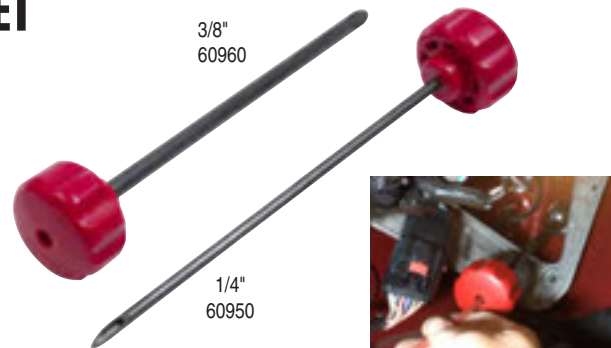

68220 SELF-ADJUSTING WIRE STRIPPER

Automatically Adjusts to Strip Insulation from 10 to 24 Gauge Wire.

Crimps insulated and non-insulated terminals from 10 to 22 gauge and 7 to 8mm ignition terminals with a size key marked on the tool. Built in wire cutter and gripper force adjustment knob. Comfortable handles and steel construction for durability.

68220 Self-Adjust Wire Stripper. Skin packed. Shipping wt. 6 oz.



68250 68280 COMPACT MULTI-FUNCTION WIRE STRIPPER 14-24 & 8-14 GAUGE

Cuts and Strips Insulation from 14 to 24 and 8 to 14 Gauge Wires.

68250 Crimps 14 to 24 gauge and 68280 Crimps 8-14 gauge insulated and non-insulated terminals. The pliers end grabs wire for twisting and holding. A convenient wire gauge key is marked on the tool.

68250 Multi Wire Stripper 14-24. Skin packed. Shipping wt. 6 oz.

68280 Multi Wire Stripper 8-14. Skin packed. Shipping wt. 6 oz.



27170 HEAT SHRINK TUBING ASSORTMENT

RoHS Compliant, Polyolefin Heat Shrink Tubing for Insulating and Protecting Soldered Connections and Connectors.

Includes 160 4" long tubes with six diameters in various colors. Also works for marking and bundling wires. Tubing is halogen free and UL & CSA certified at 600V@125°C. Shrinks at 194° - 248°F (90° - 125°C) with a radial shrink ratio of 2:1.

27170 Heat Shrink Tubing Assortment. Plastic Case with Label. Shipping wt. 6 oz.

27180 Heat Shrink Tube 1/16" 60 Pcs.

27190 Heat Shrink Tube 3/32" 35 Pcs.

27210 Heat Shrink Tube 1/8" 25 Pcs.

27220 Heat Shrink Tube 3/16" 20 Pcs.

27230 Heat Shrink Tube 1/4" 10 Pcs.

27240 Heat Shrink Tube 3/8" 10 Pcs.

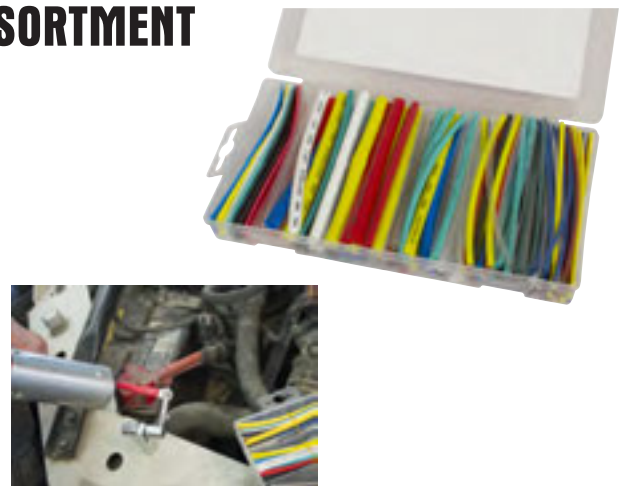

27100 ADHESIVE HEAT SHRINK TUBING ASSORTMENT

Adhesive Coating Inside Tubing Provides Water-Resistant Seal for Insulating and Protecting Soldered Connections and Connectors.

ROHS compliant, Polyolefin heat shrink tubing. Includes 60 4" long tubes with five diameters in various colors. Also works for marking and bundling wires. Tubing is halogen free and UL & CSA certified at 600v@125°C. Shrinks at 194° - 248°F (90° - 125°C) with a radial shrink ratio of 3:1.

27100 Adhesive Heat Shrink Tubing Assortment. Plastic Case. Shipping wt. 6 oz.

27270 Heat Shrink Tube 1/8" 14 Pcs.

27280 Heat Shrink Tube 3/16" 16 Pcs.

27290 Heat Shrink Tube 1/4" 14 Pcs.

27300 Heat Shrink Tube 3/8" 8 Pcs.

27310 Heat Shrink Tube 1/2" 8 Pcs.



26250 LOW CIRCUIT TESTER

Quick Check Both AC and DC Current Up to 12 Volts with Power On.

Helps locate shorts or breaks in wiring. Complete with insulated grounding clip.

26250 Low Circuit Tester. Skin-packed. Shipping wt. 3 oz.

26270 Replacement Bulb



28830 DIGITAL CIRCUIT TESTER 3-49V

Heavy-Duty Circuit Tester with Digital LCD Display to Accurately Show DC Voltage.

Operating range of 3-49 volts DC to work on most vehicle electrical systems. Two LEDs provide 360° visibility of polarity. The red light indicates positive polarity, green indicates negative polarity. Long, 12ft. coil cord and heavy-duty alligator clamp for secure connections. The probe is insulated to prevent the possibility of shorting the side of the probe to other components. Computer safe. Will not damage sensitive electronic components. Not for use on airbags.

28830 Digital Circuit Tester 3-49V. Plastic Tube with Insert Card. Shipping wt. 8.5 oz.

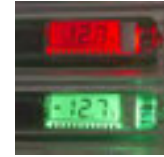

YouTube

29050 DIGITAL CIRCUIT TESTER 3-30V

Circuit Tester with Digital LCD Display to Accurately Show DC Voltage.

Two LEDs provide 360° visibility of polarity. The probe is insulated to prevent the possibility of shorting the side of the probe to other components. Computer safe. Will not damage sensitive electronic components. Not for use on airbags. Operating range 3-30 volts DC to work on most vehicle electrical systems. 47" cord and heavy-duty alligator clamp for secure connections.

29050 Digital Circuit Tester 3-30V. Skin Pack Card. Shipping wt. 5 oz.



YouTube

27430 24 VOLT HEAVY-DUTY CIRCUIT TESTER

Quickly Tests Voltage up to 28 Volts.

Works on any circuit up to 28 volts including many heavy duty applications on large trucks and farm implements. Heavy duty probe, cord and clamp. The probe is insulated with high-visibility shrink tubing to prevent the possibility of shorting the side of the probe to other components. Comes with a strain relief spring on the cord.

27430 24 Volt Heavy-Duty Circuit Tester. Skin-packed. Shipping wt. 8 oz.

27460 24 Volt Bulb

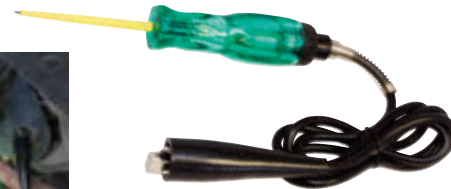

32900 HEAVY DUTY CIRCUIT TESTER / JUMPER

A 2-in-1 Tester that Tests Circuits up to 12 Volts and Works as a Jumper Wire for Power or Ground.

Heavy-duty circuit tester for checking low voltage up to 12 volts. By depressing the red button the tester becomes a jumper for powering electrical components or a ground. The probe, handle, cord and clamp are reinforced for durability. Comes with a strain relief spring on the cord.

32900 Heavy Duty Circuit Tester / Jumper. Skin-packed. Shipping wt. 7 oz.

28440 Replacement Bulb

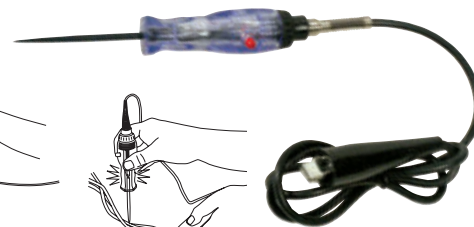
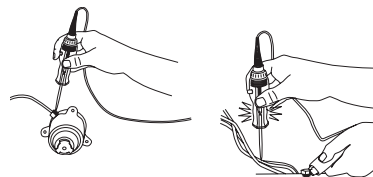

28400 HEAVY DUTY CIRCUIT TESTER

Quickly Tests Low Voltage up to 12 Volts.

A heavy duty circuit tester for lifetime use. The probe, handle, cord and clamp are reinforced for extra durability. Comes with a strain relief spring on the cord.

28400 Heavy Duty Circuit Tester. Skin-packed. Shipping wt. 7 oz.

28440 Replacement Bulb

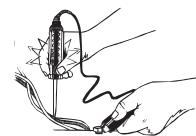

24550 COMPUTER SAFE CIRCUIT TESTER

Also Indicates Polarity.

Safe for automotive computers. Won't damage sensitive electronic components. Draws less than 21 mA. at 12 volts DC. Operating range 3-28 volts. The red light indicates positive polarity, green indicates negative polarity.

24550 Computer Safe Circuit Tester. Skin-packed. Shipping wt. 6 oz.

24560 Replacement Bulb

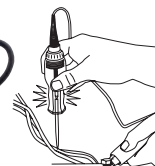

26330 LED CONTINUITY TESTER

Checks the Ability of Wires, Fuses, Switches or other Electrical Circuits to Carry Current.

Clip lead to end of the wire in question. Probe the other end of the wire. If the bulb lights up, continuity exists. If the bulb fails to light, the circuit is open. Incidental contact with 12V supply will not burn out LED bulb. Not a circuit tester. Do not use on live circuits. Includes one A23 battery.

26330 LED Continuity Tester. Skin Pack Card. Shipping wt. 3 oz.



YouTube

29500 HIGH-LOW CIRCUIT TESTER

Checks Both Low Voltage and Spark Plug Wires.

The low-side checks AC and DC current up to 28 volts with power on. The high-side checks spark plug wires without piercing. Complete with insulated clip.

29500 High-Low Circuit Tester. Skin-packed. Shipping wt. 3 oz.

19370 High End Bulb

26270 Low End Bulb



CHECKING LOW VOLTAGE



CHECKING SPARK PLUG WIRES

28640 THE ULTIMATE CIRCUIT TESTER KIT

Heavy Duty Tester Signals With a Light and Buzzer.

The tester kit tests low voltage up to 28 volts. Also finds electrical shorts, checks polarity, detects battery drain, and checks circuits from a distance. Heavy-duty coil cord extends over 8 feet. Detachable, spring-loaded hook pulls the center of the wire into the probe every time. Attach alligator clip to the probe when a clip-on connection is needed.

28640 The Ultimate Circuit Tester Kit. Clam Shell. Shipping wt. 10 oz.

28760 Replacement Bulb

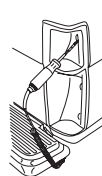

DISTANCE TESTING

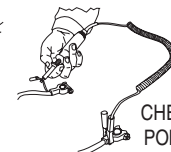

CHECKING POLARITY

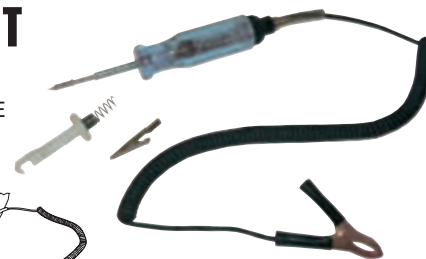

25600 "HANDY HOOKER" CIRCUIT TESTER

Hooded Probe Protects Your Fingers and Automatically Centers the Wire.

Small size allows easy use even in the tightest places. Quickly test low voltage up to 12 volts. Alligator clip grounds tester.

25600 Circuit Tester. Skin-packed. Shipping wt. 3 oz.

28440 Replacement Bulb



67870 STANDARD / HIGH ENERGY SPARK PLUG GAUGE & GAPPER

Gauges and Gaps all Types of Spark Plugs from .020" to .100" (.50mm to 2.53mm).

Tapered edge for gauging spark plugs. Specially designed hole with flange adjusts side wire of plug without pressuring center electrode.

67870 Standard/High Energy Spark Plug Gauge & Gapper. Skin-packed.

Shipping wt. 1 oz.

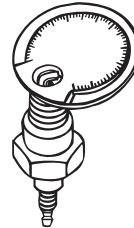

GAPPING

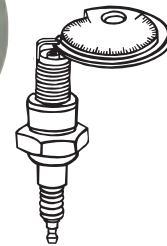

GAUGING

67800 67900 SPARK PLUG GAPPERS

For Standard and Electronic Ignitions.

67800 for standard ignition. 67900 for electronic ignition.

67800 Standard Spark Plug Gapper. Skin-packed. Shipping wt. 2 oz.

67900 Electronic Ignition Spark Plug Gapper. Skin-packed. Shipping wt. 2 oz.

67800	
Inches	mm
.025	.64
.030	.76
.034	.86
.035	.89
.040	1.02
.045	1.14



67800



67900

67900	
Inches	mm
.040	1.02
.044	1.12
.045	1.14
.050	1.27
.060	1.52
.080	2.03

68100 DELUXE FEELER GAUGE

31 Blades. 1 Brass Blade .010".

Precision blades ensure accurate measurements. Blades from .0015" to .035" (.038 - .889mm) thickness are approximately 1/2" wide by 3-1/2" long.

68100 Deluxe Feeler Gauge. Skin-packed. Shipping wt. 5 oz.

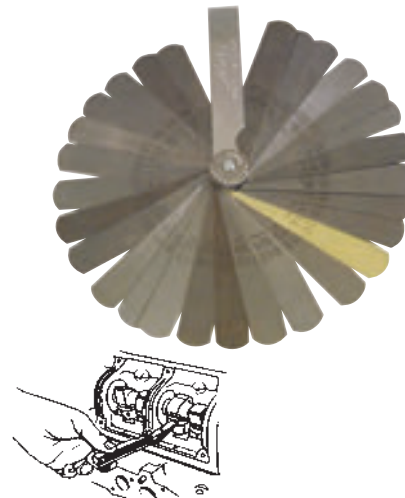

Blade Sizes			
Inches mm		Inches mm	
.0015	.038	.016	.406
.002	.051	.017	.432
.0025	.064	.018	.457
.003	.076	.019	.483
.004	.102	.020	.508
.005	.127	.021	.533
.006	.152	.022	.559
.007	.178	.023	.584
.008	.203	.024	.610
.009	.229	.025	.635
.010	.254	.026	.660
.011	.279	.028	.711
.012	.305	.030	.762
.013	.330	.032	.813
.014	.356	.035	.889
.015	.381		

68000 MINI FEELER GAUGE

16 Steel Blades.

Precision blades ensure accurate measurements. Blades from .010" to .035" (.254 - .889mm) are approximately 1/4" wide by 1-3/4" long.

68000 Mini Feeler Gauge. Skin-packed. Shipping wt. 1 oz.



Blade Sizes	
Inches	mm
.010	.254
.012	.305
.013	.330
.015	.381
.016	.406
.017	.432
.018	.457
.020	.508
.022	.559
.024	.610
.025	.635
.026	.660
.028	.711
.030	.762
.032	.813
.035	.889



67950 STANDARD FEELER GAUGE

15 Steel Blades. One 2" Steel Rule.

Precision blades ensure accurate measurements. Blades are approximately 1/2" wide by 3-1/2" long.

67950 Standard Feeler Gauge. Skin-packed. Shipping wt. 3 oz.

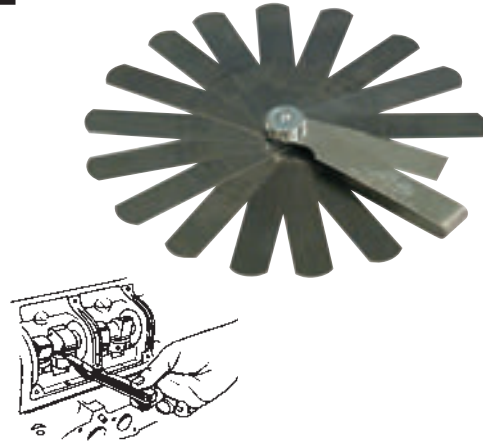

Blade Sizes	
Inches	mm
.002	.051
.003	.076
.004	.102
.005	.127
.006	.152
.008	.203
.011	.279
.012	.305
.013	.330
.014	.356
.016	.406
.018	.457
.020	.508
.022	.559
.025	.635

68050 VALVE TAPPET FEELER GAUGE

11 Offset Steel Blades.

Precision blades are offset at the proper angle for adjustment of valve tappets. Blades are approximately 1/2" wide by 4" long.

68050 Valve Tappet Feeler Gauge. Skin-packed. Shipping wt. 3 oz.

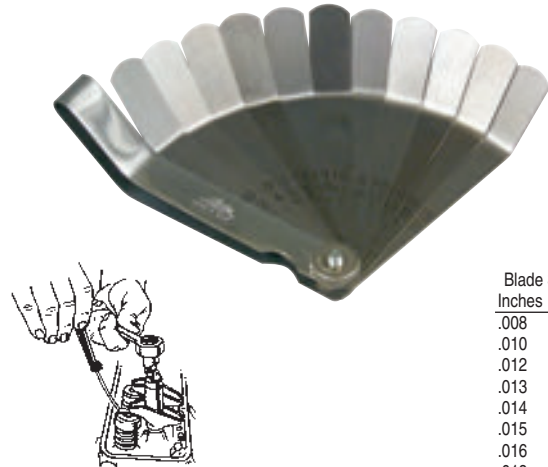

Blade Sizes	
Inches	mm
.008	.203
.010	.254
.012	.305
.013	.330
.014	.356
.015	.381
.016	.406
.018	.457
.019	.483
.020	.508
.026	.660

68150 GO-NO-GO FEELER GAUGE

22 Steel Blades.

Precision stepped blades have a .002" step for accurate settings. Blades from .004" to .027" (.102 - .686mm) are approximately 1/2" wide by 3-1/4" long.

68150 Go-No-Go Feeler Gauge. Skin-packed. Shipping wt. 4 oz.

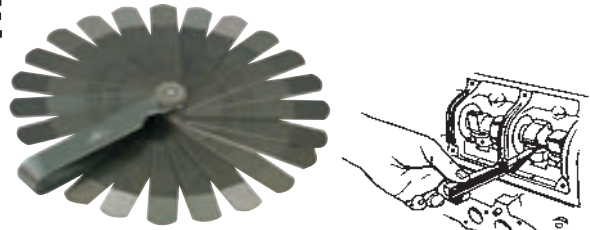

Blade Sizes

Inches		mm		Inches		smm	
Low	High	Low	High	Low	High	Low	High
.004	.006	.102	.152	.015	.017	.381	.432
.005	.007	.127	.178	.016	.018	.406	.457
.006	.008	.152	.203	.017	.019	.432	.483
.007	.009	.178	.229	.018	.020	.457	.508
.008	.010	.203	.254	.019	.021	.483	.533
.009	.011	.229	.279	.020	.022	.508	.559
.010	.012	.254	.305	.021	.023	.533	.584
.011	.013	.279	.330	.022	.024	.559	.610
.012	.014	.305	.356	.023	.025	.584	.635
.013	.015	.330	.381	.024	.026	.610	.660
.014	.016	.356	.406	.025	.027	.635	.686

40200 40210 3/8" MAGNETIC SOCKET HOLDERS

Organizes 3/8" Fractional & Metric Sockets.

28 socket compartments that allow you to keep your 3/8" standard and deep sockets in one convenient holder. Holds sockets up to 1" or 24mm. Design of holders leaves sockets exposed for easy identification. Powerful magnets securely hold sockets in tray, & tray to any steel surface. Made of strong ABS plastic. Fits most 3/8" sets.

40200 3/8" Magnetic Socket Holder, Red. Hang Card. Shipping wt. 2 lbs. 3 oz.

40210 3/8" Magnetic Socket Holder, Black. Hang Card. Shipping wt. 2 lbs. 3 oz.

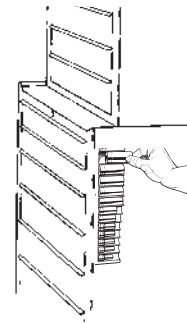
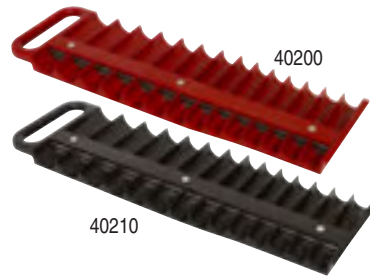

40120 40130 1/4" MAGNETIC SOCKET HOLDERS

Organizes 1/4" Fractional & Metric Sockets.

26 socket compartments allow you to keep your 1/4" standard and deep sockets in one convenient holder. Holds sockets up to 5/8" or 15mm. Design of holders leaves sockets exposed for easy identification. Powerful magnets securely hold sockets in tray, and tray to any steel surface. Made of strong ABS plastic.

40120 1/4" Magnetic Socket Holder, Red. Hang Card. Shipping wt. 1 lb. 3 oz.

40130 1/4" Magnetic Socket Holder, Black. Hang Card. Shipping wt. 1 lb. 3 oz.

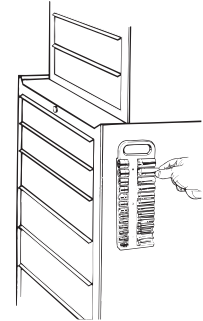

40900 40990 1/2" MAGNETIC SOCKET HOLDERS

Organizes 1/2" Chrome & Impact Sockets.

22 socket compartments allow you to keep your 1/2" standard and deep sockets in one convenient holder. Holds sockets up to 1" or 20mm. Design of holders leaves sockets exposed for easy identification. Powerful magnet holds sockets in tray. Rubber feet protect tool box from scratching. Made of strong ABS plastic. Will fit impact sockets.

40900 1/2" Magnetic Socket Holder, Red. Hang Card. Shipping wt. 2 lbs. 9 oz.

40990 1/2" Magnetic Socket Holder, Black. Hang Card. Shipping wt. 2 lbs. 9 oz.

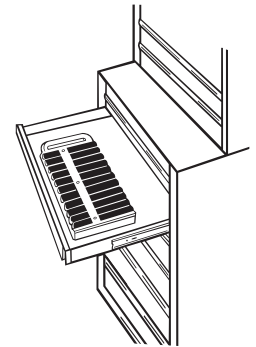

21300 21400 MAGNETIC TOOL HOLDERS

21300 - 13" Length. 21400 - 24" Length.

Powerful Magnet Holds Even Heavy Hand Tools.

Ideal for both home and shop.

21300 13" Magnetic Tool Holder. Skin-packed. Shipping wt. 2 lbs. 4 oz.

21400 24" Magnetic Tool Holder. Skin-packed. Shipping wt. 4 lbs. 4 oz.

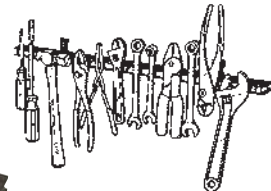

67300 MULTI-POSITION MAGNETIC NUT CUP

Strong Magnetic Base that Attaches Securely to Vehicles, Tool Boxes, Bins, Hoists and any Other Ferrous Metal Object.

The magnet has a coating to protect work surfaces and is oil and fuel resistant. Angled cup design allows positioning vertically, horizontally, or any angle in between. The 6" diameter cup is made of ABS plastic for durability. The strong magnet can hold up to 5 lbs. in a vertical position.

67300 Multi-Pos Mag Cup. Box with Color Label. Shipping wt. 1 lb.

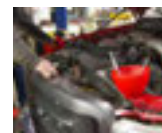

40460 40490 PLIERS & WRENCH RACKS

Keeps Toolboxes Neat and Organized.

By holding pliers and wrenches vertically, tools take up less space in the toolbox while keeping them easy to identify, locate and grab. Thirteen slots hold various shapes and sizes of wrenches and pliers. Ten 5/8" wide slots for narrow tools and three 7/8" wide slots for larger tools. Only 1-5/8" tall. Specially designed slot allows thinner pliers and wrenches to remain vertical. Made of durable molded plastic.

40460 Pliers & Wrench Rack - Black. Hang Card. Shipping wt. 14.2 oz.

40490 Pliers & Wrench Rack - Red. Hang Card. Shipping wt. 14.2 oz.



BEFORE

AFTER

U.S. Pat No. D673,391

20130 MAGNETIC GLOVE DISPENSER

Magnetic Glove Dispenser Conveniently Attaches to Your Toolbox or Any Ferrous Metal Surface.

Two large magnets hold the dispenser in place. Or, mount it on a wall using the screw slots provided. Fits all common sizes of disposable rubber glove boxes, both 50 and 100 packs. The dispenser has 3 adjusting springs which can be adjusted as necessary to hold the various box sizes. Made of powder-coated steel.

20130 Magnetic Glove Dispenser. Boxed. Shipping weight 1 lb. 10 oz.

Available in 6 pack boxes only for product protection.

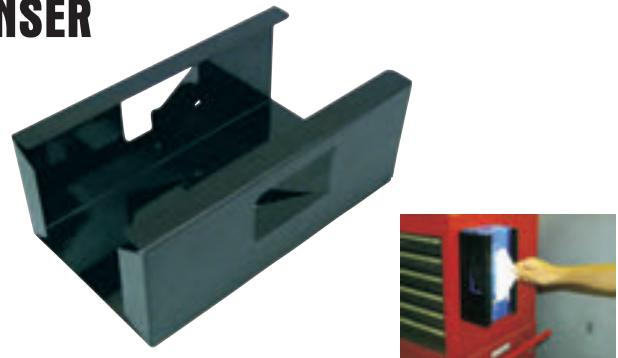

U.S. Pat No. 6,820,753

49960 LOCKING AIR TOOL HOLDER

Organize Air Tools with this Lockable Tool Holder.

Tool can hold up to five pneumatic tools in a 10" space. Comes with five slots that fit all popular quick connect fittings from Milton, Lincoln, Amflo and others. Can be mounted on a tool box, cart or wall for easy access. Locking feature protects your air tools from theft (lock not included). Durable powder-coated finish.

49960 Locking Air Tool Holder. Clam Shell. Shipping wt. 13 oz.

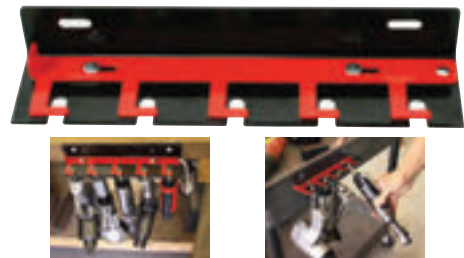

50350 SIDE WINDER AIR HOSE REEL

Coil & Uncoil Your Air Hose Neatly & Quickly.

The Side Winder Air Hose Reel provides a large 10" diameter reel to prevent tight coils in your air hose. Two built-in tool hangers keeps air chuck, blow gun or other air tools handy. The 1/4" NPT brass swivel keeps air flowing freely & handles up to 250 P.S.I.. A coil spring brake keeps reel from unrolling, yet allows easy dispensing of hose. Versatile installation — can be fastened in any direction — on or under a bench, on a wall, from the ceiling, on a compressor or on a service truck. The all steel construction with durable powder baked paint finish is made to last. Supplies 28 C.F.M. at 90 P.S.I. Reel holds 150 feet of 5/8" O.D. hose or 100 feet of 3/4" O.D. hose. Dimensions: Diameter 17-3/4", Width 11", Height 19".

50350 Air Hose Reel. Display Box. Shipping wt. 9 lbs. 3 oz.

50310 Swivel Joint

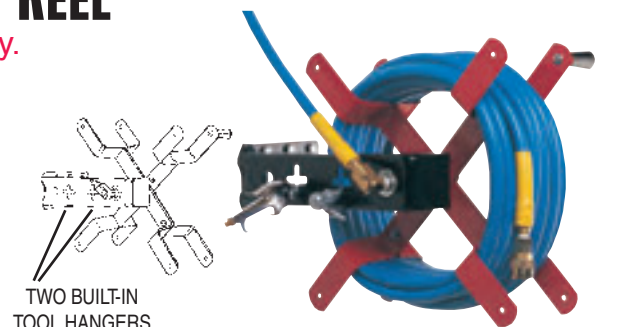

TWO BUILT-IN TOOL HANGERS

Air Hose and Air Tools Not Included.



MAGNETIC/ORGANIZERS

31000 66500 MAGNETIC PICK-UP TOOLS

Will Retrieve Parts and Tools from Hard to Reach Places.

Magnet shielded to concentrate magnetic field at end of tool. 31000 and 66500 have a super strong neodymium magnet. 31000 extends from 14-1/2" to 23-1/4". 31250 total length 9-1/2". 66500 telescopes from 4-1/2" to 16-1/4".

31000 Magnetic Pick-Up Tool. Skin-packed. Shipping wt. 7 oz.

66500 Telescoping Magnetic Pocket Pick-Up. Skin-packed. Shipping wt. 2 oz.

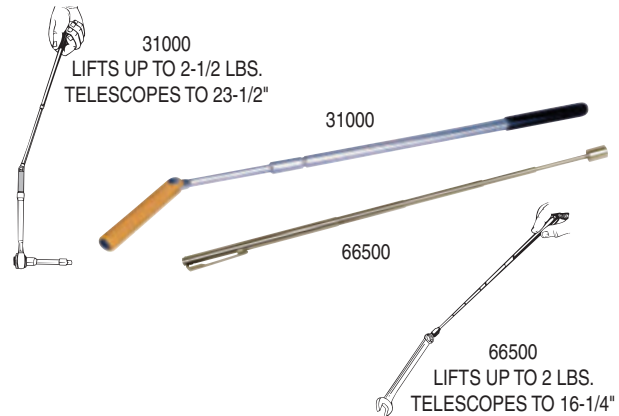

66540 MINI FLEXIBLE MAGNETIC PICK UP TOOL

Super Strong Neodymium Magnet Picks Up All Ferrous Metal Objects Up to 2 lbs.

Adjustable telescoping action extends from 4-1/2" to 13" with a 2-1/2" flexible segment to get into tight spots.

66540 Mini Flexible Magnetic Pick Up Tool. Skin-packed. Shipping wt. 2 oz.

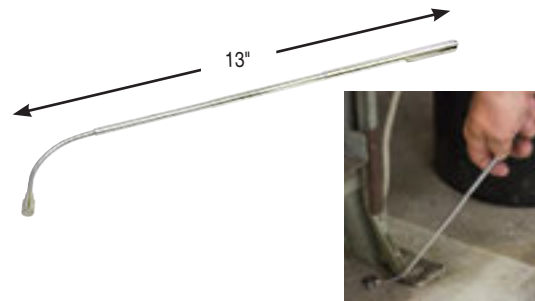

66580 FLEXIBLE 23-1/2" MAGNETIC PICK-UP TOOL

Adjustable Telescoping Action Extends from 5-3/8" to 23-1/2" with a 3-1/2" Flexible Segment that Holds Its Shape.

Super strong neodymium magnet picks up all ferrous metal objects up to 2.5 lbs.

66580 Heavy-Duty Flexible Magnetic Pick-Up Tool. Skin Packed. Shipping wt. 2 oz.

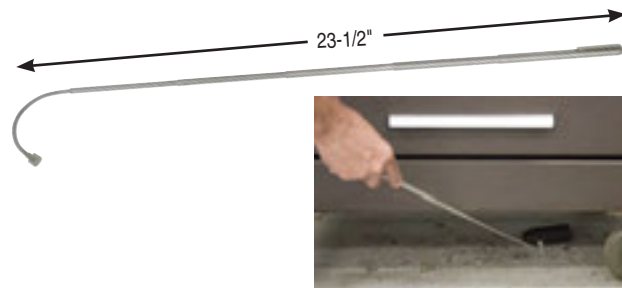

31140 23" FLEXIBLE RETRIEVING TOOL

Picks Up Loose Parts in Hard-To-Reach Areas.

23" flexible cable allows you to get into hard-to-reach areas. Simply push button on handle and fingers open 3/4" to grab small parts that you can't reach by hand.

31140 23" Flexible Retrieving Tool. Hang Card. Shipping wt. 3 oz.



32050 TELESCOPING MIRROR

Enables You To See Around Corners.

2-1/4" diameter mirror swivels to any position. Telescopes from 6-5/8" to 36-3/8". Textured handle provides sure grip.

32050 Telescoping Mirror. Skin-packed. Shipping wt. 5 oz.

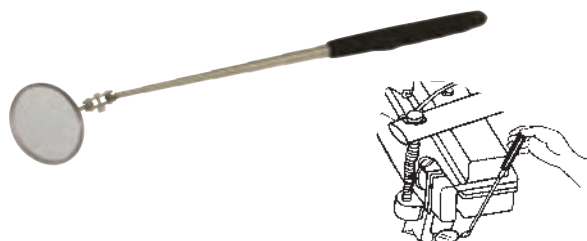

61090 61110 61130 DIESEL FILTER WRENCHES FOR DAVCO

Specially Designed Wrenches for Removing and Replacing the Main Filter Collar as well as the Vent Cap on Davco Aftermarket Diesel Fuel Filter Systems.

5", 6" and 8" wrenches with a unique half-moon design provide easier access to the fuel filter. High strength steel prevents the wrench from flexing while loosening stubborn filter collars. Four teeth grab the vent cap securely to prevent damage. Thick padded grip cushions your hand.

61090 5" Diesel Filter Wrench for Davco. Color Label. Shipping wt. 1 lb. 2 oz.

61110 6" Diesel Filter Wrench for Davco. Color Label. Shipping wt. 1 lb. 4 oz.

61130 8" Diesel Filter Wrench for Davco. Color Label. Shipping wt. 1 lb. 13 oz.



YouTube

61060 DIESEL FILTER WRENCH FOR PACCAR

All Metal Wrench to Remove and Install Bowls on Newer Paccar Chassis Mounted Fuel Filter Assemblies.

Half-moon design allows easier access to the fuel filter found on Kenworth, Peterbilt and Cummins diesels. Laser-cut steel provides strength to loosen even the toughest bowls. Thick padded grip for comfort.

61060 Diesel Filter Wrench for Paccar. Color Label. Shipping wt. 13 oz.



YouTube

60200 HEAVY DUTY STRAP FILTER WRENCH

A Heavy-Duty Heat Treated Alloy Steel Yoke and Strong Web Strap.

Use with 1/2" drive to remove or install filters and other objects up to 6-1/2" in diameter. 3-5/8" long yoke fits into tight areas.

60200 Heavy Duty Strap Filter Wrench. Skin-packed. Shipping wt. 8 oz.



YouTube

61900 HEAVY DUTY BEARING RACE & SEAL DRIVER SET

Fits Most Class 8 Over the Road Trucks and Trailers and Some Medium Duty Trucks.

Use the tapered driver side for bearing races and the flat side for seals. Includes six drivers and handle extension for driving bearing races and seals on hubs with deep brake drums without removing the drums. For applications that do not need the length of the two-piece handle, use only the handle with the solid end.

Use the included hardened washer between the driver and handle to protect the aluminum driver.

61900 Heavy Duty Bearing Race & Seal Driver Set. Molded Case. Shipping wt. 9 lbs. 8 oz.



Drivers Included:

- 61910 4-7/8"
- 61920 4-13/16"
- 61930 5-1/2"
- 61940 5-25/32"
- 61950 6"
- 61960 3-43/64"



YouTube

61850 TRUCK HUB SEAL INSTALLER KIT

Fits the Most Popular Size Seals for Class 7 and Class 8 Over the Road Trucks and Trailers and Some Medium Duty Trucks.

The driver is designed to hold the seals to make installation easier. Includes five drivers and handle extension for extra reach for driving seals on hubs with deep brake drums without removing the drums.

61850 Truck Hub Seal Installer Kit. Molded Case. Shipping wt. 9 lbs. 13 oz.



Drivers Included: | Fit Seal #

- | | |
|----------------|---------|
| 61700 4-13/16" | 370001A |
| 61730 5-11/16" | 370023A |
| 61720 5-31/32" | 370025A |
| 61740 6" | 370065A |
| 61710 6-5/16" | 370003A |



YouTube

HEAVY DUTY

69700 69900 TURBO AIR SYSTEM TEST KITS

Helps Locate Air Leaks in Turbo System Components by Plugging the Output Side of the Turbo and the Intake Inlet.

Air is applied through one adapter to show the presence of leaks within the system. Features a pressure gauge, shut off valve and pressure regulator and includes pairs of stepped adapters to fit most turbo systems on Class 7 and 8 trucks. Can also be used on some cooling system hoses.

69700 Turbo Air System Test Kit, 13 pc. Molded Case. Shipping wt. 8 lbs. 12 oz.

69900 Turbo Air System Test Kit, 9 pc. Molded Case. Shipping wt. 9 lbs.

69710 31/38mm Plugged Adapter

69720 31/38mm Air Fitting Adapter

69730 46/51mm Plugged Adapter

69740 46/51mm Air Fitting Adapter

69750 55/60mm Plugged Adapter

69760 55/60mm Air Fitting Adapter

69770 65/70mm Plugged Adapter

69780 65/70mm Air Fitting Adapter

69790 75/80mm Plugged Adapter

69800 75/80mm Air Fitting Adapter

69810 85/90mm Plugged Adapter

69820 85/90mm Air Fitting Adapter

69850 95/100mm Plugged Adapter

69860 95/100mm Air Fitting Adapter

69870 105/110mm Plugged Adapter

69880 105/110mm Air Fitting Adapter

69840 Air Regulator Hose and Gauge



69700 Adapters



69900 Adapters



See Video on
www.lislecorp.com or
Our YouTube Channel.



Fits Hose I.D.		69700	69900
31/38 mm	1-1/4" / 1-1/2"	X	
48/51 mm	1-7/8" / 2"	X	
55/60 mm	2-1/8" / 2-3/8"	X	
65/70 mm	2-1/2" / 2-3/4"	X	
75/80 mm	3" / 3-1/8"	X	X
85/90 mm	3-3/8" / 3-1/2"	X	X
95/100 mm	3-3/4" / 4"		X
105/110 mm	4-1/8" / 4-1/4"		X

HEAVY DUTY

19852 TRUCK & TRAILER WHEEL PAN

Catches Oil from Wheel Hubs After Removing Cap.

Prevents oil mess during wheel repair. The pan fits rims with 13-3/4" I.D. and larger. Handle compartments hold hub nuts out of the oil. Made of polypropylene for durability. Will not warp if oil is warm. Capacity 88 ounces.

19852 Truck & Trailer Wheel Pan. 8 per Master Pack. Shipping wt. 5 lbs. 12 oz.



U.S. Pat No. 6,454,121

49000 TRUCK SPRING CAGE BOLT SOCKET

Quickly Unlocks Truck Air Brakes.

Extra deep 3/4" socket loosens the cage bolt to unlock air brakes on trucks. Also removes the air brake booster for replacement. Use with a 1/2" drive or 7/8" hex. Can be used with an impact wrench.

49000 Truck Spring Cage Bolt Socket. Skin-packed. Shipping wt. 12 oz.

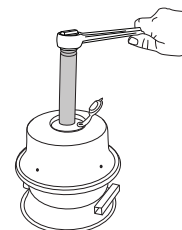

59600 DEUTSCH TERMINAL TOOL

Works on OEM Electrical Connectors Used on Trucks and Equipment Such as Caterpillar, Kenworth, Peterbilt, Freightliner, Mack & More.

Also used on some Harley Davidson and industrial equipment connectors. Slotted tubes are made from stainless steel which is more durable than plastic. Built in a convenient "spider" design so the most popular sizes are always available. To use, slide appropriate size slotted tube over wire. Push the tool into the grommet, bottoming out the tool on the terminal. DO NOT TWIST THE TOOL. Pull the wire-terminal out of the connector.

59600 Deutsch Terminal Tool. Skin-packed. Shipping wt. 2 oz.

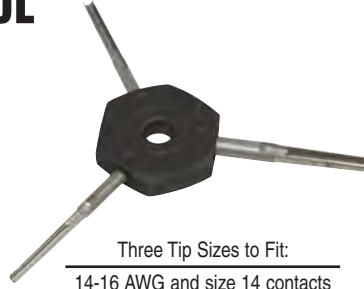

Three Tip Sizes to Fit:
 14-16 AWG and size 14 contacts
 16-18 AWG and size 18 contacts
 20-24 AWG and size 20 contacts

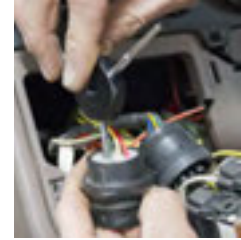

28870 TRUCK ANCHOR PIN BUSHING DRIVER

Pneumatic Bushing Driver Set Removes and Installs Truck and Trailer 1-3/8" Anchor Pin Bushings and Stuck Anchor Pins.

Includes a 7-3/4" extension that allows bushings to be driven straight without removing the hub assembly. Drive the bushing out with the small cone. Use the larger cone to install bushing to the proper depth. Also removes truck leaf spring bushings.

28870 Truck Anchor Pin Bushing Driver. Skin Packed. Shipping wt. 2 lbs. 2 oz.

28900 Driver	28910 Remover Cone
28920 Installer Cone	41470 Extension



Removing



Installing



28890 TRUCK ANCHOR PIN BUSHING DRIVER

Also Removes Truck Leaf Spring Bushings.

Pneumatic bushing driver set removes and installs truck and trailer anchor pin bushings and stuck anchor pins. Drive the bushing out with the small cone. Use the larger cone to install bushing to the proper depth.

28890 Truck Anchor Pin Bushing Driver. Skin-packed. Shipping wt. 1 lb. 2 oz.

28900 Driver	28910 Remover Cone
28920 Installer Cone	

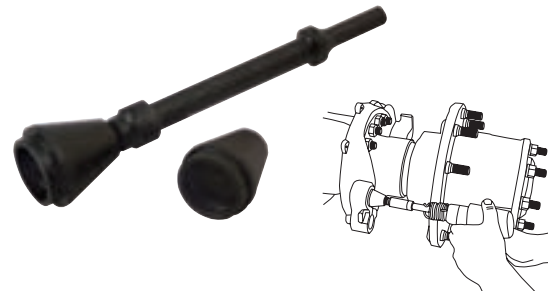

21520 TRUCK PEDAL DEPRESSOR

Depresses & Holds Clutch Pedals & Brake Pedals.

The two-piece, telescoping tool extends to pedal & locks in position. Brace the formed plate against the seat or steering wheel for support. Tool extends from 18-1/2" to 34-1/2".

21520 Truck Pedal Depressor. Skin-packed. Shipping wt. 2 lb.s 4 oz.

45980 Replacement Rubber Tip

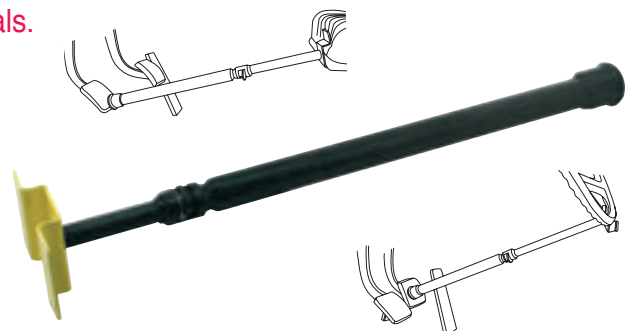

52600 ABRASIVE PAD SCRAPER

The 30° Angle Provides Extra Leverage when Cleaning Gasket Surfaces.

Pad wraps around the end of the tool to reach into tight corners and can be repositioned on the tool as it wears. Comes with three quickly and easily replaceable 1" x 4" medium grit pads.

52600 Abrasive Pad Scraper. Skin-packed. Shipping wt. 7 oz.

52640 Abrasive Pad



52000 RAZOR BLADE SCRAPER

Designed to Reach Tight Places.

Comes with five stainless steel blades for removing stickers from windshields, bumpers, etc. Also comes with a plastic blade for use on safety plastic laminated windshields to prevent scratching. Spring-release allows easy interchange of blades. Reverse blade in holder for storage. Hollow handle stores all blades when not in use.

52000 Razor Blade Scraper. Skin-packed. Shipping wt. 7 oz.

51320 Replacement Blades. 5 piece set stainless steel blades.

52080 Replacement Blades. 5 piece set plastic blades.

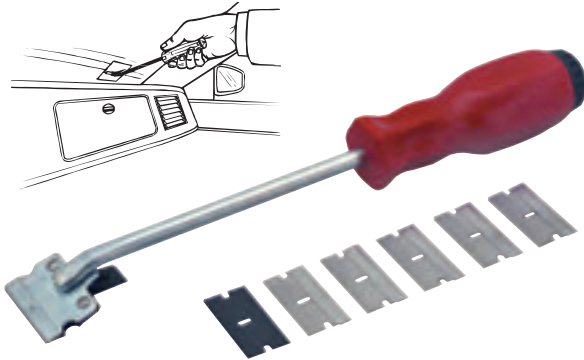

52400 FOLD-UP SCRAPER

Blade Folds into the Handle for Safe, Convenient Storage.

The fold-up scraper features three arm positions and a slanted blade for proper scraping. Great for removing decals, bumper stickers, labels, etc. The quick change blade holder firmly holds a single edge razor blade. Includes 1 single edge razor blade. Overall length 7-3/4".

52400 Fold-Up Scraper. Skin-packed. Shipping weight 4 oz.

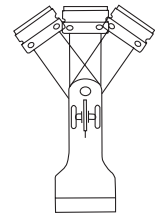

LOCKS IN THREE DIFFERENT POSITIONS

52150 100 PACK OF RAZOR BLADES

Convenient Pack of Standard Razor Blades.

Contains 100 stainless steel, single edged razor blades. Pack is resealable for storage. Fits all standard razor blade tools, including Lisle 52000 Razor Blade Scraper.

52150 100 Pack of Razor Blades. Clam Shell Package. Shipping wt. 12 oz.



51000 HEAVY DUTY SCRAPER

Sharp Steel Blade Quickly Peels Off Carbon, Sludge.

Sharp, hardened steel blades remove carbon, old gasket material, adhesives, sludge and other hard-to-clean substances from blocks, heads, etc. Comes with three blades. 1", 1-1/2" and 2" widths. Tool will hold single edge razor blade for bumper stickers and decals.

51000 Heavy Duty Scraper. Skin-packed. Shipping wt. 7 oz.

Replacement Blades

Part No.	Size
51120	Six 1" blades
51130	Six 1-1/2" blades
51140	Six 2" blades

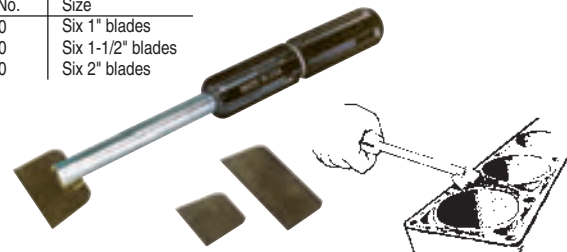

51350 PUTTY KNIFE

1-1/4" Stiff, Tempered Steel Blade.

Ideal for scraping old putty, paint, dirt & carbon. Can also be used for applying putty. One piece blade has a satin finish. Handle is made of polypropylene for easy cleanup.

51350 1-1/4" Putty Knife. Skin-packed. Shipping wt. 3 oz.



31310 DOUBLE FLARING TOOL SET

Makes Both Single and Double SAE Flares.

This tool set includes everything to flare thin wall steel, aluminum or .040 wall soft copper tubing. The set includes 5 thread dies and adapters for forming double flares on the following tubing sizes: 3/16", 1/4", 5/16", 3/8" and 1/2". However, this set is not for use on stainless steel tubing. Full instructions are included.

31310 Double Flaring Tool Set. Clam Shell. Shipping wt. 2 lbs. 1 oz.

31130 Long Bar 31180 3/8" Adapter

31370 3/16" Adapter 31380 1/4" Adapter

31390 5/16" Adapter 31410 1/2" Adapter

U.S. Pat No. 6,199,421

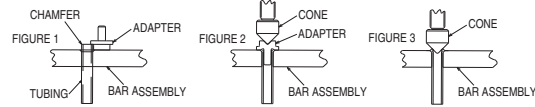

56150 COMBINATION FLARING TOOL

Works for Single and Double Flares, Also ISO (Bubble) Flares.

This set includes all the adapters and tools necessary for single and double flaring (standard and metric) plus the ISO (bubble) flare. Works on aluminum, copper and soft steel tubing. Not recommended for stainless steel. The set is packed in a plastic molded storage case with complete instructions.

56150 Combination Flaring Tool. Molded Case. Shipping wt. 3 lbs. 8 oz.



Part #	Description
31180	3/8" Adapter
31370	3/16" Adapter
31380	1/4" Adapter
31390	5/16" Adapter
31410	1/2" Adapter
56220	6mm Adapter
56240	10mm Adapter
56270	4.75mm ISO Adapter
56300	6mm ISO Adapter
56330	8mm ISO Adapter
56360	10mm ISO Adapter

44000 TUBING BENDER

Bends 4 Sizes.

Easy to use with one end connected - or can be mounted in a vise. Exclusive nylon form prevents kinking or flattening. For 3/16", 1/4", 5/16" and 3/8" O.D. tubing. Not recommended for 3/8" steel.

44000 Tubing Bender. Skin-packed. Shipping wt. 15 oz.

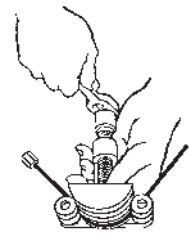

44150 3/16" TUBING BENDER PLIERS 44070 1/4" TUBING BENDER PLIERS

Bends Brake Lines Without Kinking or Flattening, Especially in Tight Spots.

Bends all types of 3/16" and 1/4" OD tubing. Unique head design bends tubing without collapsing the tube. Won't mark tube surface. The handles are more than 3-1/4" apart for proper leverage when handling even steel tubing and unique head design on 44070 keeps handles in line with the tubing.

44070 1/4" Tubing Bender Pliers. Skin-packed. Shipping wt. 10 oz.

44150 3/16" Tubing Bender Pliers. Skin-packed. Shipping wt. 9 oz.

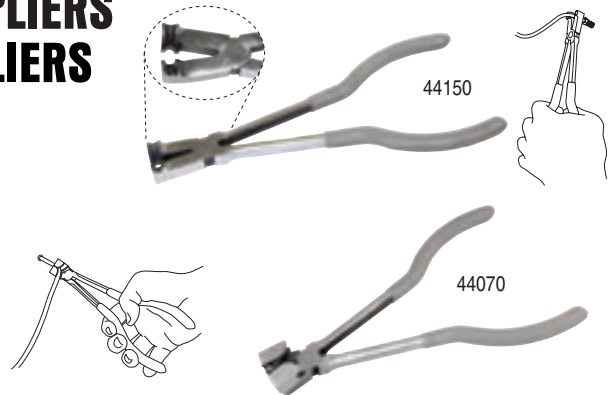

50000 MINI-CUTTER

Smooth Nylon Action Cuts Tubing Quickly.

Easy-to-use Mini-Cutter features all nylon construction, giving you smoother, easier operation & longer tool life. Used in tight places right on the car. For all types of metal tubing. Handles smallest tubing to 5/8" O.D. Completely non-corrosive.

50000 Mini-Cutter. Skin-packed. Shipping wt. 2 oz. NSN 5110-00-965-0878

50050 Replacement Cutter

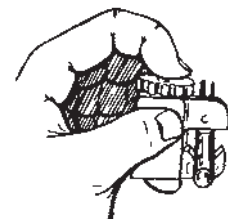

47900 HOSE REMOVER PLIERS

For Easy Removal of 5/32" to 1/2" Vacuum and Fuel Hoses.

Engage the tube (line) with the black jaw. This sharpened jaw actually "DIGS" into the tube to grip it! Squeeze and the hose is easily pushed off by the silver jaw.

47900 Hose Remover Pliers. Skin-packed. Shipping wt. 7 oz.

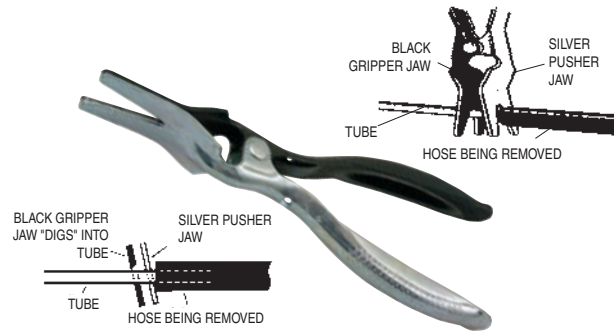

17100 FLAT BAND HOSE CLAMP PLIERS

Adjustable Jaws Fit All Clamp Sizes for Easy Removal and Installation.

This tool removes and installs flat band hose clamps used on heater and radiator hoses. Tips screw in and out to fit all clamp sizes. Ratcheting lock mechanism holds the clamp in an open position for easy removal and installation. Tips can be switched to accommodate different applications. Offset jaws allow access in hard-to-reach areas.

17100 Flat Band Hose Clamp Pliers. Skin-packed. Shipping wt. 1 lb. 1 oz.

17120 Hollow Tip

17220 Slotted Tip

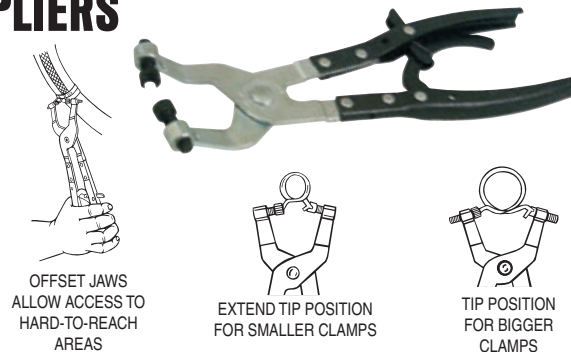

44480 44500 HOSE CLAMP VISES

Vise Design Fits in Tight Spots. 44500 is 3" Long and Opens to 1-1/2". 44480 is 3-5/8" Long and Opens to 2-1/8".

Tool are used to relieve clamp spring pressure in very tight spots. Vise is often left in place, with the clamp compressed. Ramp on jaws guides tab of clamp into correct position and traps it in the slot for safety. Tighten knurled knob by hand or use 1/4" drive ratchet. Can also be used on round wire clamps found on Detroit Diesel applications.

44480 Hose Clamp Vise. Skin-packed. Shipping wt. 5 oz.

44500 Hose Clamp Vise. Skin-packed. Shipping wt. 5 oz.

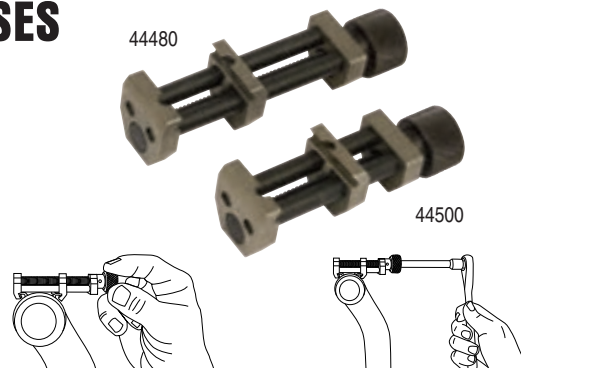

U.S. Pat No. 7,127,787

11420 HOSE CUTTER

Cuts Flexible Hose up to 1-1/4".

The Hose Cutter will cleanly cut heater hoses, fuel lines, and other types of flexible hose up to 1-1/4". The stainless steel blade is reversible for double the life. Plier is made of glass-filled nylon for strength.

11420 Hose Cutter. Skin-packed. Shipping wt. 11 oz.

11450 Replacement Blade

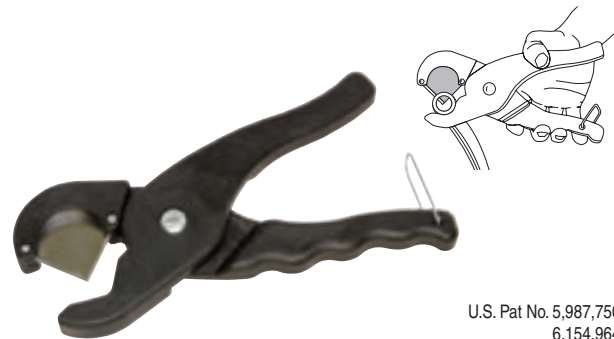

23000 HOSE PINCHER

Clamps And Holds Hoses Up To 3/4" I.D.

Angled jaws close to create a complete seal every time. Jaws are offset for hard-to-reach areas. The handles lock firmly to hold the jaws in a closed position. Frees both hands to do the work. Used on brake hoses, vacuum hoses, heater hoses and all flexible rubber hose. Made of glass-filled nylon for extra strength.

23000 Hose Pincher. Skin-packed. Shipping wt. 6 oz.

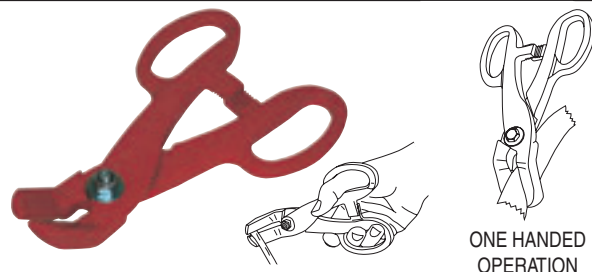

80380 HOSE REMOVER SET, 5 PC.

Set of Five Hose Removers with Many Uses.

Contains long and short, standard and offset hooks. Can be used to remove hoses, moldings, clips, clamps, seals, o-rings, cotter pins, gaskets, etc. Long pullers are 13" long. Handles are dual material for comfort and grip. Rods are heat-treated for strength and plated for durability. All hose removers are available individually skin-packed.

80380 Hose Remover Set. Skin-packed. Shipping wt. 1 lb. 4 oz.

80210 Short Hose Remover 80220 Long Hose Remover

80230 Short Offset Remover 80240 Long Offset Remover

80290 Short Double Offset Remover

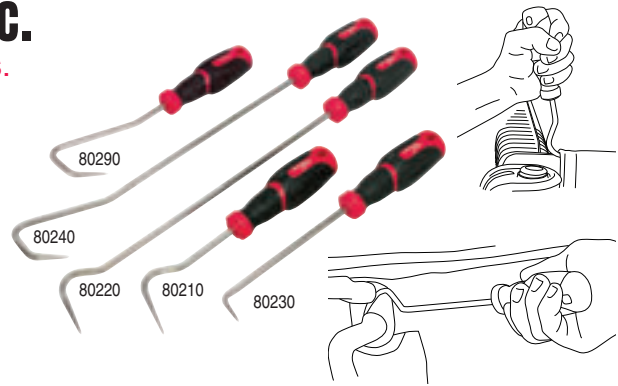

22850 HOSE PINCHERS

A quick, easy way to pinch off vacuum lines, fuel lines, brake lines, etc. without damaging the line. Sold two per set.

22850 Hose Pinchers. Skin-packed. Shipping wt. 5 oz. (2 per set)

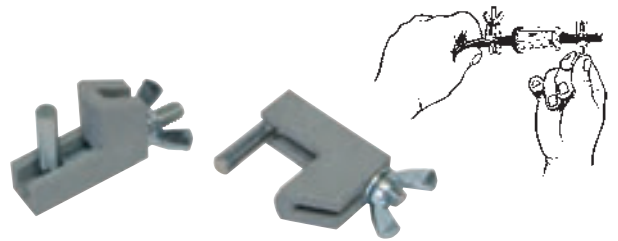

67000 MASTER LINE STOPPER SET

For Internal and External Lines.

The set includes four stoppers to seal lines in automotive flare type steel brake lines, power steering and transmission cooler lines. Two line clamp pliers 6-1/4" and 7-1/4" in length seal flexible brake lines, fuel and vacuum lines. Smooth rounded edges will not damage internal hose reinforcement. Eight stoppers and four caps are used for plugging vacuum and fuel lines. Stepped design can be used for both internal and external lines. Stopper sizes from 1/8" through 1/2". Caps are 5/8" and 3/4" for larger lines.

67000 Master Line Stopper Set. Molded Case. Shipping wt. 2 lbs. 1 oz.

67030 Line Stopper 1/8" (2) 67040 Line Stopper 3/16"-1/4" (2)

67050 Line Stopper 5/16"-3/8" (2) 67060 Line Stopper 7/16"-1/2" (2)

67070 Line Stopper Cap 5/8" (2) 67080 Line Stopper Cap 3/4" (2)

67090 Line Clamp Pliers Small 67100 Line Clamp Pliers Medium

67110 Steel Line Stopper 1/4" 67120 Steel Line Stopper 5/16"

67130 Steel Line Stopper 3/8" Banjo 67140 Steel Line Stopper 3/8"

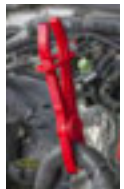
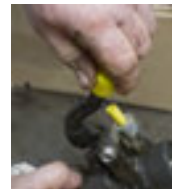

18700 HOT SLEEVE

Protects Arms from Burns While Working Around the Engine.

Made of durable, heat-resistant Kevlar®. Double wall construction for added heat protection. Will protect hand and forearm from hot objects. Will work on either right or left arm. Sleeve is washable.

18700 Hot Sleeve. Hang Card. Bagged. Shipping wt. 3 oz.

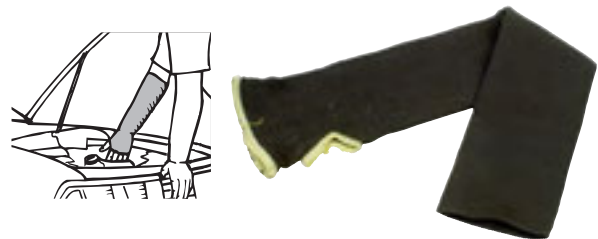

21260 ARM GLOVE

Total Hand and Arm Burn Protection.

The heat resistant Kevlar® material protects hands and arms from hot surfaces. This enables work on hot engines and exhaust systems without waiting. Works on both right and left hands. The glove portion is coated with a vinyl tread for greater gripping power. Extends to 24". Washable.

21260 Arm Glove. Hang Card. Bagged. Shipping wt. 37 oz.



45900 HOOD PROP

Works on All Makes of Cars and Trucks.

The three-piece, telescoping design allows the mechanic to hold the hood in the desired position. The tool telescopes from 18-1/2" to 46-3/4". Can be used from the side of car for better access to the engine compartment. Also great for body or repair work on door, trunk lids, or hatchbacks.

45900 Hood Prop. Skin-packed. Shipping wt. 2 lbs. 3 oz.



46170 HOOD PROP WITH SUPPORT

Includes a Support to Help Prevent Slipping.

The tool includes our standard 45900 Hood Prop plus a support to help prevent the bottom of the tool from slipping. The tool with the support telescopes from 20" to 48-1/4". Place the support over a hood adjuster. Then set the hood prop base into the holding support.

46170 Hood Prop. Skin-packed. Shipping wt. 2 lbs. 4 oz.

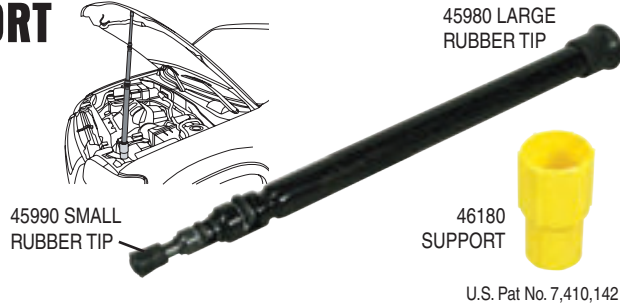

44870 UNIVERSAL LIFT SUPPORT CLAMP

Holds Weak Gas Charged Lift Supports Open.

Tool holds gas charged lift supports found on hoods, tailgates, hatchbacks and trunks. Clamp securely holds weak lift supports in the extended position to allow access to the engine compartment or luggage area. The aluminum body and brass threads prevent damage to the lift support. Colorful flag serves as a reminder to remove the clamp.

44870 Universal Lift Support Clamp. Skin-packed. Shipping wt. 4 oz.

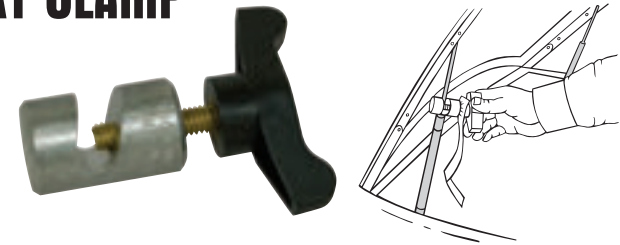

59800 SERPENTINE BELT TOOL

Releases Tension on Serpentine Belts With a Spring Loaded Idler Pulley.

This tool is used to remove and install belts on serpentine belt systems using the spring loaded idler pulley. For applications with limited access, 13mm and 16mm sockets are built into the handle. This tool covers most domestic and some import applications. Comes with extension for hard-to-reach idler pulleys. Eight low profile sockets and extension help to fit into tight spots. Includes 19mm socket for Honda and Toyota applications.

59800 Serpentine Belt Tool. Skin-packed. Shipping wt. 2 lbs. 4 oz.

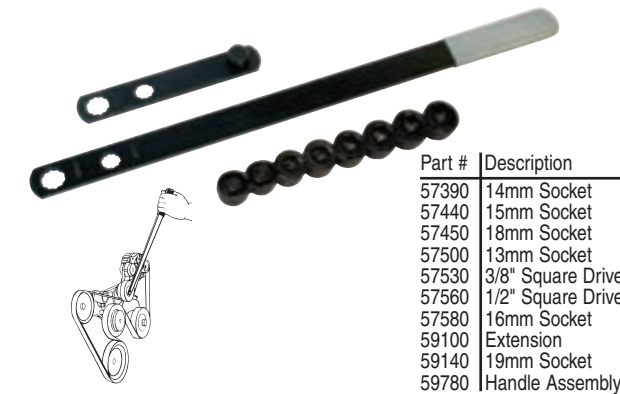

59000 RATCHETING SERPENTINE BELT TOOL

Releases Tension on Serpentine Belts With a Spring Loaded Idler Pulley.

Ratcheting head with freewheel position allows maximum leverage. Set ratcheting head to the middle or neutral/freewheel position and once maximum travel point is reached simply click lever into place to lock the ratchet mechanism. Comes with extension for hard-to-reach idler pulleys. This tool will work where conventional ratchets or breaker bars won't fit due to limited access. Includes 19mm socket for Honda and Toyota applications.

59000 Ratcheting Serpentine Belt Tool. Skin-packed. Shipping wt. 2 lbs. 10 oz.



70500 TAP SOCKET SET

For Use in Restricted Areas.

Ideal for use in areas where a T-handle won't fit. Set of 8 sockets fits all number and fractional M.C.T.I. standard taps thru 1/2". Also fits 1/8" NPT taps and metric taps thru 12mm manufactured to M.C.T.I. standards. Convenient vinyl holder. All sockets are available individually.

70500 Tap Socket Set. Skin-packed. Shipping wt. 15 oz.



70500 SET INCLUDES:

Part No.		Fits In.	Fits Metric	Shank Dia.	Sq. Size
70520	Socket #1	#1,2,3,4,6,8	1.6, 1.8, 2, 2.2, 2.5, 3, 3.15, 3.5mm	.141	.110
70540	Socket #2	#8	4mm	.168	.131
70560	Socket #3	#10	4.5, 5mm	.194	.152
70580	Socket #4	1/4"	6, 6.3mm	.255	.191
70600	Socket #5	5/16", 7/16"	7, 8mm	.323	.242
70620	Socket #6	3/8"	10mm	.381	.286
70640	Socket #7	1/2"	12, 12.5mm	.367	.275
70660	Socket #8	1/8" NPT		.437	.328

70940 TAP SOCKET SET

Three Larger Sizes in a Convenient Set.

Ideal for use where a T-handle won't fit, especially in restricted areas. For larger, fractional M.C.T.I. standard taps. #9 socket is 5/8" (16mm), #10 is for 11/16" (18mm) and #11 is for 3/4". Convenient vinyl holder. All sockets are available individually.

70940 Tap Socket Set. Skin-packed. Shipping wt. 1 lb. 4 oz..

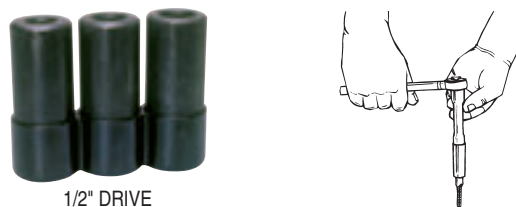

70940 SET INCLUDES:

Part No.		Fits In.	Fits Metric	Shank Dia.	Sq. Size
70860	Socket #9	5/8"	16mm	.480	.360
70880	Socket #10	11/16"	18mm	.542	.406
70900	Socket #11	3/4"	-----	.590	.442

48700 THROTTLE PEDAL DEPRESSOR

Holds Throttle at a Constant RPM.

Engage the nylon hook under the steering wheel. Then extend the depressor rod to the accelerator pedal. Use the adjustment screw to fine-tune the RPM level. Tool is 40" in overall length but can be disconnected for easier storage.

48700 Throttle Pedal Depressor. Skin-packed. Shipping wt. 1 lb. 7 oz.

48770 Replacement Rubber Tip

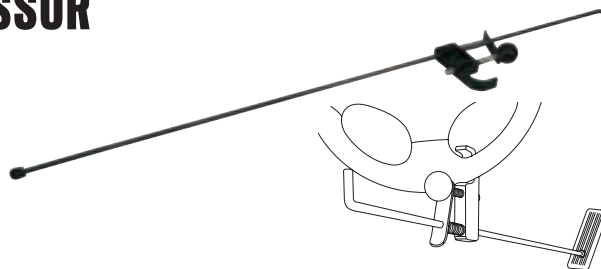

11770 RADIO REMOVER

Disengages Retaining Clips on Fords and Imports.

Tool quickly releases and locks into retaining clips on radios. Also works on some Saab, VW, Audi, and other import applications. Set also serves as handles for removing the radio from the panel. Also works on some DIN mountings found on import vehicles.

11770 Radio Remover. Skin-packed. Shipping wt. 1 oz.

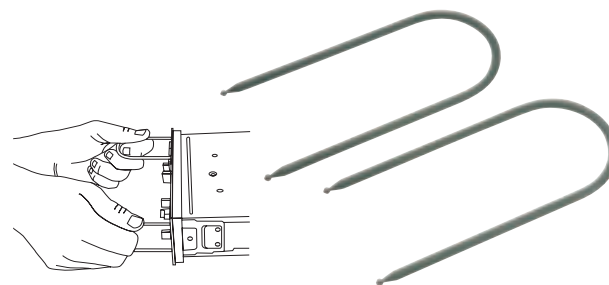

11750 CLUTCH COUPLING REMOVER FOR FORD

Disconnects Ford Hydraulic Clutch Lines.

Easily disengages the hydraulic clutch line from the clutch slave cylinder on some Ford manual transmissions. Tool prongs fit around clutch line above nylon sleeve.

11750 Clutch Coupling Remover for Ford. Skin-packed. Shipping wt. 2 oz.

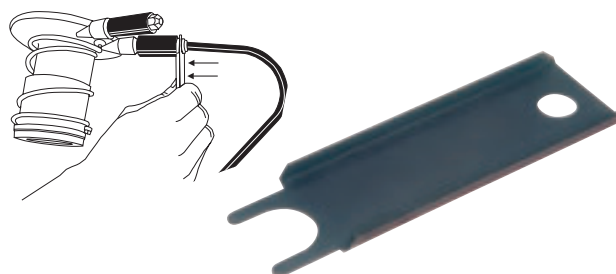

30280 AUTOMATIC CENTER PUNCH

Automatic Firing Action.

Automatic action fires to create a dimple when downward pressure is applied. No hammer is needed. Works on metal, plastic, wood and other materials. Pressure can be varied by turning the knurled knob. Hardened tool steel tip is replaceable. Length 5-1/2".

30280 Automatic Center Punch. Skin-packed. Shipping wt. 2 oz.

30290 Replacement Tip



31840 "O" RING AND SEAL PICK

Quickly Removes & Installs "O" Rings & Seals.

Tips are angled for hard-to-reach areas typically found around brakes, air conditioning and transmissions. Tips are hardened to stay sharp. Handle is knurled for a sure grip.

31840 "O" Ring and Seal Pick. Skin-packed. Shipping wt. 2 oz.

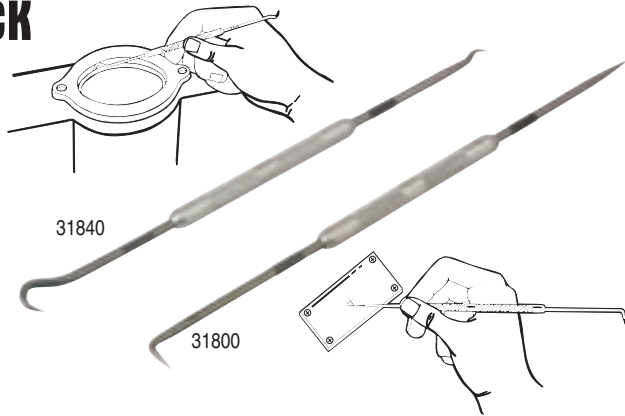

31800 SCRIBE

For Marking Metal & Softer Material Surfaces.

Comes with straight and 90° points to mark in even the tightest places. Heat-treated carbon steel points provide durability. Knurled aluminum handle provides a sure grip.

31800 Scribe. Skin-packed. Shipping wt. 2 oz.

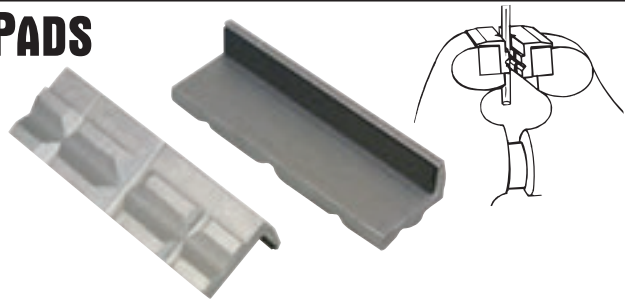

48000 ALUMINUM VISE JAW PADS

Ideal for Holding Round and Hex Parts Securely.

V-shaped aluminum surface holds and helps protect round or hex parts. Specially designed ledge supports flat parts while clamping. Strong nitrile magnets will attach to any steel vise jaws. Pad length is 4".

48000 Aluminum Vise Jaw Pads. Skin-packed. Shipping wt. 7 oz.

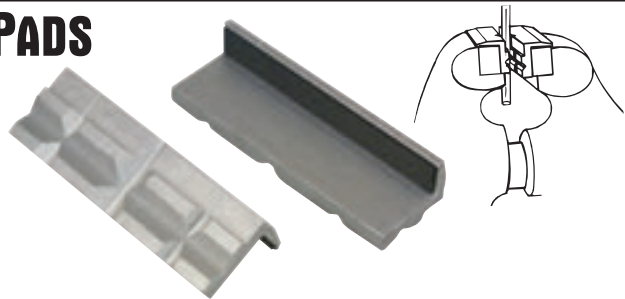

48100 RUBBER FACED VISE JAW PADS

For Protecting Delicate Parts.

Rubber jaw pads protect delicate parts from damage. Also works great for holding irregular shapes. Strong nitrile magnets attach to any steel vise jaw. Pad length is 4".

48100 Rubber Faced Vise Jaw Pads. Skin-packed. Shipping wt. 7 oz.

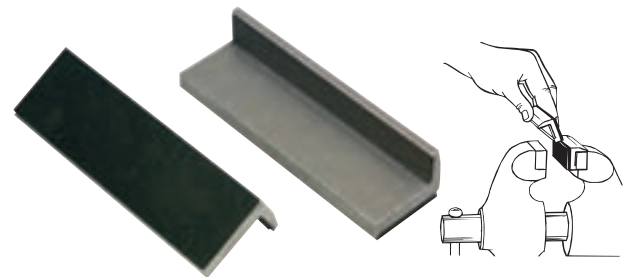

12050 12060 MASTER CHUCK KEYS

Two Handy Chuck Keys, Each with 4 Sizes.

Both tools have strong neodymium magnets for attachment close to the worksite or toolbox. The eight different chuck key sizes cover the most popular chucks available. Cast from alloy steel for strength.

12050 Small Chuck Key. Skin-packed. Shipping wt. 4 oz.

12060 Large Chuck Key. Skin-packed. Shipping wt. 8 oz.

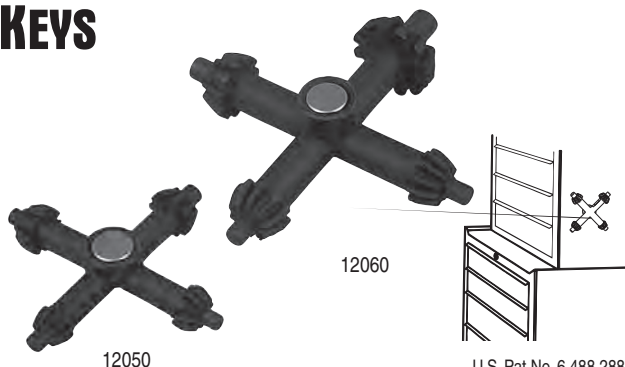

U.S. Pat No. 6,488,288

35900 LED FLEXIBLE FLASHLIGHT

LED Bulb Lasts For Up to 100,000 Hours.

Flexible wire works around obstructions and holds the shape you give it. White light brightly illuminates even the tightest work areas. Uses 3 AAA batteries not included.

35900 LED Flexible Flashlight. Skin-packed. Shipping wt. 2 oz.

35910 Replacement Bulb Assembly

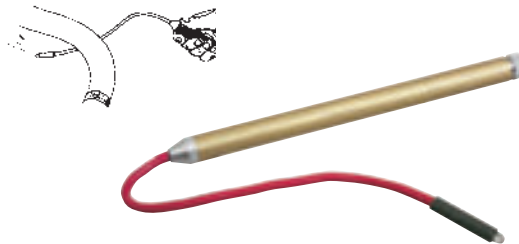

70440 FLEXIBLE HOLDER WITH MAGNETIC BASE

The Flexible, Magnetic Holder Allows Light to be Conveniently Located.

It has a powerful 2" diameter, 50 lb. magnet built-in and is 7-3/4" in overall length. The flexible joints bend up to nearly 90 degrees in any direction. This holder will hold a variety of flashlight diameters.

70440 Flexible Holder with Magnetic Base. Mini Pouch. Shipping wt. 5 oz.

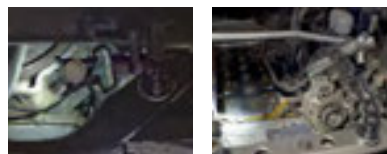

PEGBOARD BARS

Create a Custom Display.

Display bars fit into pegboard gondola displays or pegboard wall for universal application. Bars are 45" long to fill the pegboard area of a 4' gondola. Available in 1", 3", 6", 9" and 12" Sizes. Bars can be waterfalled to save pegboard space.

48890 1" Bar. Shipping wt. 2 lbs. 8 oz.

48900 3" Bar. Shipping wt. 3 lbs.

48910 6" Bar. Shipping wt. 3 lbs. 4 oz.

48920 9" Bar. Shipping wt. 3 lbs. 8 oz.

48930 12" Bar. Shipping wt. 3 lbs. 14 oz.

47540 Bag of 30 Bar Hooks. Shipping wt. 1 lb. 8 oz.



48160 STOCKING TAGS

Handy Tags to Create Your Own Plan-a-Gram.

Universal tags help keep track of your specialty tool inventory and prompt you to reorder out of stock items. Tags can be used to add new tools that are not yet available on our displays. Available in convenient pads of 100 tags with pre-drilled holes to fit pegboard hooks. Stocking tags are free.

48160 Stocking Tags. 100 per pad.



57160 SWIVEL-GRIPPER™ 9 PACK

A Handy Merchandiser that Comes with Nine Swivel-Gripper "No-Slip" Filter Wrenches.

Allows users to feel the texture coating on the inside of the wrench band. Individual Swivel-Gripper filter wrenches can be ordered to refill the display as needed. All four wrench sizes are included.

57160 Swivel Gripper 9 Pack. Boxed. Shipping wt. 6 lbs. 3 oz.



Contents:

- 2 - 57010 Import "No Slip" Filter Wrench 2.375" - 2.625" (60.3 - 66.7MM)
- 2 - 57020 Small "No Slip" Filter Wrench 2.875" - 3.25" (73 - 82.5MM)
- 3 - 57030 Standard "No Slip" Filter Wrench 3.5" - 3.875" (88.9 - 98.4MM)
- 2 - 57040 Large "No Slip" Filter Wrench 4.125" - 4.5" (104.7 - 114.3MM)

47120 ROTARY WATERFALL DISPLAY

Feature Even More Tools in a Compact Space. Holds Over 170 Tools.

The compact, four sided display takes up less than 1 square yard of floor space while offering maximum card and tool exposure. Comes complete with hooks, plan-o-gram label strips, color-coded tool finder, and easy set-up instructions. The display is mounted on rollers for easy movement. A real money maker...increases impulse sales. The display rack is free. You buy only the tools. Also, drop-shipped and freight prepaid.

47120 Rotary Waterfall Display with Tool Assortment. Shipping wt. 231 lbs.

47130 Rotary Waterfall Display Only. Shipping wt. 119 lbs.



62" HIGH

31" WIDE

47600 LARGE GONDOLA DISPLAY

Use your Existing Gondola Space to Merchandise our Most Popular Specialty Tools.

Feature over 145 tools in only 96" x 45". Display bars are compatible with most standard 4' high gondolas with 4' wide sections. The bars hang from the gondola pegboard. If your display area is taller, simply adjust the bars upward. Comes complete with 1" x 45" bars (2 sets of 7) with hooks, plan-o-gram label strips, tool finder, and header sign. The display is free, you buy only the tools. Also, drop-shipped and freight prepaid.

47600 Gondola Display and Tool Assortment. Shipping wt. 178 lbs.

47620 Gondola Display Only. Shipping wt. 68 lbs.



46" HIGH

12" DEEP

96" WIDE

GONDOLA NOT INCLUDED

47500 GONDOLA DISPLAY

Display over 75 Tools, in only Four Feet of Valuable Gondola Space.

Display bars fit most standard 4' high gondolas with a 4' wide section. The bars hang from the gondola pegboard. Bars easily adjust to fit taller display areas. Comes complete with 1" x 45" bars (1 set of 7), plan-o-gram label strips, tool finder, easy set-up instructions, and header sign. The display is free, you buy only the tools. Also, drop-shipped and freight prepaid.

47500 Gondola Display and Tool Assortment. Shipping wt. 79 lbs.

47520 Gondola Display Only. Shipping wt. 34 lbs.

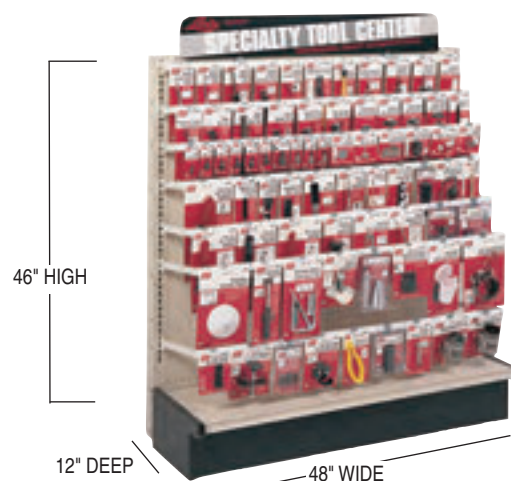

46" HIGH

12" DEEP

48" WIDE

GONDOLA NOT INCLUDED

**92102 93102 93202 93602
94102 97102 99102 LOW
PROFILE PLASTIC CREEPERS**

The Best Plastic Creeper on the Market.

This body-fitting design was developed through testing on many body types to provide optimum comfort. Creeper body is 2" longer for a better fit. Urethane rollers are inserted into steel bushings which are molded into the creeper body. Provides added strength and easy roller replacement. Low profile, 7/8" floor clearance. Easy to clean surface is resistant to solvents, greases and fuels. Dimensions: Length 38", Width 17-1/2", Height 4".

- 92102 Red Plastic Creeper. Boxed. Shipping wt. 11 lbs. 8 oz.
- 93102 Yellow Plastic Creeper. Boxed. Shipping wt. 11 lbs. 8 oz.
- 94102 Blue Plastic Creeper. Boxed. Shipping wt. 11 lbs. 8 oz.
- 97102 Black Plastic Creeper. Boxed. Shipping wt. 11 lbs. 8 oz.
- 93202 Orange Plastic Creeper. Boxed. Shipping wt. 11 lbs. 8 oz.
- 99102 Green Plastic Creeper. Boxed. Shipping wt. 11 lbs. 8 oz.
- 93602 Pink Plastic Creeper. Boxed. Shipping wt. 11 lbs. 8 oz.
- 92132 2" Pop-in Wheel for Plastic Creeper
- 96412 Headrest

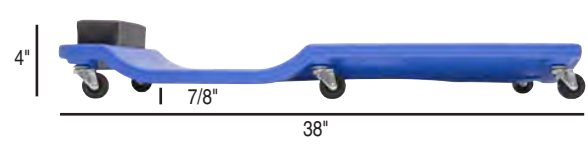

92032 93032 94032 LARGE WHEEL CREEPERS

Bigger Wheels for a Better Ride.

Our popular plastic creepers are now available with larger, 4" pop-in urethane wheels. The larger wheels provide a much smoother ride on cracked or uneven floor surfaces, over floor debris and under heavy loads. Also rolls better on regular floor surfaces. The creeper body is the same as our low profile plastic creeper models 92102, 93102 and 94102.

92032 Large Wheel Plastic Creeper, Red. Boxed. Shipping wt. 14 lbs. 8 oz.

93032 Large Wheel Plastic Creeper, Yellow. Boxed. Shipping wt. 14 lbs. 8 oz.

94032 Large Wheel Plastic Creeper, Blue. Boxed. Shipping wt. 14 lbs. 8 oz.

96572 4" Pop-in Wheel

96412 Headrest



Dimensions: length 38", width 17-1/2", height 8-5/8", floor clearance 3-3/4".

NOTE: You can interchange or retrofit your conventional Lisle plastic creeper with six 96572 4" rollers.

U.S. Pat No. 6,345,828

95002 FOLD UP CREEPER

The Padded Vinyl Creeper Adds Comfort and Protection on the Job.

Works great on off road situations and under a vehicle where no jacks or lifts are used. Folds up and hangs for convenient storage.

95002 Fold Up Creeper. Boxed. Shipping wt. 2 lbs. 15 oz.



Dimensions:
Unfolded 18" x 48",
Folded 18" x 24".

REPLACEMENT ROLLERS AND WHEELS

The 99702 3" steel rollers or 99802 2-3/4" engineering plastic rollers are utilized on our wooden creepers. As an option you can replace these rollers with our 97112 2" wheel with bracket. Both provide a lower profile effect. The 96132 2" oil resistant plastic wheel is standard on all Lisle steel creepers. This low-profile wheel comes with a cap nut and lock washer to prevent loosening. The 92132 2" Pop-in Wheel is standard on our new style plastic creepers. The 96572 Larger 4" wheel for plastic creepers works especially well on cracked or uneven floor surfaces. The 96422 2" oil resistant plastic wheel was standard on all plastic creepers before late 1998. The 96422 wheel includes a cap nut 96552.

92132 2" Pop-in Wheel for Plastic Creepers. Shipping wt. 6 oz.

96132 Wheel for Steel Creepers. Shipping wt. 6 oz.

96142 Cap Nut for 96132. Shipping wt. 1 oz.

96422 Wheel for Plastic Creepers. Shipping wt. 6 oz.

96552 Cap Nut for 96422. Shipping wt. 1 oz.

96572 Large Creeper Wheels. Shipping wt. 1 lb.

97112 Wheel with Bracket for Wood Creepers. Shipping wt. 6 oz.

99702 3" Steel Roller for Wooden Creepers. Shipping wt. 9 oz.

99802 2-3/4" Engineering Plastic Roller for Wood Creepers. Shipping wt. 5 oz.

96132 REPLACEMENT WHEELS FOR LOW PROFILE STEEL CREEPERS

Includes cap nut.
Specifications:
Wheel, 2" dia.
Overall Height, 2-1/2"



96422 REPLACEMENT WHEELS FOR LOW PROFILE PLASTIC CREEPERS

Includes cap nut.
Specifications:
Wheel, 2" dia.
Overall Height, 2-1/2"



For older style plastic creepers, 96402, 96502, 96602, 96702 & 96802.

99802 ENGINEERING PLASTIC ROLLER

Specifications:
Bracket, -
1-9/16" x 2-1/4"
Roller, 2-3/4" dia.
Overall Height, 2-3/4"



99702 ROLLER

Specifications:
Bracket, 1-1/2" x 2"
Overall Height, 3"



92132 POP-IN WHEEL FOR PLASTIC CREEPERS

Specifications:
Wheel, 2" dia.
Overall Height, 2-3/4"



For all plastic models.

For models 92032 93032 94032 or retrofit models 92102, 93102 & 94102.



96572 LARGE POP-IN WHEEL FOR PLASTIC CREEPERS

Specifications:
Wheel, 4" dia.
Overall Height, 4-3/4"

19342 MULTI-APPLICATION OIL FUNNEL

Helps Eliminate Oil Spills when Refilling Crankcases, Especially Those with Baffle Valve Covers.

The 1.6 qt. translucent funnel comes with seven different color-coded adapters and a 45°elbow to work on many applications and save valuable storage space. Use spout only as a standard funnel. The adapters fit crankcases securely. Tethered lid and cap keep the funnel clean.

19342 Multi-Application Oil Funnel. Color Label. Shipping wt. 12 oz.	
19352 GM/Ford Adapt, Black	19362 Ford/Mazda Adapt, Blue
19372 Toyota/Lexus Adapt, Yellow	19382 Honda/Acura/Nissan Adapt, Green
19392 VW/Audi Adapt, Maroon	19402 Chrysler Adapt, Purple
19412 Toyota/Lexus Adapt, Orange	19422 Straight Adapt, Clear
19432 Elbow 45°	19442 Lid, Red
19532 Tethered Cap, Red	19682 Ring Adapt, Black



17252 TRANSAXLE FUNNEL WITH EXTENSION

1.6 Qt. Translucent Funnel with 18" Clear Spout to Work On Hard-To-Reach Automatic Transmission Fill Plugs.

The nozzle adapter can be used on vehicles without fill plugs by removing the speed sensor. Nozzle adapter can also be used to fill through dipstick tubes. Works great on Hondas. May also work on other applications. Tethered lid and spout cap keep funnel clean and help prevent messes.

17252 Transaxle Funnel with Extension. Box w/ Label. Shipping wt. 1 lbs. 1 oz.	
17262 Lower Tube Extension	
17272 Upper Tube Extension	
18252 Nozzle	
18832 Funnel Body	
19682 Tethered Lid, Black	
19692 Spout Cap, Black	
19422 Straight Adapter Clear	



18232 OFFSET FUNNEL WITH SPOUT CAP AND LID

17232 RIGHT ANGLE FUNNEL

10" Tall Translucent Funnel with a 6-3/4" Offset from Center of Mouth to Center of Spout for Hard-to-Reach Applications.

Useful for adding brake fluid to master cylinders on mini-vans, adding gear lube to differentials, filling the DEF reservoir on GM Duramax diesels as well as other applications.

18232 Offset Funnel with Spout Cap and Lid. Color Label. Shipping wt. 8 oz.

17232 Right Angle Funnel. Color Label. Shipping wt. 4 oz.

17242 Retro Upgrade Kit for 17232

18242 Lid, Black

18252 Nozzle

19692 Spout Cap, Black



19802 THREADED OIL/TRANSMISSION FUNNEL

Hands-Free Filling on Threaded Valve Cover Openings.

Two-piece design can be used separately or threaded together for a long super funnel. The larger section screws into threaded oil filler openings, found on many Ford pickups and Dodge, Jeep & Chrysler cars, mini vans & SUVs. This holds the funnel upright for quick, mess free oil fills. Also works on some Honda, Acura and Nissan vehicles. The diameter of the smaller funnel is narrow enough to fit even the smallest applications including transmission filler holes.

19802 Threaded Oil/Transmission Funnel. Shipping wt. 4 oz.



19832 1.6 QT. PLASTIC FUNNEL WITH LID & SPOUT CAP

Handy 1.6 qt. Polypropylene Funnel has a Removable 9" Flexible Spout and Narrow Design for Hard-to-Reach Applications.

Includes a lid and spout cap to keep contaminants out. A 4" opening for the lid creates a lip to prevent excess fluid from dripping out of the top when the funnel is laid down after use. Translucent material allows the technician to see the fluid inside the funnel.

19832 1.6 qt. Plastic Funnel w/Lid & Spout Cap. Color Label. Shipping wt. 7 oz.

19682 Lid

19692 Spout Cap

19742 White Spout & Threaded Collar

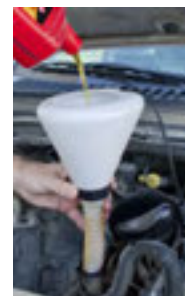

11102 8 GALLON OIL LIFT DRAIN

Quick Release Height Adjustment.

This specially shaped, translucent jug holds 8 gallons. Reinforced base will not warp with hot oil. Has a wide working range from 36-1/2" to 74". Its lower center of gravity increases stability and four 2-1/2" ball bearing wheels swivel and roll easily. Also has a heavy-duty adjustment clamp, large handle and big pour spout with threaded cap. Large 15" funnel has strainer built-in to catch drain plugs.

11102 8 Gallon Oil Lift Drain. Boxed. Shipping wt. 16 lbs.	
11052 Spout Cap	11302 Funnel
11402 Top Tube, Plated	11502 Bottom Tube, Black
11512 Tube Lock Ring	11602 Wheel Assembly
11702 Tube Clamp	

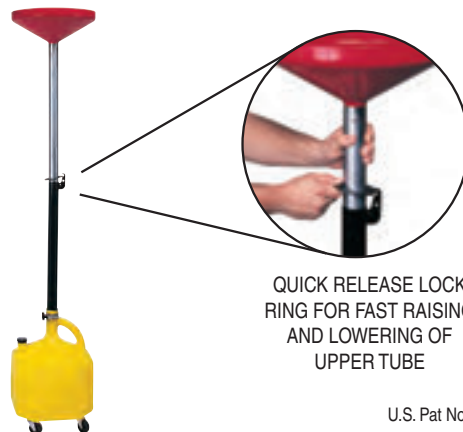

QUICK RELEASE LOCK RING FOR FAST RAISING AND LOWERING OF UPPER TUBE

U.S. Pat No. 6,367,586
D429,160

17432 18 GALLON OIL LIFT DRAIN

Quick Release Height Adjustment.

Translucent jug holds 18 gallons and will not warp with hot oil. Rolls easily with four heavy-duty 2-1/2" wheels. Metal tubes extend working area from 36-1/2" to 77". Drains from the bottom with a brass drain valve. Large 15" funnel has a built in strainer to catch drain plugs.

17432 18 Gallon Oil Lift Drain. Boxed. Shipping wt. 21 lbs.	
11302 Funnel	11402 Top Tube, Plated
11502 Bottom Tube, Black	11512 Tube Lock Ring
11512 Tube Lock Ring	17382 Wheel
17402 Cap	17812 Brass Ball Valve

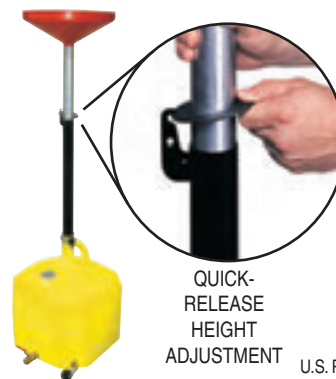

QUICK-RELEASE HEIGHT ADJUSTMENT

U.S. Pat No. 6,367,586
D429,160

17892 17902 TRANSMISSION DRAIN FUNNELS

Heavy-duty plastic lift drain funnels extend the catch area of any lift drain. The funnel catches any loose parts. Flexible, if run over it will return to its original shape. Super Transmission Drain Funnel fits the Ford E 40D and others. The fluted design can be used for draining oil filters. 17892 dimensions, 22" x 23". 17902 extra large size, 24" x 36".

17892 Transmission Drain Funnel. 12 per Master Pack. Shipping wt. 17 lbs. 4 oz.
17902 Super Transmission Drain Funnel. 6 per Master Pack. Wt. 28 lbs. 8 oz.

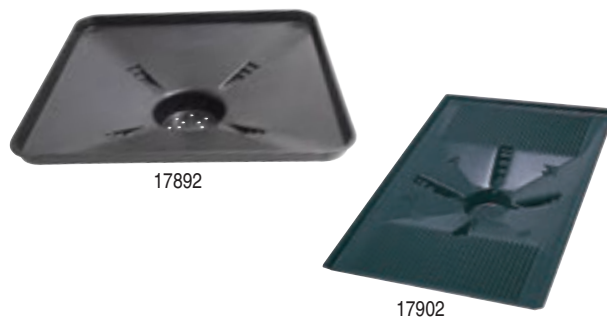

17892

17902

38750 38780 NO SPLATTER PAD

15" Diameter Pad & 22" Square Pad Protects Floors & Work Area from Messy Oil Splatter.

Insert 15" diameter pad in funnel or oil pan before oil change, or insert 22" square pad in transmission drain funnels or larger oil drain pans, before oil change to eliminate oil splatter. Porous material allows fluid to quickly pass through into funnel or pan. Pad material resists engine oil, transmission fluid, coolant, brake fluid, brake cleaner, gear oil and other solvents. 15" fits all standard oil lift drain funnels and oil pans. 22" fits all standard transmission drain funnels and larger size drain pans. Pad can be trimmed for perfect fit. Important: Not for coolants or fluids that will be recycled in the vehicle. Material fibers may contaminate the fluid.

38750 15" No Splatter Pad. 8 per Master Pack. Shipping wt. 8 oz.
38780 22" No Splatter Pad. 6 per Master Pack. Shipping wt. 1 lb. 6 oz.

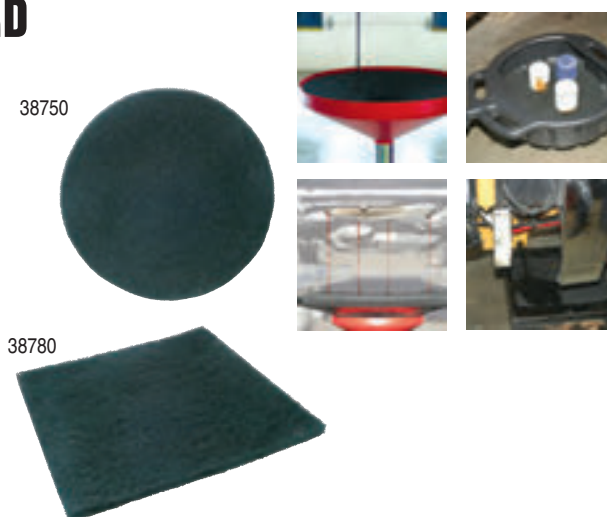

38750

38780

19732 19752 6 QUART OIL DISPENSERS

Translucent (see through) polyethylene material enables the user to read the liquid level on the container. Marked in both quarts and liters. The flexible 8" pouring spout enables easy transfer of liquid. The 19732 spout is white. The 19752 spout is red.

19732 6 Quart Oil Dispenser, White Spout. 6 per Master Pack. Shipping wt. 6 lbs. 14 oz.

19752 6 Quart Oil Dispenser, Red Spout. 6 per Master Pack. Shipping wt. 6 lbs. 14 oz.

19742 White Spout & Threaded Collar **19762 Red Spout & Threaded Collar**

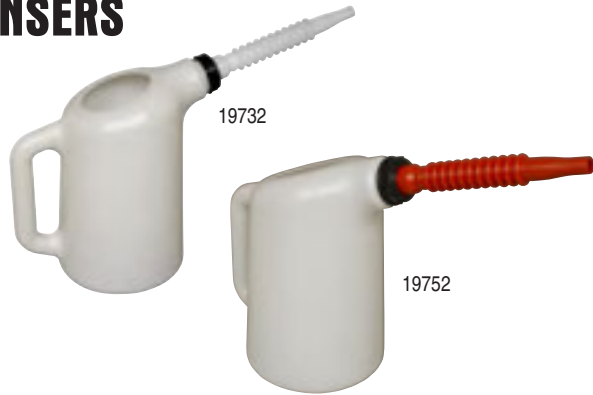

19702 8 QT. OIL DISPENSER WITH LID

An Even Larger Size for Trucks, SUVs and Other Engines with Greater Oil Capacity.

A larger version of the 6 qt. Oil Dispenser with flexible pouring spout. Many large SUVs and trucks now require more than 6 quarts of oil. Translucent polyethylene material enables the user to read the oil level on the container up to 8 quarts. Marked in both quarts and liters. Flexible, removable 8" pouring spout. Lid may not fit older 19712 Dispensers.

19702 8 qt. Oil Dispenser. 4 per Master Pack. Shipping wt. 7 lbs. 8 oz.

19742 White Spout & Threaded Collar **19682 Lid**

19692 Spout Cap



17912 55 GALLON DRUM DRAIN FUNNEL

Designed to Transfer Liquids into a 55 Gallon Drum.

The funnel drain sits on the top cover of 55 gallon drums. The funnel snout fits into the top bung hole for draining purposes. Four graduated circular indentations fit different oil filter sizes.

17912 55 Gallon Drum Drain Funnel. 8 per Master Pack.

Shipping wt. 24 lbs. 12 oz.



19722 CATCH-ALL DRIP PAN

Ideal for Use on Showroom Floors, Garages, Carports, or Under Equipment.

Made of durable polyethylene material to assure longevity and flexibility. Holds 8 quarts. Dimensions are 24" x 36" x 1-1/2".

19722 Catch-All Drip Pan. 12 per Master Pack. Shipping wt. 27 lbs.



19772 1 QUART SPRAY BOTTLE

Industrial Sprayer for Use with Light Oils, Solvents and Detergents.

The durable polyethylene bottle is impervious to high and low temperatures. The trigger mechanism is resistant to damage caused by caustic materials.

19772 1 Quart Spray Bottle. 1 per Pack. Shipping wt. 4 oz.

32 per Master Pack. Shipping wt. 10 lbs. 15 oz.



17942 17952 4.5 GAL. PAN

For easy transfer of liquids. High-density polyethylene material is resistant to chemicals and solvents, and is easy to clean.

1" wide diameter spout for quick and easy pouring. The anti-splash lip and baffles help prevent spilling when carrying or pouring. Comes with large, easy-grip handles. Two colors: 17942 is black for oil and 17952 is green for anti-freeze.

17942 4.5 Gallon Oil Drain Pan, Black. 8 per Master Pack. Ship wt. 21 lbs.

17952 4.5 Gallon Oil Drain Pan, Green. 8 per Master Pack. Ship wt. 21 lbs.



17942



17952

17922 MULTI-DRAIN TUB

30 Quart, Heavy-Duty, All-Purpose Plastic Drain Tub.

For draining radiators, crankcases, transmissions, differentials, etc. on cars and trucks. Designed for easy pouring and disposal. The apron facilitates washing and sorting parts. Dimensions 33" x 22" x 8".

17922 Multi-Drain Tub. 6 per Master Pack. Shipping wt. 27 lbs. 12 oz.



17932 6 QUART DRAIN PAN

Plastic Drain Pan with Pour Spout.

The pan is 4" deep, 14" wide to the spout.

17932 6 Quart Drain Pan. 50 per Master Pack. Shipping wt. 29 lbs. 6 oz.



19202 LOW PROFILE TRUCK DRAIN WITH LID

For Large Capacity Crank Cases or Radiator Systems.

Overall height of 7-1/2" to fit under more aerodynamic trucks. The drain holds 60 quarts and is equipped with four rollers and a handle for transport and easy positioning under trucks. Cover and curved side design help keep oil from spilling during movement. Convenient handles and pour spout facilitate oil evacuation.

19202 Truck Drain with Lid. Boxed. Shipping wt. 26 lbs.

19192 Truck Drain Cover

SUPERSEDES 19122



U.S. Pat No. 6,874,549

19822 TIRE / TUBE TEST TANK

A durable plastic tank for testing tubes and tires. The tank features reinforcement ribs for extra support. Will handle passenger tire sizes to wide oval and light duty truck tires. Inside dimensions 31" x 12" x 12".

19822 Tire / Tube Test Tank. 6 per Master Pack. Shipping wt. 44 lbs. 8 oz.



19852 TRUCK & TRAILER WHEEL PAN

Catches Oil from Wheel Hubs After Removing Cap.

Prevents oil mess during wheel repair. The pan fits rims with 13-3/4" ID and larger. Handle compartments hold hub nuts out of the oil. Made of polypropylene for durability. Will not warp if oil is warm. Capacity 88 ounces.

19852 Truck & Trailer Wheel Pan. 8 per Master Pack. Shipping wt. 5 lbs. 12 oz.



U.S. Pat No. 6,454,121

13950 WHEEL STUD PILOT PIN SET

Easily Remove and Install Wheels on Many European Vehicles with Lug Bolts.

Three pairs of metric threaded wheel stud pilot pins allow you to hang the wheel without having to balance the wheel on the small lip of the hub. This helps prevent the wheel from falling and causing damage or injury. Simply insert threaded pins into hub bolt holes to hold the wheel in place while inserting or removing lugs. Set includes 12mm x 1.5, 14mm x 1.25 and 14mm x 1.5 threaded pins. Also available individually.

13950 Wheel Stud Pilot Pin Set. Skin packed. Shipping wt. 1 lb. 11 oz.

13920 12mm x 1.5 Wheel Stud Pilot Pins

13930 14mm x 1.5 Wheel Stud Pilot Pins

13940 14mm x 1.25 Wheel Stud Pilot Pins



12mm x 1.5 fits:	BMW, VW, Mercedes, Porsche, and Mini Cooper.
14mm x 1.25 fits:	2009 and newer BMW 6 series, 7 series, X3, X5, X6 and Mini Cooper.
14mm x 1.5 fits:	VW, Mercedes, Porsche, BMW and Audi.

13970 12MM X 1.25 WHEEL STUD PILOT PINS

Easily Remove and Install Wheels on Fiat 500 and Dodge Dart Cars with Lug Bolts.

Wheel stud pilot pins allow you to hang the wheel without having to balance the wheel on the small lip of the hub. This helps prevent the wheel from falling and causing damage or injury. Simply insert threaded pins into hub bolt holes to hold the wheel in place while inserting or removing lugs. Works on 2013 and newer Dodge Dart and 2012 and newer Fiat 500 cars with 12mm x 1.25 metric lug bolts.

13970 12mmx1.25 Wheel Stud Pins. Skin packed. Shipping wt. 8 oz.



22800 WHEEL STUD INSTALLER

Easily Installs New Wheel Studs.

Use with a ratchet or impact wrench to pull the new stud securely in place. Position the tool over the stud shaft. Tighten the lug nut against the tool to pull the stud in place. Works on most all automotive and light-duty truck wheel studs, foreign and domestic. NOTE: The bearing will wear with use and is not warranted.

22800 Wheel Stud Installer. Clam Shell. Shipping wt. 5 oz.

22820 Replacement Bearing & Dust Shield



U.S. Pat No. 7,421,769

28950 TRUCK WHEEL STUD INSTALLER

Installs Most Truck Wheel Studs in Seconds.

Use with an impact wrench or ratchet. The tool body is equipped with a thrust bearing to easily pull the new wheel stud into place. Fits truck wheel studs up to 22mm (7/8") in diameter. Use the lug nut to tighten against the tool body to pull the stud in position.

28950 Truck Wheel Stud Installer. Clam Shell. Shipping wt. 9 oz.

28970 Replacement Bearing and Dust Shield



U.S. Pat No. 7,421,769

17282 FLUID EXTRACTOR / TRANSFER PUMP

Works for Transferring or Siphoning All Types of Automotive Fluid.

Quickly removes transmission oil from automatic transmissions that are over filled. Also works great for adding oil to differentials. Translucent 1.1 Quart / 1.1 Liter capacity cylinder body is marked in both English and metric. Includes two valves; a shut off valve for transferring fluids and a siphon valve with intake and discharge hoses, ideal for removing coolant. Disassembles for easy cleaning, enabling use with multiple fluids. High quality seals stand up to caustic fluids.

17282 Fluid Extractor / Transfer Pump. Box w/ Label. Shipping wt. 2 lbs. 3 oz.

17292 Replacement Seal Kit (2 Seals)

17302 Plastic Pump

17312 Extractor Adapter and Hose

17322 Transfer Adapter and Hoses



YouTube

68130 WHEEL WEIGHT TOOL

Removes, Trims and Installs Clip-on Wheel Weights.

Tire lever and offset flat tip for removing wheel covers. Use hammer head to pound on wheel weights. Pliers action grabs weights for removal. Also cuts weights. Sturdy vinyl grips provide a good grip.

68130 Wheel Weight Tool. Skin-packed. Shipping wt. 1 lb. 3 oz.

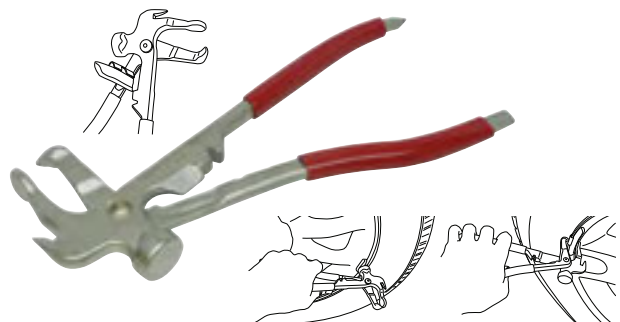

19860 TIRE DEFLATOR SET FOR TPMS VALVE STEMS

Quickly Evacuates Air from Tires Without Removing the Valve Core.

Simply replace a standard sized valve cap with this handy tool and the special design will depress the pin in the valve core. Large openings on the sides of the tool allow air to escape quickly from the tire. Tools are marked so tires can be returned to their original position on the vehicle so TPMS will not need to be reset. Also saves time since the valve core has not been removed from the sensor.

19860 Tire Deflator Set for TPMS Valve Stems. Skin-packed. Shipping wt. 5 oz.

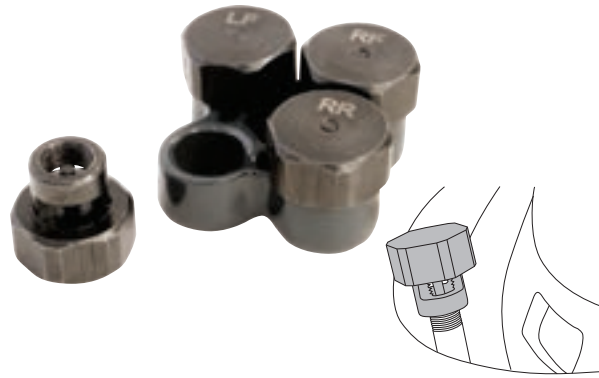

14100 VALVE CORE TOOL

Removes and Installs Valve Cores and Valve Core Caps.

The double ended core driver reverses in the tool body. The reversible driver fits both large and small valve cores. Use the reverse end to remove and install valve core caps. The long tool handle will access inside dual wheels. The lightweight aluminum body is equipped with a pocket clip.

14100 Valve Core Tool. Skin-packed. Shipping weight 1 oz.

14110 Core Driver

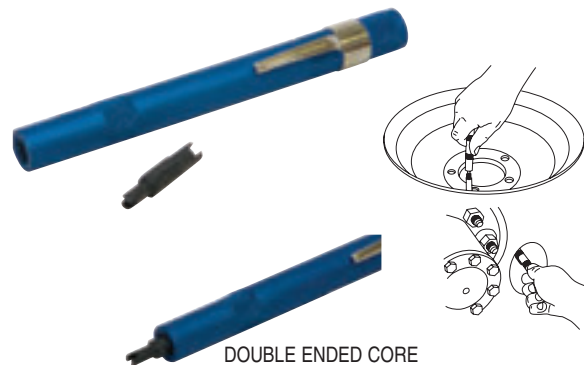

DOUBLE ENDED CORE DRIVER SNAPS INTO BODY

18810 VALVE CORE TORQUE TOOL

Properly Installs and Removes Valve Cores, Including Late Model Vehicles with the Tire Pressure Monitoring System (TPMS).

Torque tool is set to 4 inch pounds, to prevent under and over torquing the valve core. Helps prevent valve core leaks causing low tire pressure and possible TPMS alerts. Slim design allows access in tight spots.

18810 Valve Core Torque Tool. Skin-packed. Shipping wt. 4 oz.

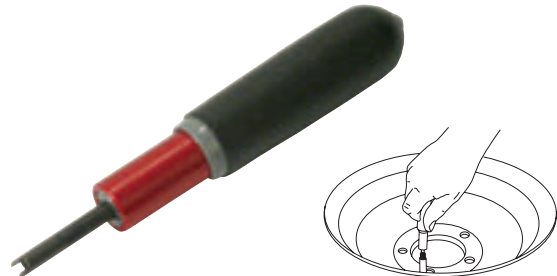

15190 VALVE CORE TOOL

Heat-Treated Steel Tip for Removing and Installing Standard Valve Cores.

A dual durometer handle for comfort with a rotating knob on the end allowing the tool to turn smoothly while applying pressure with the palm of your hand. The 5.7" long tool can reach valve stems on the inner dual wheels. Includes a handy pocket clip.

15190 Valve Core Tool. Skin Packed. Shipping wt. 2 oz.



TURN YOUR TOOL IDEA INTO MONEY

LISLE CORPORATION CURRENTLY PAYS ROYALTIES TO OVER 120 INDIVIDUALS.

If you have an original tool idea which others may need, Lisle Corporation is interested in evaluating your idea. Your idea may be produced and sold by Lisle Corporation under an attractive Award or Royalty Agreement that will bring you an income for years to come. If you have a new tool idea, or have identified a problem, follow these two simple steps:

1. Write Lisle and request an Idea Disclosure Agreement or fill out a request form on our website: www.lislecorp.com/about/program
2. Return the signed agreement to Lisle Corporation. We will promptly evaluate your idea. You will then be notified whether or not we will offer an award or royalty.

I.D.A. Program
Lisle Corporation
807 E. Main Street
PO Box 89
Clarinda, Iowa USA 51632-0089

www.lislecorp.com/about/program



A PROVEN SUCCESS FORMULA!

Lisle Corporation has been in business since 1903 with sales distribution throughout the world. Through the years, we have been a leader in developing and marketing new tools for the automotive service industry. Most of these new tools were developed by our own engineering department...but many successful tools were the ideas of individual mechanics who recognized a problem. Lisle Corporation has been working with submitters of new tool ideas on an award or royalty basis for more than 40 years.



INDIVIDUALS JUST LIKE YOU HAVE DEVELOPED THE FOLLOWING LISLE TOOLS:

55000 MAGNETIC SOLDERING CLAMP

Offers an extra pair of hands when soldering. Alligator clamps firmly hold wire and small parts when soldering. Flexible design allows different ways to attach and hold wire.



56810 RELAY TEST JUMPER KIT

Set of four relay test jumpers make testing relays or live circuits quick and easy. Fits many popular size relays on domestic and import vehicles. Simply remove relay to be tested, insert correct jumper and insert relay into jumper.



57020 SMALL SWIVEL-GRIPPER™

"No-Slip" filter wrench. Tough, Stainless steel band with permanently bonded textured coating for superior gripping power...Won't slip.



65600 BROKEN SPARK PLUG REMOVER FOR FORD TRITON 3 VALVE ENGINES

This tool set removes broken spark plugs from 2004 and newer Triton 3 valve per cylinder engines, (a common problem). The set includes a unique porcelain pusher tool and a tapered left-hand thread remover for removing the broken spark plug without leaving the porcelain in the engine cylinder.



Jason Jantzer
Phoenix, Oregon

Mr. Jantzer's tool ideas (our 43300 Pneumatic Fan Clutch Wrench Set, 36880 Dual Overhead Cam Lock Tool and 18980 Pneumatic U-Joint Driver) are submissions that have been added to the Lisle tool line.

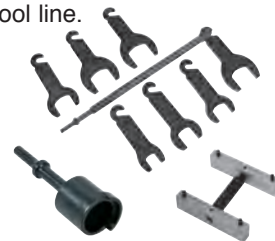

INVENTOR



10000	Brake Hone.....	1	23300	Small Engine Valve Spring Compressor.....	19	40900	1/2" Magnetic Socket Holder Red.....	74	57340	Steering Wheel Lock Plate Tool.....	35
10400	Disc Brake Hone.....	1	23400	Transaxle/Transaxle Plugs.....	26	40990	1/2" Magnetic Socket Holder Green.....	74	57670	Alternator Decoupler Pulley Tool Kit.....	30
10500	Brake Hone.....	1	23500	Stone-Type Glaze Breaker.....	28	41080	45 Degree Trim Clip Pliers.....	58	57830	Wire Terminal Tool Kit.....	63
10900	5/16" x 3/8" Brake Bleeder Wrench.....	6	23800	Flywheel Turner.....	23	41090	90 Degree Trim Clip Pliers.....	58	57780	Terminal Tool for Ford.....	63
10950	1/4" x 3/8" Brake Bleeder Wrench.....	6	24000	Ring Groove Cleaner.....	19	41220	Thick Pickle Fork Kit, 5 Pc.....	9	57850	Battery Carrier.....	62
10990	7mm - 9mm Brake Bleeder Wrench.....	6	24300	Speedy Brake Pad Spreader.....	1	41250	Push Pin Pliers.....	58	58430	Shaft In Seal Puller.....	25
11000	8mm - 10mm Brake Bleeder Wrench.....	6	24400	Disc Brake Pad Spreader.....	1	41400	Stepped Pickle Fork Kit.....	9	58600	Basic Fuel Injection Test Set.....	41
11102	8 Gallon Oil Lift Drain.....	93	24550	Computer Safe Circuit Tester.....	71	41440	Stepped Pickle Fork Kit, 5 Pc.....	9	58850	Oil Pan Plug Rethreading Kit.....	49
11120	Battery Brush.....	62	24680	Spill-Free® Funnel.....	33	41500	Pickle Fork Kit.....	9	59000	Ratcheting Serpentine Belt Tool.....	84
11260	Brake Spring Pliers.....	5	24800	Seal Driver Kit.....	13	41690	2 Jaw Rev. & Adj. 5 Ton Puller.....	31	59250	Molding Remover/Installer.....	58
11400	Side Terminal Battery Cleaner.....	62	25000	Universal Disc Brake Caliper Tool.....	2	41780	Timing Gear Puller.....	34	59370	Stretch Belt Remover/Installer.....	29
11420	Hose Cutter.....	82	25750	Dual Piston Brake Pad Spreader.....	1	41900	Pitman Arm Puller.....	10	59400	Pinion Bearing Race Driver Set.....	13
11550	3 Way Battery Tool.....	62	26000	Tamper Resistant Torx® Bit Set.....	51	41970	Heavy-Duty Pitman Arm Puller.....	10	59600	Deutsch Terminal Tool.....	79
11750	Clutch Coupling Remover for Ford.....	85	26250	Low Circuit Tester.....	70	42150	Standard Hex Key Set.....	52	59800	Serpentine Belt Tool.....	84
11770	Radio Remover.....	85	26280	Master Torx® Socket Sets.....	51	42200	Metric Hex Key Set.....	52	60200	Heavy Duty Strap Filter Wrench.....	48, 77
12000	Magnetic Chuck Key, Small.....	86	26330	LED Continuity Tester.....	71	42260	5 Pc. Air Line Disconnect Set.....	56	60530	Small Fastener Remover.....	54
12060	Magnetic Chuck Key, Large.....	86	26530	Master Tamper Resistant Torx® Bit Set.....	51	42420	30 Degree Push Pin Pliers.....	58	60610	Relay Test Jumper Kit II.....	65
12100	Oxygen Sensor Socket.....	27	26550	9 Pc. Torx® Bit Set.....	50	42430	80 Degree Push Pin Pliers.....	58	60660	Deluxe Relay Test Kit.....	65
12230	Oxygen Sensor Thread Chaser.....	27	26750	External Torx® Socket Set.....	51	42480	Panel Clip Pliers.....	58	60750	12 Point Bit Set.....	53
12390	Dual Drive Oxygen Sensor Wrench.....	27	26900	Spark Plug Wire Tester.....	44	42500	Long Arm Hex Key Set.....	52	60850	Master Triple Square Bit Set.....	53
12550	Brake Caliper Bit Set.....	3	27000	Sneaky Pete.....	29	42650	Long Arm Metric Hex Key Set.....	52	60900	Heater Core Backflush Tool.....	30
12600	Bearing Race and Seal Driver.....	13	27100	Adhesive Heat Shrink Tubing Assortment.....	65	42920	Universal Fan Clutch Wrench Set.....	37	61030	Wire Insertion Tool Set.....	68
12800	Mast. Pneum. Bearing Race & Seal Dvr. Set.....	13	27170	Heat Shrink Tubing Assortment.....	69	43300	Pneumatic Fan Clutch Wrench Set.....	37	61060	Diezel Filter Wrench for Paccar.....	77
12980	Bearing Race and Seal Driver Master Set.....	13	27200	Master Torx® Bit Set 12 Pc.....	50	43340	2-1/8" Fan Clutch Wrench.....	36	61090	5" Diesel Filter Wrench for Davco.....	77
13000	Exhaust Manifold Spreader.....	29	27250	4-WD Wheel Bearing Lock-Nut Tool.....	16	43600	Universal Fan Clutch Wrench Set.....	36	61110	6" Diesel Filter Wrench for Davco.....	77
13120	Electrical Connector Separator.....	68	27400	Combination 4-WD Bearing Wrench.....	16	43620	Ball Jnt. / Truck Brake Anchor Pin / U-Jnt. Press.....	12	61130	8" Diesel Filter Wrench for Davco.....	77
13200	Oil Pressure Switch Socket.....	27	27430	24 Volt Heavy-Duty Circuit Tester.....	70	44000	Tubing Bender.....	81	61400	Straight Hog Ring Pliers.....	57
13250	Oil Pressure Switch Socket.....	27	27490	E-4 Torx® Socket.....	50	44070	1/4" Tubing Bender Pliers.....	81	61410	Angled Hog Ring Pliers.....	57
13300	5 Pc. Filter Socket Set.....	46	27530	Brake Caliper Tool.....	3	44150	1/2" Tubing Bender Pliers.....	81	61450	10 Pc. Heavy Duty End Cap Filter Wrench Set.....	48
13410	Brake Caliper Brush.....	8	27800	Brake Caliper Torx® Bit Set.....	3, 50	44180	Fan Clutch Remover.....	36	61500	17 Pc. Heavy Duty End Cap Filter Wrench Mstr. Set.....	48
13500	41mm Water Pump Wrench for GM 1.6L.....	24	27800	Universal Noid Light.....	28	44210	Universal Emergency Brake Tool.....	7	61750	Metric Clutch Alignment Tool.....	46
13600	Hex Bit Set.....	25	28000	Ratcheting Lock Nut Tool.....	16	44220	Emergency Brake Cable Release Tool.....	7	61850	Truck Hub Seal Installer Kit.....	77
13800	Water Pump Sprckl. Holder for GM Ecotec.....	24	28100	Torque Angle Meter.....	55	44300	Valve Spring Compressor.....	19	61900	Hyv. Duty Bearing Race & Seal Driver Set.....	77
13950	Wheel Stud Pilot Pin Set.....	96	28400	Heavy Duty Circuit Tester.....	71	44480	Large Hose Clamp Vise.....	82	61980	Stripped Screw Extractor Set, 10 Pc.....	53
13970	12mm x 1.25 Wheel Stud Pins.....	96	28500	Strap Wrench.....	26	44500	Small Hose Clamp Vise.....	82	62140	Seized Fastener Remover Kit.....	54
14000	Parts Cleaning Brush.....	8	28600	Disc Brake Piston Tool.....	2	44800	Heavy-Duty Brake Spring Tool.....	5	62200	Heater Hose Coupler Remover.....	23
14020	2-1/2" Wire Cup Brush.....	8	28640	The Ultimate Circuit Tester Kit.....	71	44870	Universal Lift Support Clamp.....	84	62300	Strut Tool.....	12
14040	1" Knot Wire End Brushes.....	8	28830	Digital Circuit Tester 3-49V.....	70	44900	Lock Ring Pliers.....	56	62900	Super Out Set.....	53
14060	1" Crimped Wire End Brushes.....	8	28870	Truck Anchor Pin Bushing Driver.....	79	45000	Steering Wheel Puller.....	35	63000	Fuel Tank Lock Ring Tool.....	41
14100	Valve Core Tool.....	98	28890	Truck Anchor Pin Bushing Driver.....	79	45100	Brake Spring Tool.....	5	63250	Wide Range Oil Filter Wrench.....	49
14160	Scratch Brush.....	8	28950	Truck Wheel Stud Installer.....	97	45300	Harmonic Balancer Puller for GM.....	34	63500	"Big Range" Filter Wrench.....	49
14180	Shoe Handle Wire Brush.....	8	29050	Digital Circuit Tester 3-30V.....	70	45500	Harmonic Balancer Puller.....	34	63600	Impover Filter Wrench.....	49
14440	Water Pump Wrench for GM Northstar.....	24	29500	Quick Quad Pad Spreader.....	1	45750	Inner Tie Rod Tool.....	11	63690	Window Gasket Remover.....	69
14540	Headlight Adjust. Ratchet for Ford.....	81	29150	Universal Brake Caliper Bit Set.....	50	45800	Combin. Int. / Ext. Snap Ring Pliers.....	56	63710	Scissor Disconnects Low Profile 3/8" x 1/2".....	40
14650	3 Pc. Filter Socket Set.....	46	29200	3/8" Hand Impact Tool Set.....	54	46000	Combination Int. / Ext. Snap Ring Pliers.....	56	63720	Scissor Disconnects Low Profile 5/16" x 3/8".....	40
14900	Terminal Tool for GM.....	63	29350	Combination Disc Brake Kit.....	52	46170	Hood Pin with Support.....	84	63730	Scissor Disc AC/Fuel Line Spring Lock.....	40
15000	Engine Cylinder Hone.....	21	29500	High-Low Circuit Tester.....	71	46200	Snap Ring Pliers, Small.....	56	63800	Spring Lock Coupler Disconnect Set, 7 Pc.....	40
15190	Valve Core Tool.....	98	29650	Antenna Nut Socket Set.....	61	46600	Universal Inner Tie Rod Wrench.....	12	63900	Window Holder.....	61
16000	Small Cylinder Hone.....	21	29900	4-WD Bearing Lock-Nut Tool.....	16	46750	Brake Spring Tool.....	5	64250	Right Angle Ratcheting Screwdriver.....	55
16550	Overhead Valve Spring Compressor.....	19	30200	1/2" Hand Impact Tool Set.....	54	46800	Master Inner Tie Rod Kit.....	11	64560	Ignition Module Wrench for Ford.....	55
16750	Valve Spring Compressor.....	19	30280	Automatic Center Punch.....	86	46950	Relay Puller Pliers.....	64	64750	11 Pc. Back Probe Kit.....	67
17100	Flat Band Hose Clamp Pliers.....	82	30500	CV Boot Clamp Pliers.....	16	47000	Windshield Locking Strip Tool.....	59	64900	17 Pc. Back Probe Kit.....	67
17232	Right Angle Funnel.....	92	30650	Offset Boot Clamp Pliers.....	16	47120	Rotary Waterfall Display.....	88	64970	Parasitic Drain Tester.....	66
17252	Transaxle Funnel with Extension.....	91	30750	Hand Impact Tool Set.....	54	47400	Brake Spring Washer Tool.....	4	65000	Alum. Head Spark Plug Hole Repair Kit.....	22
17282	Fluid Extractor/Transfer Pump.....	97	30850	CV Boot Clamp Pliers.....	16	47500	Gondola Display.....	88	65150	Flexible Back Probes.....	67
17350	Pipe Stretcher Kit.....	98	30900	CV Joint Bending Tool.....	16	47600	Large Gondola Display.....	88	65250	Universal Bearing Packager.....	22
17432	18 Gallon Oil Lift Drain.....	93	31050	Flexible Pick-Up Tool.....	76	47800	Large Remover Pliers.....	82	65450	Broken Screw Remover for Ford.....	42
17832	Super Transmission Funnel.....	93	31140	23" Flexible Reaching Tool.....	76	48000	Aluminum Vise Jaw Pads.....	81	65700	Broken Spark Plug Remover Kit for Ford.....	22
17902	Transmission Drain Funnel.....	93	31310	Double Flaring Tool Set.....	61	48100	Rubber Faced Vise Jaw Pads.....	81	65750	Windshield Wiper Arm Remover.....	60
17912	55 Gallon Drum Drain Funnel.....	94	31330	2 or 3 Jaw Rev. & Adj. 5 Ton Puller.....	35	48160	Stocking Tags.....	87	65800	Door Adjuster.....	61
17922	Multi-Drain Tub.....	95	31500	Exhaust/Strut Cutoff Tool.....	37	48300	Push Rod Remover.....	29	66050	Pocket Magnetic Pick-up Tool.....	76
17932	6 Quart Drain Pan.....	95	31550	Axle Hub Bridge Nut Socket for GM.....	15	48400	Import Car Brake Clip Tool.....	4	66540	Mini Flexible Magnetic Pick-Up Tool.....	76
17942	4.5 Gal. Black Pan.....	95	31800	Scribe.....	86	48600	Offset Windshield Locking Strip Tool.....	59	66680	Flexible 23-1/2" Magnetic Pick-Up Tool.....	76
17952	4.5 Gal. Green Pan.....	95	31840	"O" Ring and Seal Pick.....	86	48700	Throttle Pedal Depressor.....	85	67000	Master Line Stopper Set.....	83
18000	Universal Camshaft Bearing Tool.....	25	32000	Pipe End Shaper.....	17	49000	Truck Spring Cage Bolt Socket.....	78	67300	Multi-Position Magnetic Nut Cup.....	74
18232	Offset Funnel with Spout Cap and Lid.....	92	32050	Telescoping Mirror.....	76	49100	T-Handle Single Brake Tool.....	4	67800	Spark Plug Gapper.....	72
18500	Small Ring Compressor.....	18	32150	Power / Ground Outlet.....	68	49200	Heavy Duty Int. / Ext. Snap Ring Pliers.....	56	67870	Sld. / High Energy Spk. Plug Gauge & Gapper.....	72
18520	Stepped Tie Rod Separator.....	10	32500	Tailpipe Expander.....	17	49680	Locking Air Tool Holder.....	75	67900	Spark Plug Gapper.....	72
18530	Stepped Ball Joint Separator.....	10	32750	Tailpipe Expander.....	17	50000	Mini-Cutter.....	81	67950	Standard Feeler Gauge.....	73
18600	Window and Door Clip Remover / Installer.....	57	32860	Door Handle Spring Retainer Tool for GM.....	60	50180	Nut Splitter.....	53	68000	Mini Feeler Gauge.....	73
18700	Hot Stick.....	100	33000	Heavy Duty Circuit Tester / Rel. Tool.....	71	50200	Side Winder Air Hose Reel.....	75	68010	Tube Tappet Feeler Gauge.....	73
18810	Valve Core Torque Tool.....	98	33500	Piston Ring Installer.....	18	50600	Single-Spring Brake Tool.....	6	68100	Deluxe Feeler Gauge.....	72
18980	Pneumatic U-Joint Driver.....	24	33850	Metric Hex Bit Set.....	52	50700	Brake Adjustment Tool.....	6	68130	Wheel Weight Tool.....	97
19000	Take-Apart Ring Compressor.....	18	33900	7mm Hex Brake Caliper Bit.....	3	50750	Oil Filter Pliers.....	49	68150	Go-No-Go Feeler Gauge.....	73
19200	Brake Bleeding Kit.....	5	33920	10mm Hex Brake Caliper Bit.....	3	50850	Ignition Spark Tester.....	43	68210	IPR Socket for Ford 6.0L Diesel.....	32
19202	Low Profile Truck Drain with Lid.....	95	33960	9mm Hex Brake Caliper Bit.....	3	50950	Oil Filter Pliers, Truck / Tractor.....	49	68220	Self-Adjusting Wire Stripper.....	68
19250	Stuck Bolt, Nut, and Stud Remover Set.....	55	34350	Water Sensor Wrench for Duramax.....	20	51000	Heavy Duty Scraper.....	80	68250	Multi-Function Wire Stripper 14-24 Gauge.....	69
19342	Multi-Application Oil Funnel.....	91	34400	Pipe Stretcher.....	17	51250	Spark Plug Wire Puller.....	42	68280	Multi-Function Wire Stripper 8-14 Gauge.....	69
19380	Spark Indicator.....	44	34550	Handy Packer® Bearing Packager.....	14	51350	Putty Knife.....	80	68300	Trim Removal Set, 11 Pc.....	59
19500	2-1/8" - 5" Ring Compressor.....	18	34750	Low Profile Fuel Line Disconnect Set.....	39	51410	Spark Plug Wire Removal Pliers.....	42	68500	Manifold Lid Template for Ford 2V & 3V.....	29
19700	Valve Holder.....	24	34900	Water Sensor Wrench, Late Model.....	20	51420	Offset Spark Plug Wire Removal Pliers.....	42	69200	Test Lead Kit for Relay Test Jumpers.....	65
19702	8 qt. Oil Dispenser with Lid.....	93	34910	Water Sensor Wrench, Aftermarket.....	20	51450	Harmonic Damper Pulley Puller.....	34	69250	Terminal Leads with Power/Switch/Fuse.....	64
19722	Catch-All Drip Pan.....	94	34920	Door Latch Release Tool.....	30	51500	Spark Plug Wire Puller.....	43	69300	Master Relay and Fused Circuit Test Kit.....	64
19732	6 Quart Oil Dispenser White.....	94	35000	Fuel Filter Disconnect for GM.....	39	51600	Spark Plug Wire/Fuel Puller.....	43	69600	Test Probe Kit.....	78
19752	6 Quart Oil Dispenser Red.....	94	35400	Window Belt Adjuster Tool for GM.....	26	51700	Harmonic Balancer Puller Set.....	34	69700	Turbo Air System Test Kit, 13 Pc.....	78
19772	1 Quart Spark Bottle.....	94	35200	Window Belt Adjuster Tool for GM.....	26	51750	Adjustable Spark Plug Wire Puller.....	42	69900	Turbo Air System Test Kit, 9 Pc.....	78
19802	Threaded Oil/Transmission Funnel.....	92	35260	Plastic Fastener Remover.....	57	51900	Spot Weld Chisel.....	61	70440	Flexible Holder with Magnetic Base.....	87
19822	Tire / Tube Test Tank.....	96	35350	Door Panel Remover.....	57	52000	Razor Blade Scraper.....	80	70500	Tap Socket Set 8 Pc.....	85
19832	1.6 qt. Plastic Funnel with Lid & Spout Cap.....	92	35400	Door Upholstery Remover.....	57	52150	100 Pack of Razor Blades.....	80	70940	Tap Socket Set 3 Pc.....	85
19852	Truck & Trailer Wheel Pan.....	78,96	35440	Body Trim Tool Set, 3 Piece.....	55	52400	Fold-Up Scraper.....	37	71020	Master Brake Tool Kit.....	7
19860	Tire Deflator Set for TPMS Valve Stems.....	98	35900	LED Flexible Flashlight.....	87	52500	Mechanic's Stethoscope.....	32	71200	Strut Remover.....	55
19940	Pivot Pin Remover.....	35	36050	Valve Keeper Remover & Installer Kit.....	20	52600	Abrasive Pad Scraper.....	80	71750	LED Quick Change Terminal Tool Set.....	63
20020	Lmtd. Access Spark Plug Chaser M14x1.25.....	43	36200	Valve Keeper Remover & Installer.....	20	52700	Auto Stethoscope.....	32	75000	Vacuum Pump.....	44
20130	Magnetic Glove Dispenser.....	75	36500	Ridge Reamer.....	18	52750	Stethoscope Set.....	32	75500	Combustion Leak Detector.....	28
20200	Spk. Plug Hole & Ox. Sensor Thread Chaser.....	43	36880	Dual Overhead Cam (DOHC) Lock Tool.....	26	52990	Spark Plug Pliers.....	42	75730	Combustion Leak Detector Fluid For Diesel.....	28
20250	Compression Tester.....	29	37000	Air Con. / Fuel Line Disconnect Tool Set.....	39	53100	Adjustable Oil Filter Wrench.....	49	77060	17mm Harmonic Balancer Socket.....	31
20300	Vacuum Gauge and Fuel Pump Tester.....	29	37300	Fuel and AC Disconnect Pliers.....	38	53200	Tractor Oil Filter Wrench.....	47	77800	19mm Harmonic Balancer Socket, Honda.....	31
20400	Shock Absorber Tester.....	12	37410	Camshaft Alignment Kit.....	26	53250	Large Oil Filter Wrench.....	47	77100	21mm Harmonic Balancer Socket.....	31
20500	3-1/2" Ring Compressor.....	18	37430	Camshaft Alignment Tool for GM.....	26	53400	Universal 3" Oil Filter Wrench.....	49	77110	22mm Harmonic Balancer Socket.....	31
20530	10mm Spark Plug Adapter.....	28	37500	Hub Remover Kit for Dodge.....	10	53500	Standard "Swivel Grip" Oil Filter Wrench.....	47	77120	27mm Harmonic Balancer Socket.....	31
20540	1										



LISLE CORPORATION
 807 East Main Street • P.O. Box 89 • Clarinda, IA 51632
 712-542-5101 • Fax 712-542-6591
 www.lislecorp.com

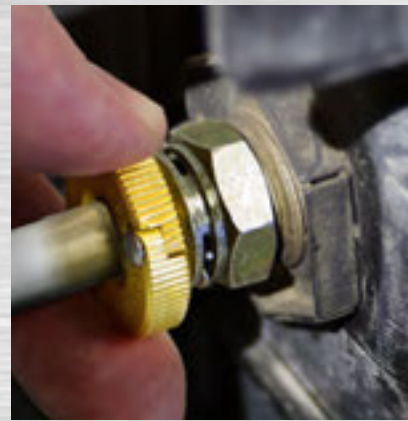

Connect with Lisle Corporation

