

Use with butt connectors on pages 205-211 • *Photos not actual size*

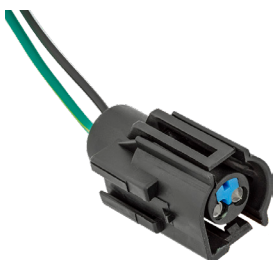

**17683**  
(Not Supplied by O.E.M.)

Coolant Temperature Sensor  
Harness Connector  
Fits Sensor E1AZ-12A648A  
Ford 1981-On

UNIT PACKAGE: 1



**17621**  
(Not Supplied by O.E.M.)

Windshield Washer  
Pump Harness Connector  
Fits Pumps E0AZ-17664-A  
& E30Z-17664-A  
Ford 1968 - On

UNIT PACKAGE: 1

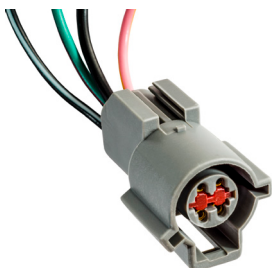

**18216**  
(Not Supplied by O.E.M.)  
Gray Shell

Exhaust Oxygen Sensor  
Harness Connector  
Fits Sensors F0TZ-9F472-A & C,  
F09Z-9F472-A & C,  
F1SZ-9F472-A & F1UZ-9F472-C  
Ford 1995-89

UNIT PACKAGE: 1

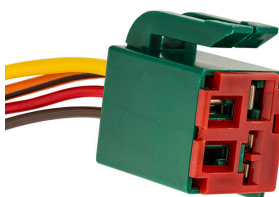

**17622**  
(Not Supplied by O.E.M.)

Fuel Pump Relay Assembly  
Harness Connector  
Fits Relay Assembly  
E3FZ-9345-B  
Ford 1983 - On

UNIT PACKAGE: 1

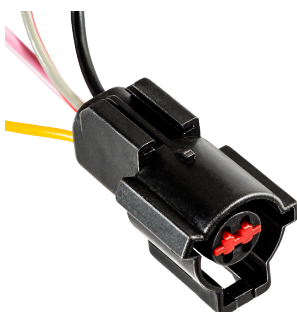

**18215**  
(Not Supplied by O.E.M.)  
Black Shell

Exhaust Oxygen Sensor  
Harness Connector  
Fits Sensors  
F0SZ-9F472-A & B,  
F0TZ-9F472-B & E,  
F02Z-9F472-C &  
F03Z-9F472-A  
Ford 1995-89

UNIT PACKAGE: 1



**20842**  
(Not Supplied by O.E.M.)

Fuel Injectors  
Harness Connector  
One 16 Gauge &  
One 18 Gauge Wire Leads  
with Oval Injector Connectors  
Ford 1999 - On

UNIT PACKAGE: 1

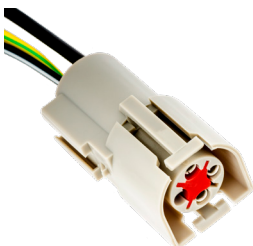

**19889**  
(Not Supplied by O.E.M.)

Exhaust Oxygen Sensor  
Harness Connector  
Used with 3 Wire O2 Sensors  
(Base No. 9F472)  
Ford 1986-On

UNIT PACKAGE: 1



**16968**  
(12085491)

Fuel Injector  
Solenoid Harness Connector  
Fits GM Multi-Port Fuel  
Injector 1711799 on 2.8  
and 3.1 liter engines  
(27 models) 1986 - On  
Fits Fuel Injectors on Ford,  
Chrysler & Imports (Bosch)

UNIT PACKAGE: 1

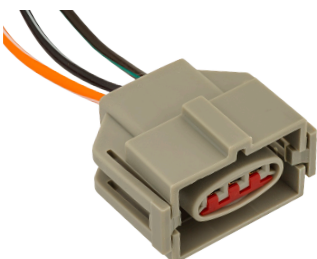

**17662**  
(Not Supplied by O.E.M.)

EGR Sensor  
Harness Connector  
Fits Sensor E6AZ-9J460-A  
Ford Escort, Lynx, Sable &  
Taurus 1988 - On

UNIT PACKAGE: 1

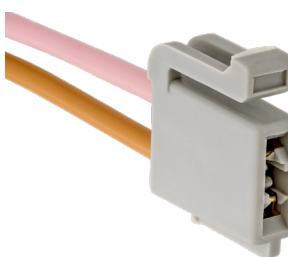

**18671**  
(Not Supplied by O.E.M.)

Air Conditioner  
Clutch Field Coil  
Harness Connector  
Ford

UNIT PACKAGE: 10



**19156**  
(Not Supplied by O.E.M.)

Alternator Regulator &  
Air Conditioner Clutch Field  
Harness Connector  
Ford 1994-On

UNIT PACKAGE: 10

Use with butt connectors on pages 205-211 • *Photos not actual size*

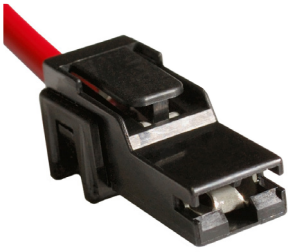

**20846**

(F4VY-14A411-S)

Starter Solenoid  
In-line Repair  
Harness Connector  
12 Gauge Wire Lead  
Ford & Lincoln Town Car  
1997 - 91

UNIT PACKAGE: 1

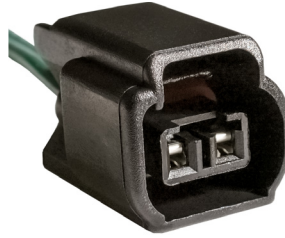

**20845**

(Not Supplied by O.E.M.)

Cam Shaft &  
Crank Shaft Sensors  
Harness Connector  
Two 18 Gauge Leads  
Fits Sensors F0CZ-6B288-A,  
F1AZ-6B288-A, F1AZ-6C315-A  
& XC3Z-6B288-AA  
Ford 1991 - On

UNIT PACKAGE: 1



**19076**

(Not Supplied by O.E.M.)

Master Cylinder,  
Door Jamb Switch  
& Power Mirror  
Harness Connector  
Ford 1987-On

UNIT PACKAGE: 1

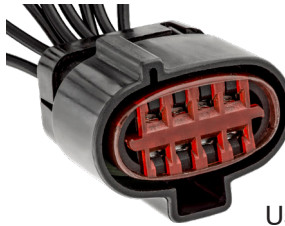

**19880**

(Not Supplied by O.E.M.)

Transmission Gear Shift  
Position Sensor  
Harness Connector  
Eight Wire Leads  
Used with Switch F5TZ-7A247  
on Ford Trucks with E 4 OD Transmission,  
RWD 1989-84 and E, F & U Series 1989-On

UNIT PACKAGE: 1



**19157**

(Not Supplied by O.E.M.)

Variable Speed Sensor  
Harness Connector  
For Speed Sensors with  
Ford Base No. 9E731  
Ford 1993-On

UNIT PACKAGE: 1



**19004**

(F2PZ-14A464C,  
F4UB-14A464A)

Transmission MLP Sensor  
Harness Connector  
E150/350, F250/350 &  
U150 (Bronco)  
1990-On

UNIT PACKAGE: 1

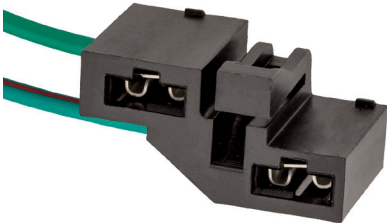

**19813**

(D1AZ-13410-A)

Power Brake  
Harness Connector  
Ford 1965-On

UNIT PACKAGE: 10



**20840**

(Not Supplied by O.E.M.)

Glow Plug Pass thru  
at Valve Cover Gasket  
Harness Connector  
Two 16 Gauge & Three 18 Gauge Wire Leads  
Ford E350, F250-F550SD  
& Excursion 7.3 Diesel 1996 - On

UNIT PACKAGE: 1

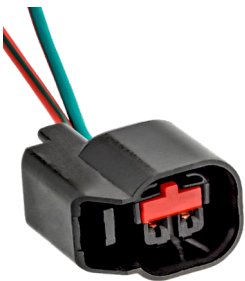

**20561**

(Not Supplied by O.E.M.)

Brake Light Switch  
Harness Connector  
Fits Switches YF1Z-13480-AA  
& YF1Z-13480BA  
Ford, Lincoln  
& Mercury 2000 - On  
Ford Explorer & Mercury  
Mountaineer 1999 - 98

UNIT PACKAGE: 1

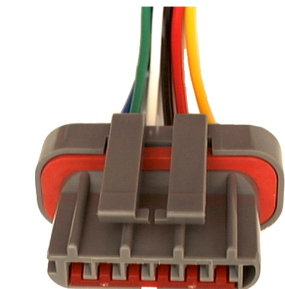

**19885**

(F4PZ-14A411C)

Windshield Wiper Motor  
Harness Connector  
For New Single Connector  
Replacement Motors  
(6 Positions)  
Ford 1987-On

UNIT PACKAGE: 1

Use with butt connectors on pages 205-211 • *Photos not actual size*



**18668**

(Not Supplied by O.E.M.)

In-Tank Fuel Pump & Sending Unit Connector  
Ford 1985 - On



UNIT PACKAGE: 5

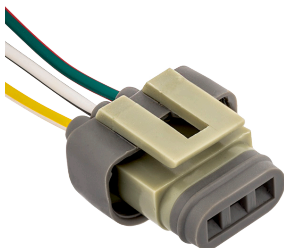

**17659**

(Not Supplied by O.E.M.)

Voltage Regulator Plug Harness Connector  
Sable, Taurus, Tempo & Topaz with Internal Voltage Regulator  
1986 - On

UNIT PACKAGE: 1

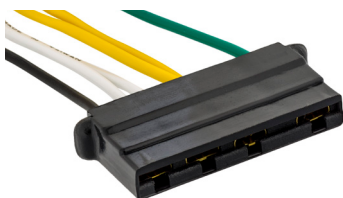

**11445**

Voltage Regulator Harness Connector  
Ford

UNIT PACKAGE: 10

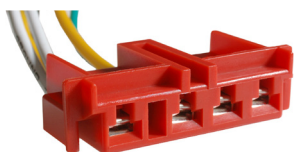

**20850**

(Not Supplied by O.E.M.)

Voltage Regulator Harness Connector  
Four 14 Gauge & two 18 Gauge Wire Leads  
Fits Voltage Regulator F0PZ-10316-A  
Ford 1975 - On

UNIT PACKAGE: 10



**18218**

(Not Supplied by O.E.M.)

Alternator Harness Connector  
Ford Aerostar, Tempo, Topaz, Taurus & Sable with 6 Cylinder Engine & 75 Amp Alternator 1989-On  
4 Cylinder Engine 1985-On

UNIT PACKAGE: 1



**20851**

(1U2Z-14S411-TA, WPT118)

Alternator Harness Connector  
Three 14 Gauge Wire Leads  
Ford 1996 - On

UNIT PACKAGE: 1

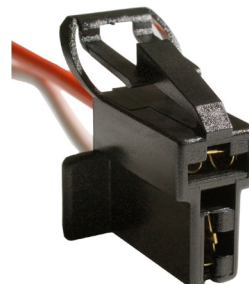

**20838**

(Not Supplied by O.E.M.)

Alternator Harness Connector  
Two 16 Gauge Wire Leads  
100 Amp Alternator  
Ford 1990 - 75

UNIT PACKAGE: 10



**11437**

Dimmer Switch Harness Connector  
Ford & Chrysler

UNIT PACKAGE: 10



**13644**

Right Angle Pigtail  
General Purpose  
11-1/2" Wire Lead for .160 Stud  
Ford

UNIT PACKAGE: 10

**"428" DISPLAY BOARDS**

**428 of the most popular body hardware and fastener items are shrink-wrapped onto seven different boards. Each board contains product groups, body shops are familiar with and use often.**

**The back of each board contains each part number, unit package quantity, OEM number and size specification. The backs are protected by a clear plastic liner.**

**Learn more about the display boards at the front of the catalog, online at [www.auveco.com](http://www.auveco.com) or contact customer service at 1-800-354-9816 or [mail@auveco.com](mailto:mail@auveco.com)**

Use with butt connectors on pages 205-211 • *Photos not actual size*



**12237**

(Chry: 3744750; GM: 12004311, 25015169; Ford: C80Z-13711A)

Instrument Panel Socket for 1/2" Hole  
Bulb No. 158, 194, 194A  
GM, Ford & Chrysler

UNIT PACKAGE: 2



**13233**

(3843432)

Signal & Park Lights  
Bulb No. 198, 1016, 1034,  
1154 & 1157  
Chrysler

UNIT PACKAGE: 1



**9905**

(Chry: 2496279; GM: 2973932;  
AMC: 3509575; IHC: 374985C1)

Instrument Panel Socket  
For 5/8" Hole  
Bulb No. 194  
GM, Chrysler, AMC & International

UNIT PACKAGE: 10



**20389**

(Not Supplied by O.E.M.)

Signal, Stop, Tail &  
Turn Lights  
Bulb No. 1157  
Chrysler including Trucks  
1992 - 89

UNIT PACKAGE: 1

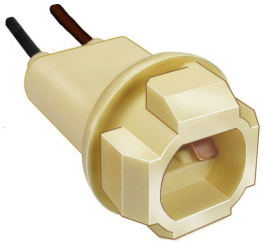

**13541**

(3588314)

Side Marker Assembly  
Bulb No. 194, 194A  
Chrysler

UNIT PACKAGE: 2

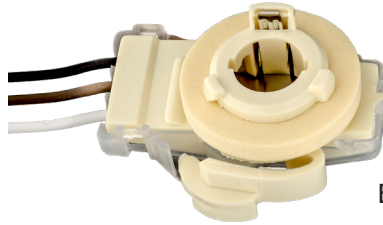

**12600**

(GM: 12003759;  
AMC: 812893)

90° Pigtail &  
Socket Assembly  
Bulb No. 1016, 1034,  
1154 & 1157  
GM & AMC

UNIT PACKAGE: 1

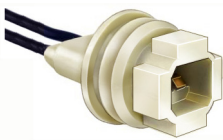

**13542**

(3513686, 4055028)

Side Marker Assembly  
Bulb No. 194, 194A  
Chrysler

UNIT PACKAGE: 2

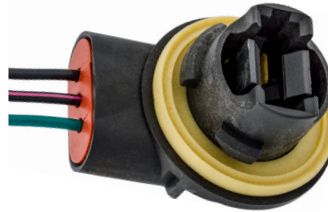

**18921**

(4636360)

Signal, Park &  
Back-Up Lights  
Chrysler 1993-88

UNIT PACKAGE: 1



**12598**

(3764865, 3843245,  
4124721, 4163003)

Single Contact  
with Ground  
Bulb No. 87, 93,  
1073, 1141 & 1156  
Chrysler

UNIT PACKAGE: 1

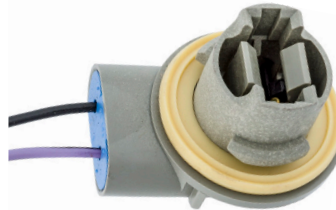

**18920**

(4636362)

Back-Up Lights  
Chrysler 1990-On

UNIT PACKAGE: 1



**12599**

(3764863)

Double Contact with Ground  
Bulb No. 1034, 1154 & 1157  
Chrysler

UNIT PACKAGE: 1



**11157**

(AMC: 4486948;  
GM: 8912698, 6299087)

Signal, Park, Stop &  
Tail Lights  
Bulb No. 1034,  
1154 & 1157  
GM & AMC

UNIT PACKAGE: 1

Use with butt connectors on pages 205-211 • *Photos not actual size*



**16174**

Headlight Socket Assembly  
For Low Beam 9006  
Halogen Bulb  
Single Indexing Groove  
GM, Ford, AMC & Imports

UNIT PACKAGE: 4

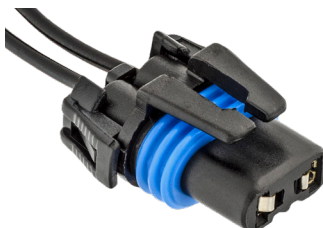

**16175**

(GM: 12101898)

Headlight Socket Assembly  
For High Beam 9005  
Halogen Bulb  
Two Indexing Grooves  
GM, Ford, AMC & Imports

UNIT PACKAGE: 4



**21490**

(GM: 12102664, 88862264  
Ford: 1U2Z-14S411-YA)

Fog & Front Lights, Power  
Steering & Oil Pressure Switch  
Harness Connector  
GM 2005 - 1986  
Ford 2004 - 1995  
Jeep Eagle 1994

UNIT PACKAGE: 1



**16968**

(12085491)

Fuel Injector  
Solenoid Harness Connector  
Fits GM Multi-Port Fuel  
Injector 1711799 on 2.8  
and 3.1 liter engines  
(27 models) 1986 - On  
Fits Fuel Injectors on Ford,  
Chrysler & Imports (Bosch)

UNIT PACKAGE: 1

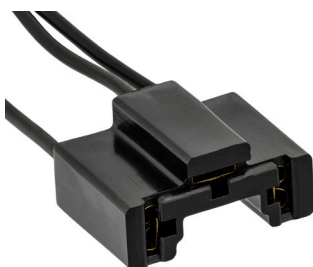

**11437**

Dimmer Switch  
Harness Connector  
Ford & Chrysler

UNIT PACKAGE: 10



**11438**

Temperature Sending Unit  
Harness Connector  
GM  
Voltage Regulator  
Harness Connector  
Chrysler

UNIT PACKAGE: 10

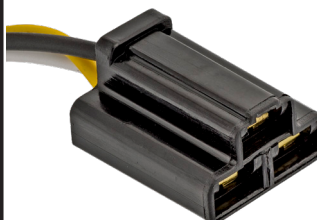

**11440**

(GM: 2962510)

Air Conditioner  
Blower Relay  
Harness Connector  
18 Gauge Wire  
GM, AMC & Chrysler

UNIT PACKAGE: 10



**Auveco releases new items every other week. Our Hot New Items bulletins can keep you up to date on all new product.**

**To receive these bulletins please contact customer service:  
mail@auveco.com or 1-800-354-9816**

**We also have all previous and current bulletins posted on www.auveco.com.**

**IMPORT CAR HARNESS CONNECTORS**

Use with butt connectors on pages 205-211 • *Photos not actual size*



**21210**  
(Not Supplied by O.E.M.)

Universal Headlight Harness Connector  
For H7 Halogen Bulbs  
Two 18 Gauge 6" Long Leads  
Ford, Audi, BMW, Hyundai,  
Kia, Mazda, Mercedes, Mini  
Cooper, Saab & Subaru

UNIT PACKAGE: 1

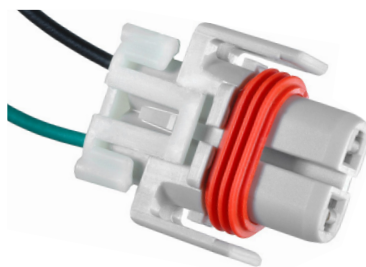

**21220**  
(GM: 88987187)

Headlight Socket  
Assembly  
For H9 Halogen Bulb  
GM, Audi, Mazda,  
Mini-Cooper, Porsche,  
Volkswagen & Volvo

UNIT PACKAGE: 1



**16174**

Headlight Socket Assembly  
For Low Beam 9006  
Halogen Bulb  
Single Indexing Groove  
GM, Ford, AMC & Imports

UNIT PACKAGE: 4



**14918**  
(12048369)

Headlight Socket  
Assembly  
For High-Low 9004 &  
9007 Halogen Bulb  
GM, Ford & Imports

UNIT PACKAGE: 1



**16175**

(GM: 12101898)

Headlight Socket Assembly  
For High Beam 9005  
Halogen Bulb  
Two Indexing Grooves  
GM, Ford, AMC & Imports

UNIT PACKAGE: 4



**16968**  
(12085491)

Fuel Injector  
Solenoid Harness Connector  
Fits GM Multi-Port Fuel  
Injector 1711799 on 2.8  
and 3.1 liter engines  
(27 models) 1986 - On  
Fits Fuel Injectors on Ford,  
Chrysler & Imports (Bosch)

UNIT PACKAGE: 1

**UNIVERSAL SOCKET ASSEMBLY & HARNESS CONNECTORS**

Use with butt connectors on pages 139-147 • *Photos not actual size*



**5219**

Pigtail Connector  
Single Small Wire  
Lead - 12" Long  
For Sockets Housing  
Miniature Lights

UNIT PACKAGE: 10



**5221**

Pigtail Connector  
Double Wire  
Lead - 12" Long  
Aligned Ears  
For Sockets Housing  
Double Contact Lights

UNIT PACKAGE: 10

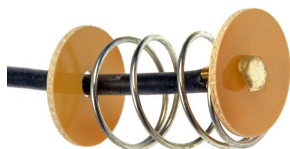

**5220**

Pigtail Connector  
Single Large Wire  
Lead - 12" Long  
For Sockets Housing  
Single Contact Lights

UNIT PACKAGE: 10



**8763**  
(13235-A)

Weatherproof Covered Neoprene  
Signal, Park, Stop & Tail Lights  
Bulb No. 198, 1016, 1034,  
1154 & 1157

UNIT PACKAGE: 10

Use with butt connectors on pages 205-211 • *Photos not actual size*



**8764**

Single Contact License Plate Lights  
For 7/8"-1-1/8" Holes  
Bulb No. 63, 67, 87, 89, 93, 97, 209,  
1003, 1073, 1129, 1133, 1141 & 1156

UNIT PACKAGE: 5

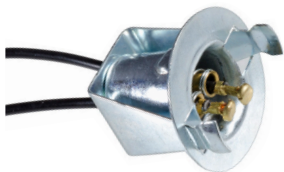

**5226**

Universal Signal, Park,  
Stop & Tail Lights  
For 7/8" to 1-1/8" Hole  
Bulb No. 198, 1016,  
1034, 1154 & 1157

UNIT PACKAGE: 10



**5225**

Pigtail Connector  
Three Wire Sealed Beam  
12" Long - Molded

UNIT PACKAGE: 10



**13554**

Shielded License/Utility Light  
Sealed Socket Assembly  
with Chrome Plastic Shield  
14" Sealed Plastic Boot  
28" Lead with Male Spade Terminal  
Bulb Included-Mounts in 1-1/4" Hole

UNIT PACKAGE: 1



**11439**

Headlight & Flasher  
For all cars using 3 prong  
sealed Headlight Bulbs 4002,  
3, 5, 5040, 2, 5400, 2,  
40, 421, 6006, 12 & 13  
Also fits 2 & 3 Prong Flashers

UNIT PACKAGE: 10



**16968**

(12085491)

Fuel Injector  
Solenoid Harness Connector  
Fits GM Multi-Port Fuel  
Injector 1711799 on 2.8  
and 3.1 liter engines  
(27 models) 1986 - On  
Fits Fuel Injectors on Ford,  
Chrysler & Imports (Bosch)

UNIT PACKAGE: 1



**13559**

Headlight & Flasher  
For all cars using 2 prong  
Sealed Headlight  
Bulb No. 4001

UNIT PACKAGE: 3



**16966**

Three terminal Flasher connector pigtail  
designed specifically for heavy duty  
thermal and electronic flashers with  
variable and fixed loads - single  
and alternating flash patterns.  
Features three 10" long 14  
gauge GXL wire leads.

UNIT PACKAGE: 2



**9901**

Pigtail Connector  
Single Wire Lead  
16 Gauge - 12" Long  
Receptacle for use wherever there is a  
junction of two or more wires; such as behind an  
instrument panel or in an engine compartment.

**Use with Auveco 9900**

UNIT PACKAGE: 20



**9900**

Pigtail Connector  
Single Wire Lead  
16 Gauge - 12" Long  
Snap plug for use wherever there is a  
junction of two or more wires; such as behind an  
instrument panel or in an engine compartment.

**Use with Auveco 9901**

UNIT PACKAGE: 20



**8770**

2 Way Harness Connector  
7-1/2" Leads - 18 Gauge  
For Automotive, Truck and Marine  
Use where a double harness is required  
Also used on Trailers and Farm Implements

UNIT PACKAGE: 5



**8768**

3-Way Harness Connector  
7-1/2" Leads  
Color Coded Wire Automotive  
For Truck and Marine  
Use where a Triple Harness is required  
**Use with Auveco 8769**

UNIT PACKAGE: 5

Use with butt connectors on pages 205-211 • *Photos not actual size***8769**

3-Way Harness Connector  
7-1/2" Leads  
Color Coded Wire  
For Automotive, Truck and Marine  
Use where a Triple Harness is required  
**Use with Auveco 8768**

UNIT PACKAGE: 5

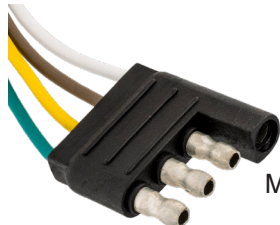
**10222**

4 Way Harness Connector  
12" Leads - 18 Gauge  
For Automotive, Truck, Trailer,  
Marine and Farm Implement Use  
**Use with Auveco 10223**

UNIT PACKAGE: 5

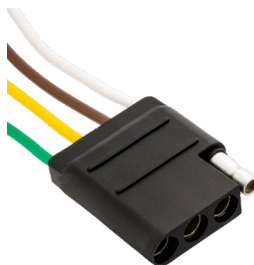
**10223**

4 Way Harness Connector  
12" Leads - 18 Gauge  
For Automotive, Truck, Trailer,  
Marine and Farm Implement Use  
**Use with Auveco 10222**

UNIT PACKAGE: 5

**10782**

4 Way Harness Connector  
48" Wire Leads - 18 Gauge  
For Automotive, Truck, Trailer,  
Marine and Farm Implement Use  
**Use with Auveco 10783**

UNIT PACKAGE: 2

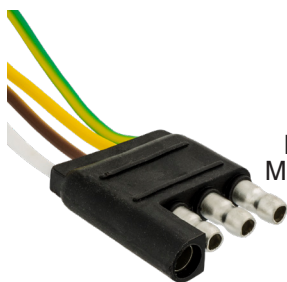
**10783**

4 Way Harness Connector  
48" Wire Leads - 18 Gauge  
For Automotive, Truck, Trailer,  
Marine and Farm Implement Use  
**Use with Auveco 10782**

UNIT PACKAGE: 2

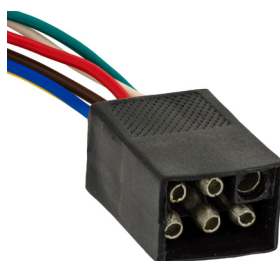
**11434**

Six Way Trailer Connector  
6 Color Coded Wire Leads  
For Trailer Application (Male)  
**Use with Auveco 11435**

UNIT PACKAGE: 5

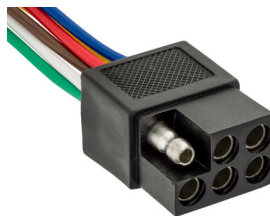
**11435**

Six Way Trailer Connector  
6 Color Coded Wire leads  
For Trailer Application  
(Female)  
**Use with Auveco 11434**

UNIT PACKAGE: 5

**13634**

Complete 4-Way Trailer Connector  
Polarized four prong  
Chrome plated die cast housing  
2-hole flange mounting  
1-13/16" on centers  
Mounting bracket available

UNIT PACKAGE: 1 Set

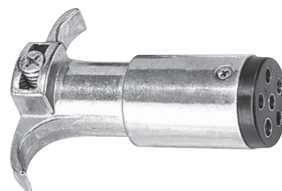
**13639**

6-Way Trailer  
Connector Plug

UNIT PACKAGE: 1

**13636**

Complete 6-Way Trailer Connector  
Assembly consists of  
13639 plug and 13640 socket.  
Specifically designed for  
Recreational Vehicles  
Die cast plug housing is  
chrome plated and socket is a  
one piece plastic molded unit  
complete with plated spring  
loaded cover and a special  
moisture and dust-proof boot.

UNIT PACKAGE: 1 Set

**13643**

Universal Bracket  
For use with 13634 and  
13640 trailer connectors.  
Designed to fit under  
trailer high ball  
Heavy gauge zinc plated steel

UNIT PACKAGE: 2



# MINIATURE BULBS

Wagner Miniature Bulbs • *Photos not actual size*



Auveco Part No.	Type	Replaces Bulb No.	Unit Pkg.
16899	1	1157	10
16901	1	1157NA	10
16902	2	194	10
16904	3	1156	10
16905	4	67	10
16906	4	1895	10
16907	1	2057	10
16908	1	2057NA	10
16909	5	1893	10
16910	4	57	10
16911	4	89	10
16912	4	97	10
16913	6	211-2	10
16914	4	53	10
16915	7	3057	10
16916	7	3057NA	10
16917	7	3157	10
16918	3	1003	10
16919	5	1816	10
16920	17	1004	10
16921	2	168	10
16922	10	906	10
16923	3	1141	10
16924	1	198	10
16925	1	1034	10
16926	3	93	10
16927	8	PR2	10
17597	3	1156NA	10
17994	9	13050	10
17995	9	12100	10
17996	18	3156	10
17997	18	3155	10

Auveco Part No.	Type	Replaces Bulb No.	Unit Pkg.
17998	3	2396	10
17999	1	2357	10
18000	1	2357NA	10
18001	7	3157NA	10
18002	5	1891	10
18003	5	1889	10
18004	3	1073	10
18005	10	921	10
18006	10	916	10
18007	10	916NA	10
18008	10	912	10
18010	11	561	10
18011	6	212-2	10
18012	2	194NA	10
18013	2	193	10
18014	2	158	10
18015	12	90	10
18016	2	74	10
18017	13	24	10
18018	13	24NA	10
18465	2	37	10
18466	3	199	10
18467	4	293	10
18468	4	631	10
18469	17	1076	10
18470	4	1155	10

A - Amber (Darker)  
 LL - Long Life  
 NA - Natural Amber (Lighter)  
 SA - Special Application

*Continued on next page*

## MINIATURE BULBS

Wagner Miniature Bulbs • *Photos not actual size*



Type 1



Type 2



Type 3



Type 4



Type 5



Type 7



Type 9



Type 10



Type 11



Type 12



Type 14



Type 15



Type 16



Type 18



Type 19



Type 20



Type 21

Auveco Part No.	Type	Replaces Bulb No.	Unit Pkg.
18472	4	1445	10
18473	14	1449	10
18474	5	1815	10
18475	18	3156NA	10
18476	7	3157NA-SA	10
18477	15	3357	10
18478	15	3357NA	10
18479	15	3157SA	10
19206	16	7440	2
19207	16	7443	2
19208	3	1295NA	10
20282	4	55	10
20283	4	63	10
20284	2	73	10
20285	2	161	10
20286	2	192	10
20287	19	222	10
20289	11	562	10
20291	10	904	10
20292	12	68	10
20294	10	922	10

Auveco Part No.	Type	Replaces Bulb No.	Unit Pkg.
20295	1	1638	10
20296	20	3496	10
20298	2	3652	10
20299	9	11005	10
20300	9	11006	10
20585	1	1176	10
20587	7	3457	10
20588	7	3457NA	10
20589	5	17131	10
20590	21	17171	10
20591	2	17177	10
20593	1	17916	10
20620	7	4157LL	2
20621	7	4157NALL	2
20681	1	1142	10
20859	7	3757NALL	2

A -Amber (Darker)  
 LL - Long Life  
 NA -Natural Amber (Lighter)  
 SA - Special Application

# WAGNER HALOGEN LIGHT BULBS

*Photos not actual size*

**Sec. 12**



**16896**

9004/HB1 Bulb  
High-Low Beam in Single Headlight  
Assemblies  
Volts: 12-18  
Watts: 25-65

**Use with Auveco Socket 14918**

UNIT PACKAGE: 1



**18662**

9007/HB5 Bulb  
High-Low Beam  
Volts: 12.8  
Watts: 55-65

**Use with Auveco Socket 14918**

UNIT PACKAGE: 1



**16897**

9005/HB3 Bulb  
High Beam in Dual Headlight Assemblies  
Volts: 12.8  
Watts: 65

**Use with Auveco Socket 16175**

UNIT PACKAGE: 1



**16898**

9006/HB4 Bulb  
Low Beam in Dual Headlight Assemblies  
Volts: 12.8  
Watts: 55

**Use with Auveco Socket 16174**

UNIT PACKAGE: 1



**20683**

886 Bulb

UNIT PACKAGE: 1



**20595**

881 Bulb

UNIT PACKAGE: 1



**18661**

9003/HB2 Bulb  
High-Low Beam  
Volts: 12.0  
Watts: 55-60

**Use with Auveco Socket 5225**

UNIT PACKAGE: 1



**20601**

1260/H4 Bulb

UNIT PACKAGE: 1



**20596**

885 Bulb

UNIT PACKAGE: 1



**20599**

893 Bulb

UNIT PACKAGE: 1



**19209**

2040 Bulb  
Center Grille  
Mercury Sable and Villager

UNIT PACKAGE: 1



**20598**

891 Bulb

UNIT PACKAGE: 1



**20600**

1255/H3 Bulb

UNIT PACKAGE: 1

## BULB NUMBER TO AUVECO'S WAGNER BULB NUMBER

Bulb No.	Auveco No.	Bulb No.	Auveco No.	Bulb No.	Auveco No.
H3	20600	881	20595	2057NA	16908
H4	20601	885	20596	2357	17999
HB1	16896	886	20683	2357NA	18000
HB2	18661	891	20598	2396	17998
HB3	16897	893	20599	3057	16915
HB4	16898	904	20291	3057NA	16916
HB5	18662	906	16922	3155	17997
PR2	16927	912	18008	3156	17996
24	18017	916	18006	3156NA	18475
24NA	18018	916NA	18007	3157	16917
37	18465	921	18005	3157NA	18001
53	16914	922	20294	3157NA-SA	18476
55	20282	1003	16918	3157SA	18479
57	16910	1004	16920	3357	18477
63	20283	1034	16925	3357NA	18478
67	16905	1073	18004	3457	20587
68	20292	1076	18469	3457NA	20588
73	20284	1141	16923	3496	20296
74	18016	1142	20681	3652	20298
89	16911	1155	18470	3757NALL	20859
90	18015	1156	16904	4157LL	20620
93	16926	1156NA	17597	4157NALL	20621
97	16912	1157	16899	7440	19206
158	18014	1157NA	16901	7443	19207
161	20285	1176	20585	9003/HB2	18661
168	16921	1255/H3	20600	9004/HB1	16896
192	20286	1260/H4	20601	9005/HB3	16897
193	18013	1295NA	19208	9006/HB4	16898
194	16902	1445	18472	9007/HB5	18662
194NA	18012	1449	18473	11005	20299
198	16924	1638	20295	11006	20300
199	18466	1815	18474	12100	17995
211-2	16913	1816	16919	13050	17994
212-2	18011	1889	18003	17131	20589
222	20287	1891	18002	17171	20590
293	18467	1893	16909	17177	20591
561	18010	1895	16906	17916	20593
562	20289	2040	19209		
631	18468	2057	16907		

### Halogen Bulb Industry Standard Number to Auveco Harness Connector Number

Halogen Bulb No.	Auveco Harness No.	Halogen Bulb No.	Auveco Harness No.	Halogen Bulb No.	Auveco Harness No.
880	21490	898	16694	H8	16694
881	16694	899	21490	H9	21220
884	21490	9003	11439	H10	16175
885	21490	9004	14918	H11	16694
886	16694	9005	16175	H12	16175
889	16694	9006	16174	HB1	14918
890	21490	9007	14918	HB2	11439
892	21490	9055	16175	HB3	16175
893	21490	H4	11439	HB4	16174
894	16694	H7	21210		
896	16694				

# HIGH PERFORMANCE IMPORTED MINIATURE BULBS

*Photos not actual size*



Type 1



Type 2



Type 3



Type 4



Type 5



Type 9



Type 10



Type 12



Type 13



Type 15



Type 16



Type 18



Type 22

Auveco Part No.	Type	Replaces Bulb No.	Unit Pkg.
B24	13	24	10
B24A	13	24A	10
B53	4	53	10
B57	4	57	10
B67	4	67	10
B67A	4	67A	10
B68	12	68	10
B89	4	89	10
B97	4	97	10
B168	2	168	10
B194	2	194	10
B194-100	2	194	100
B194A	2	194A	10
B906	10	906	10
B906A	10	906A	10
B912	10	912	10
B916	10	916	10
B916A	10	916A	10
B921	10	921	10
B921A	10	921A	10
B1141	3	1141	10
B1156	3	1156	10
B1156A	3	1156A	10
B1157	1	1157	10
B1157A	1	1157A	10
B1893	5	1893	10
B1895	4	1895	10
B2057	1	2057	10
B2057A	1	2057A	10
B2357	1	2357	10
B2357A	1	2357A	10
B2721	2	2721	10
B2722	2	2722	10
B2821	2	2821	10

Auveco Part No.	Type	Replaces Bulb No.	Unit Pkg.
B2825	2	2825	10
B2827	2	2827	10
B3057	15	3057	10
B3057A	15	3057A	10
B3156	18	3156	10
B3156A	18	3156A	10
B3157	15	3157	10
B3157A	15	3157A	10
B3357	15	3357	10
B3357A	15	3357A	10
B3457	15	3457	10
B3457A	15	3457A	10
B3893	5	3893	10
B4114K	15	4114K	10
B4157	15	4157	10
B4157K	15	4157K	10
B5007	5	5007	10
B5008	5	5008	10
B6411	9	6411	10
B6413	9	6413	10
B6418	9	6418	10
B6438	9	6438	10
B6461	9	6461	10
B7225	1	7225	10
B7440	22	7440	10
B7440A	22	7440A	10
B7443	16	7443	10
B7443A	16	7443A	10
B7505	22	7505	10
B7506	3	7506	10
B7507	3	7507	10
B7515	16	7515	10
B7528	1	7528	10

# HIGH PERFORMANCE IMPORTED HALOGEN BULBS

*Photos not actual size*



**B880**

880 Bulb

UNIT PACKAGE: 1



**B890**

890 Bulb

UNIT PACKAGE: 1



**B881**

881 Bulb

UNIT PACKAGE: 1



**B891**

891 Bulb

UNIT PACKAGE: 1



**B884**

884 Bulb

UNIT PACKAGE: 1



**B893**

893 Bulb

UNIT PACKAGE: 1



**B885**

885 Bulb

UNIT PACKAGE: 1



**B894**

894 Bulb

UNIT PACKAGE: 1



**B886**

886 Bulb

UNIT PACKAGE: 1



**B896**

896 Bulb

UNIT PACKAGE: 1



**B889**

889 Bulb

UNIT PACKAGE: 1



**B899**

899 Bulb

UNIT PACKAGE: 1

# HIGH PERFORMANCE IMPORTED HALOGEN BULBS

*Photos not actual size*

**Sec. 12**



## **B9004**

9004/HB1 Bulb  
High-Low Beam in  
Single Headlight Assemblies  
Volts: 12-18  
Watts: 25-65

**Use with Auveco Socket 14918**

UNIT PACKAGE: 1



## **BD2C**

D2C Bulb

UNIT PACKAGE: 1



## **B9005**

9005/HB3 Bulb  
High Beam in  
Dual Headlight Assemblies  
Volts: 12.8  
Watts: 65

**Use with Auveco Socket 16175**

UNIT PACKAGE: 1



## **BD2R**

D2R Bulb

UNIT PACKAGE: 1



## **B9006**

9006/HB4 Bulb  
Low Beam in  
Dual Headlight Assemblies  
Volts: 12.8  
Watts: 55

**Use with Auveco Socket 16174**

UNIT PACKAGE: 1



## **BD2S**

D2S Bulb

UNIT PACKAGE: 1



## **B9007**

9007/HB5 Bulb  
High-Low Beam  
Volts: 12.8  
Watts: 55-65

**Use with Auveco Socket 14918**

UNIT PACKAGE: 1



## **BH1**

H1 Bulb

UNIT PACKAGE: 1



## **BD1S**

D1S Bulb

UNIT PACKAGE: 1



## **B64150ULT**

H1LL/ 64150ULT Bulb

UNIT PACKAGE: 1

# HIGH PERFORMANCE IMPORTED HALOGEN BULBS

*Photos not actual size*



**BH3**

H3/12V 55W Bulb  
UNIT PACKAGE: 1



**B64193**

H4/ 64193 Bulb  
UNIT PACKAGE: 1



**B64193ULT**

H4LL/ 64193ULT Bulb  
UNIT PACKAGE: 1



**B64132**

H6W/ 64132 Bulb  
UNIT PACKAGE: 10



**BH7**

H7 Bulb  
UNIT PACKAGE: 1



**B64210ULT**

H7LL/ 64210ULT Bulb  
UNIT PACKAGE: 1



**BH9**

H9 Bulb  
UNIT PACKAGE: 1



**BH10**

H10/9145 Bulb  
UNIT PACKAGE: 1



**B64113**

H10W/ 64113 Bulb  
UNIT PACKAGE: 10



**BH11**

H11 Bulb  
UNIT PACKAGE: 1



**BH13**

H13/9008 Bulb  
UNIT PACKAGE: 1



# HIGH PERFORMANCE IMPORTED BULBS

## Bulb Number to Auveco's High Performance Imported Bulb Number

Halogen Bulb No.	Auveco No.	Halogen Bulb No.	Auveco No.	Halogen Bulb No.	Auveco No.
24	B24	1157A	B1157A	7440A	B7440A
24A	B24A	1893	B1893	7443	B7443
53	B53	1895	B1895	7443A	B7443A
57	B57	2057	B2057	7505	B7505
67	B67	2057A	B2057A	7506	B7506
67A	B67A	2357	B2357	7507/Amber	B7507
68	B68	2357A	B2357A	7515	B7515
89	B89	2721	B2721	7528	B7528
97	B97	2722	B2722	9004	B9004
168	B168	2821	B2821	9005	B9005
194	B194	2825	B2825	9006	B9006
194A	B194A	2827/Amber	B2827	9007	B9007
880	B880	3057	B3057	9008	BH13
881	B881	3057A	B3057A	9145	BH10
884	B884	3156	B3156	D1S	BD1S
885	B885	3156A	B3156A	D2C	BD2C
886	B886	3157	B3157	D2R	BD2R
889	B889	3157A	B3157A	D2S	BD2S
890	B890	3357	B3357	H1	BH1
891	B891	3357A	B3357A	H1LL	B64150ULT
893	B893	3457	B3457	H3	BH3
894	B894	3457A	B3457A	H4	B64193
896	B896	3893	B3893	H4LL	B64193ULT
899	B899	4114K	B4114K	H6W	B64132
906	B906	4157	B4157	H7	BH7
906A	B906A	4157K	B4157K	H7LL	B64210ULT
912	B912	5007	B5007	H9	BH9
916	B916	5008	B5008	H10	BH10
916A	B916A	6411	B6411	H10W	B64113
921	B921	6413	B6413	H11	BH11
921A	B921A	6418	B6418	H13	BH13
1141	B1141	6438	B6438	HB1	B9004
1156	B1156	6461	B6461	HB3	B9005
1156A	B1156A	7225	B7225	HB4	B9006
1157	B1157	7440	B7440	HB5	B9007

## Bulb Number to Auveco's Premium Imported Bulb Number

Bulb No.	Auveco No.	Bulb No.	Auveco No.
24NA	20702	1893	20715
89	20705	2040	20717
168	20706	2357	20720
880	20854	2357NA	20721
881	20855	3057	20722
885	20856	3457	20728
889	20857	3457NA	20729
916NA	20712	3496	20730

NA- Natural Amber (Lighter)

**PREMIUM IMPORTED MINIATURE BULBS**

*Photos not actual size*



Type 1



Type 2



Type 4



Type 5



Type 7



Type 10



Type 13



Type 20

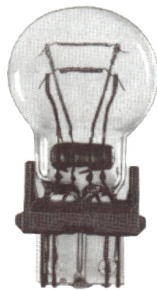

Type 23

Auveco Part No.	Type	Replaces Bulb No.	Unit Pkg.
20702	13	24NA	10
20705	4	89	10
20706	2	168	10
20712	10	916NA	10
20715	5	1893	10
20720	1	2357	10
20721	1	2357NA	10
20722	7	3057	10
20728	23	3457	10
20729	23	3457NA	10
20730	20	3496	10

**PREMIUM IMPORTED HALOGEN BULBS**



**20855**

881 Bulb

UNIT PACKAGE: 1



**20717**

2040 Bulb  
Center Grille  
Mercury Sable and Villager

UNIT PACKAGE: 1

**All items available in bulk quantities.**

**Call customer service  
1-800-354-9816  
for a price quote**



**20857**

889 Bulb

UNIT PACKAGE: 1



**20856**

885 Bulb

UNIT PACKAGE: 1



**20854**

880 Bulb

UNIT PACKAGE: 1

**SWITCHES**

*Photos not actual size*

**Push-Pull Switches**

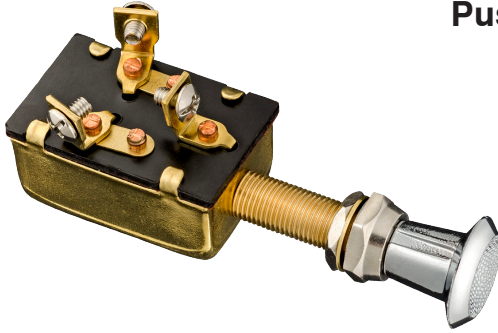

**13552**

Marine Switch  
3 Position "Off-On-On"  
First 'On' position energizes one circuit.  
In second "On" position both circuits are energized.  
Mounting stem 1-1/4" long. 3/8" diameter.  
Brass hex back-up nut, brass washer, chrome plated  
brass face nut and chrome plated knob.  
15 Amps @ 12 Volts

UNIT PACKAGE: 1

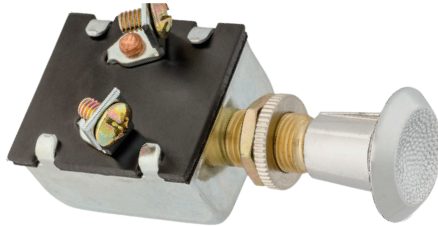

**12077**

Push-Pull Switch  
Heavy Duty  
2 position "Off-On" switch with 2 Screw Terminals.  
25 Amps @ 6 Volts; 15 Amps @ 12 Volts

UNIT PACKAGE: 1



**Push Button Switch**  
Heavy Duty Construction

**12078**

Horn Button  
UNIT PACKAGE: 1

**TOGGLE & ROCKER SWITCHES**



**13555**  
Brass

S.P. S.T. Toggle Switch  
"Off-On"  
Mounting Stem 3/8" long  
Diameter: 7/16" with  
7/16" x 28 threads  
Rating: 35 Amps @ 6 Volts  
20 Amps @ 12 Volts

UNIT PACKAGE: 1

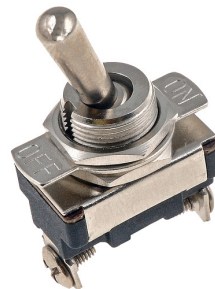

**13630**

S.P. S.T. Toggle Switch "Off-On"  
Phenolic Housing  
Mounting Stem 15/32" long  
Diameter: 15/32"  
2 Screw Terminals  
Bat Handle  
Rating: 15 Amps 125 Volts AC  
10 Amps 250 Volts AC  
3/4 HP 120-240 Volts AC

UNIT PACKAGE: 1



**13632**

D.P. D.T. Toggle Switch  
"On-Off-On"  
Phenolic Housing  
Mounting Stem 15/32" long  
Diameter: 15/32"  
6 Screw Terminals  
Rating: 15 Amps 125 Volts AC  
10 Amps 250 Volts AC  
3/4 HP 120-240 Volts AC

UNIT PACKAGE: 1



**13631**

S.P. D.T. Toggle Switch "On-Off-On"  
Phenolic Housing  
Mounting Stem 15/32" long  
15/32" Diameter  
3 Screw Terminals  
Bat Handle  
Rating: 15 Amps 125 Volts AC  
10 Amps 250 Volts AC  
3/4 HP 120-240 Volts AC

UNIT PACKAGE: 1

*Photos not actual size*



**13629**

S.P. S.T. Toggle Switch "Off-On"  
Two 6" Wire Leads  
Nickel plated "Off-On" indicator plate assembled  
Mounting Stem 3/8" long  
Diameter: 15/32" diameter  
Bat handle  
Rating: 15 Amps 12 Volts DC  
6 Amps 125 Volts AC

UNIT PACKAGE: 1



**12076**

Chrome Plated Handle

Heavy Duty Toggle Switch  
2 Position "On-Off"  
Stem Diameter: 15/32"  
Low Voltage -High Amp Application  
Rating: 35 Amps @ 6-12 Volts DC

UNIT PACKAGE: 1

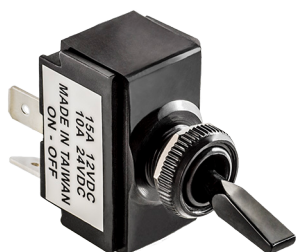

**13556**

Toggle Switch  
2 Positions "On-Off"  
For lights, blower, pump, etc.  
Black plastic paddle and locking ring with level seal and knurled cap nut

Sealed to resist water penetration.  
Fits panels up to 1/4" thick  
Requires 15/32" Mounting Hole  
Rating: 20 Amps @ 12 Volts D.C. with 1/4" spade terminals

UNIT PACKAGE: 1

**13514**

Black Molded Bat Handle

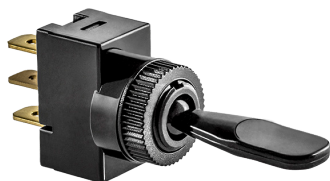

Heavy Duty S.P. D.T. Toggle Switch  
3 Position "On-Off-On"  
3 Blade Terminals  
Spring loaded for positive snap action  
Includes bezel nut and collar  
Fits in 1/2" diameter hole  
Rating: 16 Amps @12 Volts

UNIT PACKAGE: 1

**Illuminated Toggle Switches**

2 Position "Off-On"  
Handle illuminated in 'On' position  
With bezel nut and back-up collar for mounting in 1/2" hole.  
Rating: 20 Amps @ 12 Volts



Auveco Part No.	Color
<b>13523</b>	Red illuminated toggle
<b>13524</b>	Green illuminated toggle
<b>12236</b>	Amber illuminated toggle

UNIT PACKAGE: 1

**Illuminated Rocker Switches**

2 Position "Off-On"  
Rocker illuminated in 'On' position  
Snaps into 1" x 1/2" rectangular hole  
Rating: 20 Amps. @ 12 Volts



Terminal Coding:  
1 -Power  
2 -Accessory  
3 -Ground

Auveco Part No.	Color
<b>12234</b>	Red illuminated rocker
<b>13529</b>	Green illuminated rocker
<b>13530</b>	Amber illuminated rocker
<b>13531</b>	Blue illuminated rocker

UNIT PACKAGE: 1

**13528**

Non-illuminated Rocker Switch  
2 position "Off-On"  
Fits 1-1/8" x 7/16" rectangular hole  
Rating: 20 Amps @ 12 Volts



UNIT PACKAGE: 1

**Illuminated Toggle Switch Mounting Panel**

**12233**

1-1/8" x 7/16" Hole  
Use with Auveco 12234, 13529, 13530 & 13531

UNIT PACKAGE: 1

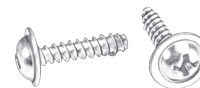

# TOGGLE SWITCHES

*Photos not actual size*

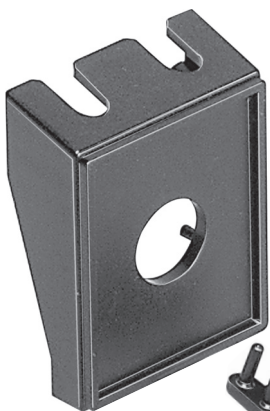

## Illuminated Toggle Mounting Panel

**12235**

1/2" Hole Diameter

UNIT PACKAGE: 1



## Indicator Lamps

Has wire leads for easy installation  
Mounts into 1/2" hole  
12 Volt application  
Installs in Auveco  
Mounting Panel 12235

Auveco  
Part No.

Color

20477	Red Lens
13520	Green Lens
13521	Amber Lens
13522	Blue Lens

UNIT PACKAGE: 1

# WIRE LOOM CLIPS



**1340**

Wire Loom Clips  
Clamping  
Diameter: 1/4"

UNIT PACKAGE: 100



**1341**

Wire Loom Clips  
Clamping Diameter: 3/16"

UNIT PACKAGE: 100

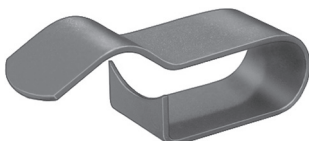

**3758**

Wire Loom Clips  
Clamping Diameter: 3/8"

UNIT PACKAGE: 100



**14388**

(145525)

Heavy Duty  
Frame Wiring Clip  
Clamping Diameter: 3/16"  
Fits panels from .030"-.230"

UNIT PACKAGE: 50



**9864**

(372741-S100)

General Purpose  
Wire Loom Clip

UNIT PACKAGE: 100

# ROUTING CLIPS



## Nylon Cable Clips

Auveco Part No.	Cable Size	Screw Size	Unit Pkg.
13939	3/16"	#8-10	50
13944	1/2"	#8-10	50



**13937**

Nylon Spring Clip

Width: 3/8"  
Overall Length: 1-5/16"  
Thickness: .060  
Use with #8 Screw

UNIT PACKAGE: 50



## Nylon Tubing & Hose Clips

Adhesive Backed

Auveco Part No.	Range	Unit Pkg.
10057	5/32" to 1/4"	10
10058	5/16" to 1/2"	10
10059	9/16" to 3/4"	10



## Cable Clips for Co-Ax Cable

Polyethylene clips with corrosion resistant galvanized steel nail.

**15854**

Cable Diameter: 3/16"-9/32"  
Nail Length: 1"

UNIT PACKAGE: 50



**Strain-Relief Cable Connector**

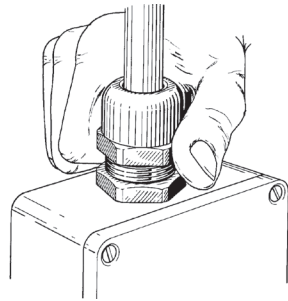

Photo not actual size

Reliable, liquid-tight, nylon strain-relief cable connector for quick and easy installation. They do not have to be disassembled before using. Simply insert a cable into the connector, tighten the cap nut and the cable is automatically fixed, centered, and strain relieved.

**15851**

Wire Diameter: .236" - .472"  
Thread: 1/2" NPT  
Thread Length (Bottom): .512"  
Hex: .945"

UNIT PACKAGE: 5



**Routing Clips**

A quick, economical method of fastening wires, tubes, hoses or rods from 1/4" to 1" diameter to metal, plastic or any other surface ranging from 1/32" to 1/8" thickness. Clips are molded of durable black nylon plastic. They snap into 1/4" diameter holes and are held firmly in place by flexible "snubber tips" which compensate for variation in wall thickness.

Auveco Part No.	Tube/Hose Wire Outside Dia.	Clip Overall Height	Clip Height Above Panel	Unit Pkg.
14529	1/4"	27/32"	7/16"	25
14530	3/8"	29/32"	15/32"	25
14531	1/2"	1-1/16"	5/8"	25
14532	5/8"	1-3/16"	3/4"	25
14533	3/4"	1-5/16"	7/8"	25

**Wire Loom Routing Clips**

Black Nylon • Also called split flexible tubing, convoluted conduit or wiring harness

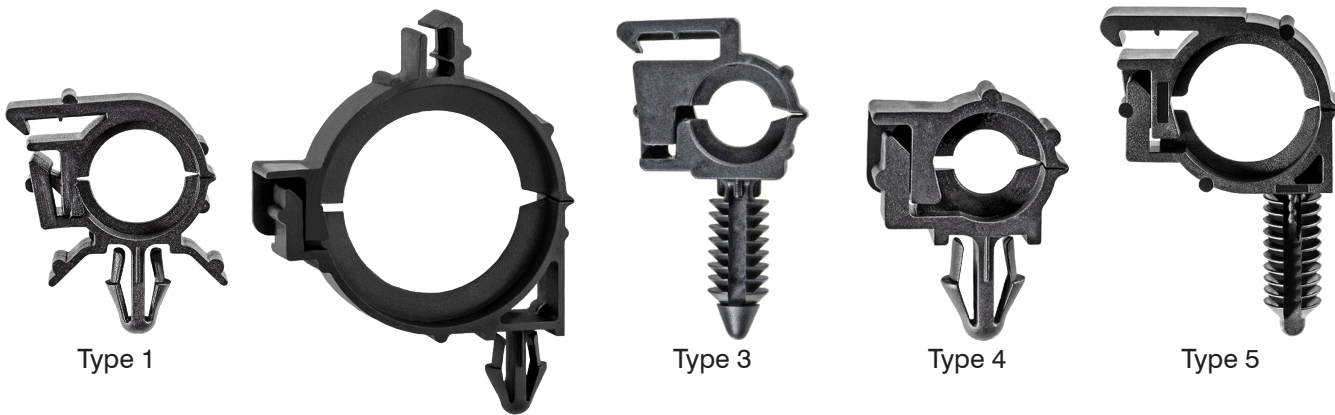

Auveco Part No.	Type	For Conduit Size		GM No.	Unit Pkg.
		I.D.	O.D.		
19440	3	1/4"	3/8"	12040984	15
19795	4	1/4"	3/8"	12015631	15
14544	1	11/32"	1/2"	8911473	25
20397*	6	10mm	13mm	12160858	15
20471	4	10mm	13mm	8905794	15
14545	1	13/32"	19/32"	8911497	25
14546	1	1/2"	11/16"	8911472	25
19851	5	1/2"	11/16"	12040983	15
14547	1	3/4"	1"	3816659	25
				8917320	
20665	7	19mm	24mm	12160374	15
16941	2	1"	1-9/32"	12015983	25

\*Gray Nylon

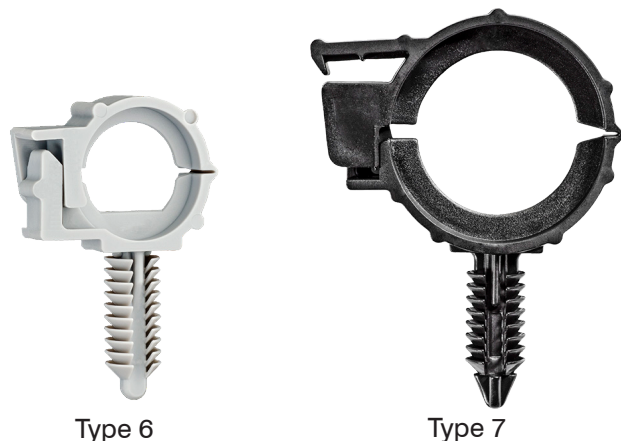



**8550**  
Black Nylon, 2-1/4" Long  
UNIT PACKAGE: 25



**8273**  
Black Nylon, 2-3/4" Long  
For 1/4" Hole in 115" Thick Metal  
UNIT PACKAGE: 50



**3690**  
*Photo not actual size*  
Natural Nylon, 3-1/2" Long  
UNIT PACKAGE: 100



**8272**  
Black Nylon, 2-3/4" Long  
For 1/4" Hole in .093" Thick Metal  
UNIT PACKAGE: 50

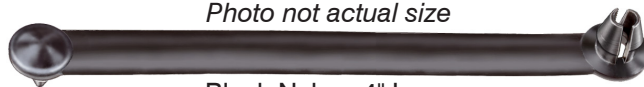

**9115**  
*Photo not actual size*  
Black Nylon, 4" Long  
UNIT PACKAGE: 50



**14376**  
(Mazda: 9928-90-753)  
Black Nylon, 110mm (4-3/8") Long, Releasable,  
Max. Bundle Diameter: 25mm (1"), Fits into 7mm Hole  
UNIT PACKAGE: 15



**20654**  
(Mercedes: 001-997-42-90)  
Black Nylon 120mm (4-3/4") Long,  
Fits into 8mm Hole  
UNIT PACKAGE: 10



**5879**  
Natural Nylon, 5" Long  
UNIT PACKAGE: 25



**14284**  
(Honda: 90669-671-000, 90669-671-003;  
Toyota: 90463-10337)  
Aqua Nylon, 110mm (5-5/16") Long, Max. Bundle Diameter: 23mm (7/8"), Fits into 6mm Hole  
UNIT PACKAGE: 15



**14298**  
(Honda: 90672-SA0-003; Mazda: 9928-91-053)  
Black Nylon, 140mm (5-1/2") Long, Releasable, Max. Bundle Dia: 30mm (1-5/32"), Fits into 7mm Hole  
UNIT PACKAGE: 25



**21203**  
Gray Nylon, 155mm (6-1/8") Long, Max. Bundle Dia: 30mm (1-3/16"), Fits into 6.3mm (1/4") Hole  
UNIT PACKAGE: 25

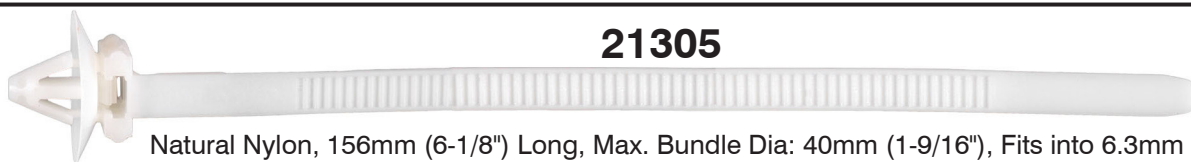

**21305**  
Natural Nylon, 156mm (6-1/8") Long, Max. Bundle Dia: 40mm (1-9/16"), Fits into 6.3mm (1/4") Hole  
UNIT PACKAGE: 25

# CABLE & HARNESS STRAPS

**20655**

(Mercedes: 114-997-02-90)



Black Nylon, 160mm (6-3/8") Long, Fits into 8mm (5/16") Hole

UNIT PACKAGE: 10

**21355**

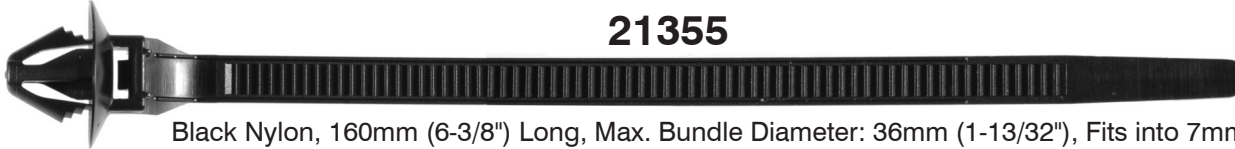

Black Nylon, 160mm (6-3/8") Long, Max. Bundle Diameter: 36mm (1-13/32"), Fits into 7mm Hole

UNIT PACKAGE: 25

**10649**

(GM: 3816659, 19130464)



Black Nylon, 6-1/2" Long

UNIT PACKAGE: 10

**21553**

(Toyota: 82711-12200) • *Photo not actual size*



Black Nylon, 170mm (6-3/4") Long, Max. Bundle Dia.: 40mm (1-9/16"), Fits into 13mm (1/2") Hole

UNIT PACKAGE: 25

**21310**

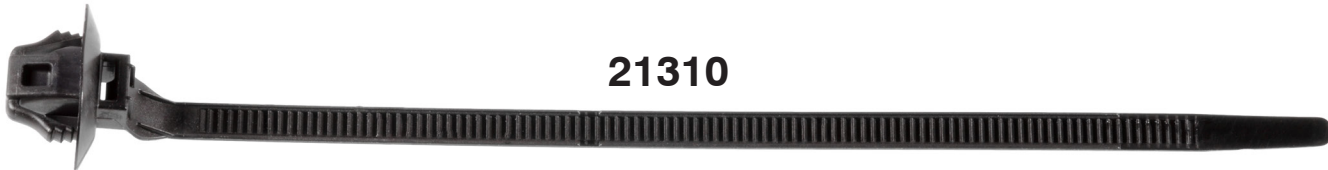

Black Nylon, 174MM (6-15/16") Long, Max. Bundle Diameter: 40mm (1-9/16"), Fits into 13mm (1/2") Hole

UNIT PACKAGE: 25

**20380**

*Photo not actual size*

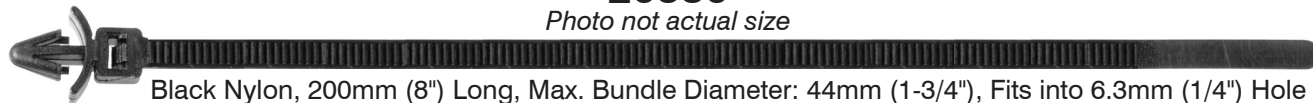

Black Nylon, 200mm (8") Long, Max. Bundle Diameter: 44mm (1-3/4"), Fits into 6.3mm (1/4") Hole

UNIT PACKAGE: 25

**21259**

(Nissan: 24225-89960)

*Photo not actual size*



Black Nylon, 200mm (8") Long, Max. Bundle Diameter: 55mm (2-3/16"), Fits into 8mm (5/16") Hole

UNIT PACKAGE: 25



# CABLE & HARNESS STRAPS

Photos not actual size

## Self-Clamping Natural Nylon Straps



Reusable

Auveco Part No.	Tensile Strength	Strap Length	Max Bundle Dia.	Width	Unit Pkg.
10217	18 lb.	3-7/8"	3/4"	3/32"	10
9637	50 lb.	14-7/8"	4"	3/16"	10
10218	120 lb.	14-1/2"	4"	9/32"	10

## Black Nylon Cable Ties Self Clamping



Auveco Part No.	Tensile Strength	Length	Width	Unit Pkg.
15144	18 lb.	4"	3/32"	100
15196	18 lb.	4"	3/32"	1000
15145	30 lb.	5-1/2"	1/8"	100
15197	30 lb.	5-1/2"	1/8"	1000
15146	50 lb.	7"	3/16"	50
15198	50 lb.	7"	3/16"	1000
15147	50 lb.	11"	3/16"	50
15199	50 lb.	11"	3/16"	500
15753	50 lb.	14"	3/16"	25
15148	120 lb.	14"	5/16"	25
15200	120 lb.	14"	5/16"	500

## Natural Nylon Cable Ties Self Clamping



Auveco Part No.	Tensile Strength	Length	Width	Unit Pkg.
11953	18 lb.	3"	3/32"	50
11954	18 lb.	4"	3/32"	50
14836	18 lb.	4"	3/32"	100
15188	18 lb.	4"	3/32"	1000
11955	30 lb.	5"	1/8"	50
14837	30 lb.	5"	1/8"	100
15189	30 lb.	5"	1/8"	1000
11956	50 lb.	7"	5/32"	25
14838	50 lb.	7"	5/32"	50
15190	50 lb.	7"	5/32"	1000
11957	50 lb.	11"	5/32"	25
14839	50 lb.	11"	5/32"	50
15191	50 lb.	11"	5/32"	500
15754	50 lb.	14"	5/32"	25
11958	120 lb.	14"	9/32"	10
14840	120 lb.	14"	9/32"	25
15192	120 lb.	14"	9/32"	500

## Black Nylon Cable Ties Self-Clamping with Mounting Hole



Auveco Part No.	Tensile Strength	Length	Screw Hole Size	Width	Unit Pkg.
15150	50 lb.	7-1/2"	#10	3/16"	50
15202	50 lb.	7-1/2"	#10	3/16"	250
15151	120 lb.	14-3/4"	#14	5/16"	25
15203	120 lb.	14-3/4"	#14	5/16"	200

## Natural Nylon Cable Ties Self-Clamping with Mounting Hole



Auveco Part No.	Tensile Strength	Length	Screw Hole Size	Width	Unit Pkg.
11961	50 lb.	7"	#10	5/32"	50
15194	50 lb.	7"	#10	5/32"	250
11963	120 lb.	13"	#14	9/32"	10



**14568**  
Cable Tie Tool



1. Feed Cable Tie in tool head, pull trigger to tension

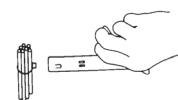

2. Hold trigger tension and twist tool 1/2 turn.

A light-weight, durable hand tool that's perfect for installing cable ties. The tool works on 18 pound, 30 pound, 40 pound, and 50 pound tensile rated cable ties. Length: 6-1/4". Made of rugged plastic.

UNIT PACKAGE: 1

## Cable Tie Mount with Adhesive

Uses a #6 flat head screw or 1/8" flat head rivet. Features a 4 way insertion and accepts 18, 30, and 50 pound cable ties. 1" x 1" Adhesive backing



**12361**  
Natural Nylon

UNIT PACKAGE: 10



**16001**  
Black Nylon

UNIT PACKAGE: 10



**Steel with Rubber Seal  
Oil Drain Plug Gaskets**

Auveco Part No.	I.D.	O.D.	Thick-ness	Unit Pkg.
<b>16026</b>	1/2"	1"	3/64"	5
<b>18299</b>	14mm	25mm	1mm	10
<b>18931</b>	16mm	24mm	2mm	10
<b>18932</b>	18mm	27mm	2mm	10



**Oil Drain Plug  
Rubber Gaskets**

**21180**

I.D.: 11mm  
O.D.: 18mm  
Replacement Gasket  
For Auveco No. 20347  
Ford 1993 - On

UNIT PACKAGE: 10

**21179**

I.D.: 11mm  
O.D.: 19mm  
Replacement Gasket  
For Auveco No. 21047  
GM 1985 - On

UNIT PACKAGE: 10

**18665**

I.D.: 11mm  
O.D.: 21mm  
Replacement Gasket  
For Auveco 18663  
18664 & 20372  
GM 12mm-1.75

UNIT PACKAGE: 10

**19630**

I.D.: 11mm  
O.D.: 25mm  
Replacement Gasket  
For Auveco 18023  
GM 12mm-1.75

UNIT PACKAGE: 10

**20896**

(Not Supplied by O.E.M.)

I.D.: 13mm  
O.D.: 19mm  
Replacement Gasket  
For Auveco No.  
19773  
M14-1.5

UNIT PACKAGE: 10

**20453**

(F5TZ-6734-BA)

I.D.: 13mm  
O.D.: 22mm  
Replacement Gasket  
For Auveco No.  
19279 & 21354  
M14-1.5

UNIT PACKAGE: 10



**22169**

(Not Supplied by O.E.M.)

I.D.: 18mm  
O.D.: 23mm  
Replacement Gasket for Auveco 21650  
Chevrolet Cruze & Volt 2010 - On

UNIT PACKAGE: 10



**22134**

(Toyota: 90430-12031, 90430-12018,  
90430-12027 & 90430-C0005)  
Fibre & Aluminum

Oil & Transmission  
Drain Plug Gasket  
Inner Diameter: 12mm  
Outer Diameter: 21mm  
Thickness: 1.75mm

Toyota 4Runner, Avalon, Camry, Celica, Corolla, Echo,  
FJ Cruiser, Highlander, Land Cruiser, Matrix, MR2,  
Paseo, Previa, Prius, RAV4, Sequoia, Sienna, Solara,  
Supra, T100, Tacoma, Tercel, Tundra, Venza & Yaris  
1991 - On

UNIT PACKAGE: 5

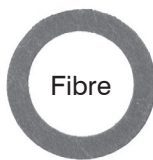

Fibre

**Oil Drain  
Plug Gaskets**

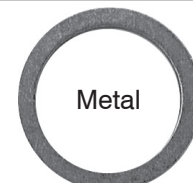

Metal

Auveco Part No.	I.D.	O.D.	Thick-ness	Mat.	Unit Pkg.
<b>19538</b>	1/2"	3/4"	5/64"	Bk Fibre	50
<b>8277</b>	1/2"	3/4"	3/32"	Nylon	25
<b>15918</b>	1/2"	7/8"	1/16"	Copper	25
<b>19590</b>	1/2"	7/8"	1/16"	Aluminum	25
<b>16996</b>	1/2"	15/16"	1/16"	Nylon	25
<b>18019</b>	1/2"	15/16"	5/64"	Fibre	50
<b>19539</b>	9/16"	13/16"	5/64"	BK. Fibre	50
<b>8281</b>	9/16"	13/16"	3/32"	Nylon	25
<b>15919</b>	9/16"	13/16"	3/32"	Copper	25
<b>8278</b>	5/8"	1"	3/32"	Nylon	25
<b>18021</b>	3/4"	1"	1/16"	Copper	25
<b>8279</b>	3/4"	1-1/16"	3/32"	Nylon	25
<b>18849</b>	12mm	21mm	1.8mm	Steel*	5
<b>16680</b>	12mm	22mm	1.5mm	Nylon	50
<b>19591</b>	12mm	22mm	1.5mm	Copper	15
<b>19601</b>	12mm	22mm	1.5mm	Aluminum	50
<b>18726</b>	12mm	22mm	2mm	Bk Fibre	50
<b>19621</b>	14mm	20mm	1mm	Aluminum	50
<b>20454</b>	14mm	20mm	1.5mm	Copper	15
<b>19592</b>	14mm	22mm	1.5mm	Copper	15
<b>16956</b>	14mm	22mm	2mm	Aluminum	50
<b>16681</b>	14mm	24mm	1.5mm	Nylon	50
<b>16682</b>	14mm	24mm	2mm	Bk Fibre	50
<b>19604</b>	16mm	22mm	1.5mm	Copper	10
<b>19603</b>	16.4mm	27mm	2mm	Bk Fibre	50
<b>16683</b>	16.5mm	27mm	1.5mm	Nylon	50
<b>20462</b>	18mm	24mm	1.2mm	Aluminum	25
<b>16955</b>	18mm	25.5mm	2mm	Aluminum	50
<b>16684</b>	18mm	29mm	1.5mm	Nylon	50
<b>19605</b>	18mm	26mm	1.5mm	Copper	10
<b>18829</b>	18mm	29mm	1.5mm	Grn Fibre	25
<b>16685</b>	20mm	28mm	1.5mm	Nylon	50
<b>19593</b>	20mm	25mm	1.6mm	Copper	10
<b>18830</b>	20mm	28mm	1.5mm	Grn Fibre	25
<b>21647</b>	20mm	28mm	2mm	Bk Fibre	25
<b>21178</b>	20mm	28.5mm	1.6mm	Aluminum	25
<b>21648</b>	23mm	29mm	2mm	Bk Fibre	25
<b>21649</b>	24mm	30mm	1.8mm	Aluminum	10
<b>18020</b>	25.5mm	35mm	2mm	Bk Fibre	50

\* Teflon coated steel



## Oil Drain Plug Crushable Gaskets



Auveco Part No.	Inner Diameter	Outer Diameter	Thickness	Material	Unit Pkg.
<b>19545</b>	1/2"	3/4"	5/64"	Copper	10
<b>17261</b>	12mm	18mm	2mm	Copper	10
<b>21258</b>	12mm	18mm	3mm	Copper	10
<b>19007</b>	14mm	19mm	2mm	Steel	10
<b>17262</b>	14mm	20mm	2mm	Copper	10
<b>22223</b>	14mm	22mm	2mm	Copper	10
<b>21677</b>	16mm	21mm	2.5mm	Steel	10
<b>17263</b>	16mm	22mm	2mm	Copper	10
<b>17264</b>	18mm	24mm	2mm	Copper	10
<b>21116</b>	18mm	24mm	2.5mm	Steel	10
<b>17265</b>	20mm	26mm	2mm	Copper	10
<b>19139</b>	20mm	26mm	2mm	Steel	15

## OIL & TRANSMISSION DRAIN PLUGS WITH GASKETS



**14196**

Zinc

Thread: 1/2"-20  
Hex: 7/8"  
Length Under Head: 1/2"

Fits the following 1/2"-20 applications:

**AMC:** 6 & 8 Cylinder All 64-On

**Buick:** 4, 6 & 8 Cylinder All [Exc. 2.5 (151), 3.0, 4.3, 4.9 (301 Eng.)] 59-On

**Cadillac:** 6 & 8 Cylinder All (Exc. 4.1 Eng) 66-On

**Chevrolet** (Includes Light Truck): 4, 6 & 8 Cylinder All [Exc. 1.8 (diesel), 2.5 (151), 4.3 (diesel) Eng.] 28-On

**Chrysler Corp.:** 6 & 8 Cylinder All 62-On

**Ford Motor Co.:** 4, 6 & 8 Cylinder All (Exc. 98, 122, 140, 171 Eng) 57-On

**GMC** (Light Truck): 6 & 8 Cylinder All 39-On

**Oldsmobile:** 4, 6 & 8 Cylinder All [Exc. 2.5 (151), 3.0, 4.3, (diesel), 4.3S, 4.9T (301)] 61-On

**Pontiac:** 4, 6, & 8 Cylinder All [Exc. 1.8 (diesel), 2.5 (151), 4.3 (diesel), 4.3S, 4.9T (301)] 60-On

UNIT PACKAGE: 10



**19130**

(3921988)  
Phosphate

Thread: 1/2"-20  
Hex: 9/16"  
Length Under Head: 13/16"  
Washer Head O.D.: 7/8"

Fits the following applications:

**Buick:** 4, 6 & 8 Cylinder All [Exc. 2.5(151) 3.0, 4.3, 4.9 (301 Eng.)] 59-On

**Cadillac:** 6 & 8 Cylinder All (Exc. 4.1 Eng) 66-On

**Chevrolet** (Inc. GMC Light Truck): 4, 6 & 8 Cylinder All [Exc. 1.8 (diesel), 2.5 (151), 4.3 (diesel) Eng.] 28-On

**Oldsmobile:** 4, 6 & 8 Cylinder All [Exc. 1.8 (diesel), 2.5 (151), 3.0, 4.3, (diesel), 4.3S, 4.9T (301)Eng.] 61-On

**Pontiac:** 4, 6 & 8 Cylinder All [Exc. 1.8 (diesel), 2.5 (151), 4.3 (diesel), 4.3S, 4.9T (301)Eng.] 60-On

UNIT PACKAGE: 15



**18373**

(6034376)

Plain with Rubber  
Washer Face Gasket

Thread: 1/2"-20  
Hex: 5/8"  
Length Under Head: 13/16"  
Rubber Gasket O.D.: 1-3/32"

Fits the following applications:

**Chrysler**

UNIT PACKAGE: 2

## Sec. 13

# OIL & TRANSMISSION DRAIN PLUGS WITH GASKETS



**18022**  
(948187-0)  
Zinc

Thread: 3/4"-16  
Hex: 1"  
Length Under Head: 1/2"

Fits the following applications:  
**Volvo:** 4 Cylinder

UNIT PACKAGE: 2



**21665**  
(BC3Z-6730-A)  
Yellow Plastic with  
Rubber Gasket

Diameter: 13/16"  
Square Drive: 3/8"  
Overall Length: 1-13/16"

Fits the following applications:  
**Ford:** F250 & F350 with 6.7L  
PowerStroke 2011 - On

UNIT PACKAGE: 1



**22143**  
(VW: 06L-103-801)  
Black Plastic

Plastic Oil Drain Plug  
Head Diameter: 23mm  
(with Screw Driver Slot)  
Overall Height: 20mm  
With Installed Rubber O-Ring

Fits the following applications:  
**Audi:** A3 & S3 and Volkswagen Golf & GTI 2015 - On

UNIT PACKAGE: 1



**19318**  
(Jeep: 83504041;  
Lexus: 90341-10006, 90341-10012)  
Zinc & Yellow

Thread: M10-1.5; Hex: 14mm  
Length Under Head: 9mm

Fits the following transmission applications:  
**Jeep:** Cherokee, Comanche & XJ 1991-On  
**Lexus:** GS300, LS400 & SC400 1991-On

UNIT PACKAGE: 2



**20807**  
(F81Z-6730-AA)  
Plain with Rubber  
Washer Face Gasket

Thread: M10-1.5  
Hex: 13mm  
Length Under Head: 15mm  
Rubber Gasket O.D.: 28mm

Fits the following 4R100 transmission applications:  
**Ford:** E150-450, F150-450 Excursion &  
Expedition 1980 - On

UNIT PACKAGE: 1



**15527**  
Zinc

Thread M12-1.25  
Hex: 14mm  
Length Under Head: 11mm  
Washer Head O.D.: 20mm

Fits the following M12-1.25 applications:  
**Nissan:** Sentra, Stanza & Pulsar with FWD 1982-On

UNIT PACKAGE: 5



**19589**  
Zinc

Thread M12-1.5  
Hex: 13mm  
Length Under Head: 12mm  
Washer Head O.D.: 17mm

Fits the following applications:  
**BMW & Mercedes**

UNIT PACKAGE: 5



**21293**  
(11128-01M0B)  
Zinc & Yellow

Thread: M12-1.25  
Hex: 14mm  
Length Under Head: 12mm  
Washer Head O.D.: 23mm

Fits the following applications:  
**Nissan** Sentra & 350Z and Infiniti 1992 - On

UNIT PACKAGE: 2



**19588**  
Zinc

Thread: M12-1.25  
Hex: 14mm  
Length Under Head: 17mm  
Washer Head O.D.: 20mm

Fits the following applications:  
**Nissan**

UNIT PACKAGE: 5



**18023**  
(21006725)  
Black Zinc  
With Rubber Gasket

Thread: M12-1.75  
Hex: 14mm  
Length Under Head: 19mm  
Rubber Gasket O.D.: 31mm

Fits the following application:  
**GM:** Saturn

UNIT PACKAGE: 2



**21093**

(24233099)  
Zinc with  
Rubber Gasket

Thread: M12-1.75  
Hex: 15mm  
Length Under Head: 20mm  
Washer Head O.D.: 32mm

Fits the following applications:  
4L80-E Transmissions on **Chevrolet** 2 WD Full Size  
Vans & Pickup Trucks 1997 - On

UNIT PACKAGE: 2

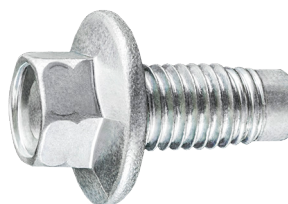

**21047**

(GM: 3536964, 3538469,  
11519408,  
11562588, 24100042;  
Isuzu: 8-11519-408-0)  
Zinc with Rubber Gasket

Thread: M12-1.75  
Hex: 15mm  
Length Under Head: 25mm  
Washer Head O.D.: 26mm

Fits the following applications:  
**GM:** 2.2 (4), 3.1 (M), 3.8 (K), 3.8 (1), 2.3, 4.9 & 6.0L  
Eng. 1985 - On

UNIT PACKAGE: 2



**18374**

(F5AZ-6730)  
Plain With Rubber  
Washer Face Gasket

Thread: M12-1.75  
Hex: 15mm  
Length Under Head: 21mm  
Rubber Gasket O.D.: 28mm

Fits the following applications:  
**Ford:** 2.5, 3.0 & 4.6 Eng. with Modular  
& Aluminum Pans

UNIT PACKAGE: 2

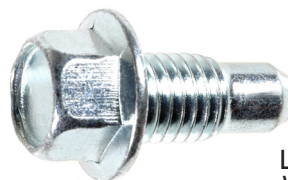

**14677**

Zinc

Thread: M12-1.75  
Hex: 15mm  
Length Under Head: 26mm  
Washer Head O.D.: 22mm

Fits the following M12-1.75 applications:  
**Buick:** 4 Cylinder 151 (2.5) Eng. 80-On  
6 Cylinder 3.0, 4.3 (Diesel) Eng. 82-On  
8 Cylinder 4.3, 4.9 Eng. 81-77

**Cadillac:** 8 Cylinder 4.1 Eng. 82-On

**Chevrolet:** 4 Cylinder 151 (2.5) Eng. 78-On  
6 Cylinder 4.3 (Diesel) Eng. 82-On

**Oldsmobile:** 4 Cylinder 151 (2.5) Eng. 78-On  
6 Cylinder 3.0, 4.3 (Diesel) Eng. 82-On  
8 Cylinder 4.3S, 4.9T (301) Eng. 80-79

**Pontiac:** 4 Cylinder 151 (2.5) Eng. 77-On  
6 Cylinder 4.3 (Diesel) Eng. 82-On  
8 Cylinder 4.3S, 4.9T (301) Eng. 81-77

UNIT PACKAGE: 5



**21354**

(6507741-AA)  
Zinc with  
Rubber Gasket

Thread: M14-1.5  
Hex: 13mm  
Length Under Head: 21mm  
Washer Head O.D.: 29mm

Fits the following application:  
**Chrysler**

UNIT PACKAGE: 2



**21353**

(90009-PH1-000)  
Zinc & Yellow

Thread: M14-1.5  
Hex: 17mm  
Length Under Head: 10mm  
Washer Head: 24mm

Fits the following applications:  
**Acura & Honda**

UNIT PACKAGE: 5

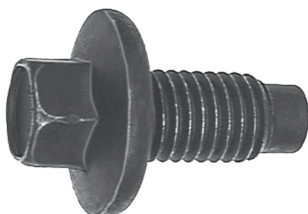

**20347**

(YS4Z-6730AA)  
Plain with  
Rubber Gasket

Thread: M12-1.75  
Hex: 13mm  
Length Under Head: 25mm  
Washer Head O.D.: 26mm

Fits the following applications:  
**Ford** 1999 - 93

UNIT PACKAGE: 2



**21352**

(N90288901)  
Black Zinc

Thread: M14-1.5  
Hex: 19mm  
Length Under Head: 14mm

Fits the following applications:  
**Volkswagen**

UNIT PACKAGE: 2

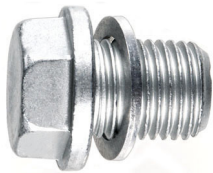
**Sec. 13****OIL & TRANSMISSION DRAIN PLUGS WITH GASKETS****21135**(21512-23001)  
DacrometThread: M14-1.5  
Hex: 17mm  
Length Under Head: 17mm  
Washer Head O.D.: 22.5mm

Fits the following applications:

**Hyundai & Kia** 1995 - On

UNIT PACKAGE: 2

**18024**

Zinc

Thread: M14-1.25  
Hex: 13mm  
Length Under Head: 16mm  
Washer Head O.D.: 23mm

Fits the following applications:

**Jeep**

UNIT PACKAGE: 5

**16308**

Zinc

Thread: M14-1.5  
Hex: 16mm  
Length Under Head: 11mm  
Washer Head O.D.: 25mm

Fits the following M14-1.5 applications:

**Chrysler Imports:** 83-On**Honda:** 83-On**Isuzu:** 87-On**Mazda:** 72-On**Spectrum:** 88-On**Sprint:** 88-On**VW-Audi:** 74-On

UNIT PACKAGE: 5

**21798**(VW: N91167901)  
ZincOil Drain Plug with Gasket  
Thread: M14-1.5  
T-50 Torx® Drive  
Length Under Head: 12mm  
Head O.D.: 19mm

Fits the following M14-1.5 applications:

**Audi:** A3, A4 Quattro, A5 Quattro, A6, A6 Quattro,  
All Road Quattro & Q5**VW:** Beetle Turbo, CC Lux, Eos Executive, Eos  
Komfort, Eos Sport, GTI, Jetta GLI, Tiguan S, Tiguan  
SE & Tiguan SEL 2007 - On

UNIT PACKAGE: 2

**20426**(90009-PY3-000)  
Zinc & Yellow  
with Aluminum GasketThread: M14-1.5  
Hex: 17mm  
Length Under Head: 15mm  
Washer Head O.D.: 24mm

Fits the following M14-1.5 applications:

**Acura & Honda:** 2000 - On

UNIT PACKAGE: 5

**21650**(55568037)  
ZincThread: M14-1.5  
Hex: 10mm  
Length Under Head: 16mm  
Washer Head O.D.: 27mm

Fits the following applications:

**Chevrolet:** Cruze & Volt 2010 - On

UNIT PACKAGE: 2

**18025**(E9DZ-6730-B)  
ZincThread: M14-1.5  
Hex 13mm  
Length Under Head: 16mm  
Washer Head O.D.: 23mm

Fits the following applications:

**Ford:** Escort

UNIT PACKAGE: 5

**22196**(Mazda: FS50-21-249 - Drain Plug,  
9956-41-400 - Gasket)  
ZincOil Drain Plug with Gasket  
Thread: M14-1.5  
Drive: 8mm Allen  
Head Diameter: 22mm  
Length Under Head: 16mm

Fits the following applications:

**Mazda:** 3, 6 & CX-5 2012 - On; RX-8 2011 - 09

UNIT PACKAGE: 2



**22205**  
(Honda: 90009-R70-A00)  
Zinc  
Oil Drain Plug with Gasket  
Thread: M14-1.5  
Hex: 17mm  
Length Under Head: 18mm  
Washer Head O.D.: 24.5mm

Fits the following applications  
**Honda:** Accord 1999 - On; Civic 2014 - On

UNIT PACKAGE: 5



**19773**  
(F75Z-6730-BA)  
Phosphate with Rubber Gasket  
Thread: M14-1.5  
Hex: 16mm  
Length Under Head: 20mm  
Washer Head O.D.: 28mm

Fits the following applications:  
**Ford Vans & Trucks** with 6.8L Eng. 2000-96

UNIT PACKAGE: 1



**18375**  
(6503433)  
Plain with Rubber Washer Face Gasket  
Thread: M14-1.50  
Hex: 17mm  
Length Under Head: 18mm  
Rubber Gasket O.D.: 28mm

Fits the following applications:  
**Chrysler** 1.5 & 2.0 Eng.

UNIT PACKAGE: 2



**19279**  
(F6TZ-6730BA)  
Phosphate with Rubber Gasket  
Thread M14-1.50  
Hex: 13mm  
Length Under Head: 20mm  
Washer Head O.D.: 28mm

Fits the following applications:  
**Chrysler:** with 2.0(F), 2.4(B,G,8), 2.7(R,T), 3.3(G,S,3) & 3.5(G,4) Eng. 2000 - On

**Ford:** Aerostar, Explorer & Ranger 6 Cylinder 4 Ltr. Eng. 1996-On

UNIT PACKAGE: 2

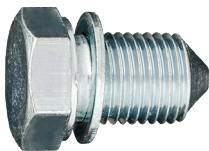

**20746**  
(N90813201)  
Zinc with Sems® Gasket  
Thread: M14-1.5  
Hex: 19mm  
Length Under Head: 20mm  
Sems® Washer O.D.: 20mm

Fits the following applications:  
**Audi** Cabriolet & Quattro with 1.8,1.9, 2.0, 2.7, 2.8, & 3.0 Eng.

**VW** Beetle, Eurovan, Golf, Jetta, Passat & Touareg with 1.8, 1.9, 2.0, 2.8, 3.2 & 4.0 Eng.

UNIT PACKAGE: 2



**14678**  
Zinc  
Thread: M14-1.5  
Hex: 16mm  
Length Under Head: 20mm  
Washer Head O.D.: 25mm

Fits the following M14-1.5 applications:  
**AMC:** 4 Cylinder VW 121 Eng. 79-77

**Chevrolet:** 4 Cylinder 1.8 (Diesel) Eng. 81-On

**Chrysler Corp.** (Exc. Imports): 4 Cylinder All 78-On

**Chrysler Corp. Imports:** 4 Cylinder All 83-On  
4 Cylinder K & W Engines (built after 10-81) 82

**Ford Motor Co.:** 4 & 6 Cylinder 98, 122, 140, 171 Eng. 73-On

**Honda:** 4 Cylinder Prelude 83-On

**Mazda:** 4 Cylinder All 72-On

**Pontiac:** 4 Cylinder 1.8 (Diesel) 83-On

**Volkswagen:** 4 Cylinder All (Water Cooled Engine) 74-On

UNIT PACKAGE: 5



**19141**  
(6504018)  
Plain with Rubber Washer Face Gasket  
Thread: M14-1.50  
Hex: 13mm  
Length Under Head: 20mm  
Rubber Gasket O.D.: 28mm

Fits the following applications:  
**Chrysler** 2.0, 2.4, 2.7, 3.2, 3.5, 3.7 & 4.7 Eng. 2000 - On

UNIT PACKAGE: 2



**18026**  
(601-997-02-30)  
Zinc

Thread: M14-1.5  
Hex: 13mm  
Length Under Head: 24mm  
Washer Head O.D.: 19mm

Fits the following applications:  
**Mercedes:** 300 Series

UNIT PACKAGE: 2



**21326**  
(Subaru: 807016160, 803916010;  
Toyota: SU003-02194)  
Zinc

Thread: M16-1.5 x 9mm  
Hex 14mm  
Washer Head O.D.: 24mm

Fits the following applications:  
**Subaru:** Legacy & Outback 2.5L

**Scion:** FR-S 2.0L 2013

UNIT PACKAGE: 2



**15528**  
Zinc

Thread: M16.4-1.33 O.S.  
Hex: 19mm  
Length Under Head: 13mm  
Washer Head O.D.: 26mm

Fits the following M16.4 O.S. applications:  
**Nissan:** All (Exc. Sentra, Stanza & Pulsar with FWD 62-On)

**Renault:** Fuego & Le Car 80-On

UNIT PACKAGE: 5



**15529**  
Zinc

Thread: M18-1.5  
Hex: 19mm  
Length Under Head: 12mm  
Washer Head O.D.: 29mm

Fits the following M18-1.5 applications:  
**Chrysler:** All imports 70-On

**Renault:** Le Car 79-76

**Toyota:** All 75-On

UNIT PACKAGE: 5



**15530**  
Zinc

Thread: M20-1.5  
Hex: 17mm  
Length Under Head: 15mm  
Washer Head O.D.: 27mm

Fits the following M20-1.5 applications:  
**Chevrolet Truck:** Luv 82-75

**Honda:** All exc. Prelude 73-On

**Subaru:** All 79-On

UNIT PACKAGE: 5



**21041**  
(028-103-059-A)  
Zinc

Thread: M24-1.5  
Drive: 10mm Allen  
Length Under Head: 10mm  
Head Diameter: 32mm

Fits the following applications:  
**Audi:** Cabriolet, A6, A8, Avant, Quattro, RS6, S4, S6 & S8

**VW:** Phaeton 6.0L & V8 4.2L and Touareg 4.2L

UNIT PACKAGE: 1



**22344**  
(BMW: 11-13-7-605-018)  
Black Plastic



Plastic Oil Drain Plug  
With Rubber Gasket  
Thread: M24-1.5 x 11mm  
Top Head Diameter: 36mm  
Internal Hex Drive: 10mm

Fits the following applications:  
**BMW:** 228i, 320i, 328i, 428i, 528i, X1 & Z4 2014 - On

UNIT PACKAGE: 1



**18027**  
Zinc

Thread: M25-1.5  
Hex: 24mm  
Length Under Head: 13mm  
Washer Head O.D.: 35mm

Fits the following applications:  
**Toyota**

UNIT PACKAGE: 1



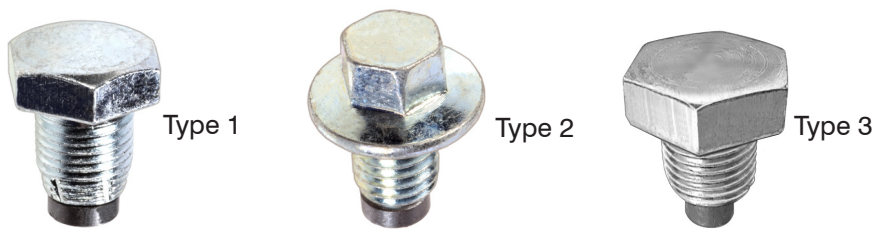

**Magnetic Oil Drain Plugs with Gaskets**  
Zinc Plated

Auveco Part No.	Type	Thread Size	Hex	Length Under Head	Finish	Unit Pkg.
<b>19365</b>	3	1/2"-20	3/4"	43/64"	Zinc	1
<b>17145</b>	1	1/2"-20 Single Oversize	3/4"	13/16"	Zinc	2
<b>17146</b>	1	1/2"-20 Double Oversize	3/4"	13/16"	Zinc & Yellow	2
<b>17147</b>	1	1/2"-20 Triple Oversize	3/4"	13/16"	Black Zinc	2
<b>17148</b>	2	12mm-1.75	13mm	19mm	Zinc	2

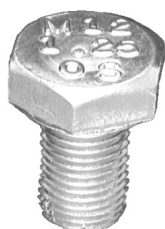

Metric

**Oversize Oil Pan Drain Plugs with Fibre Gaskets**  
Self-Tapping



Standard

Auveco Part No.	Size	Finish	Unit Pkg.
<b>19587</b>	1/2"-20, Single Oversize	Zinc	5
<b>18121</b>	1/2"-20, Double Oversize	Zinc & Yellow	5
<b>18122</b>	1/2"-20, Triple Oversize	Black Zinc	5
<b>8285</b>	5/8"-18, Single Oversize	Zinc	5
<b>8286</b>	11/16"-20, Single Oversize	Zinc	5
<b>8288</b>	3/4"-16, Single Oversize	Zinc	5
<b>8289</b>	7/8"-14, Single Oversize	Zinc	5
<b>19618</b>	M12-1.25, Single Oversize	Zinc	5
<b>20759</b>	M12-1.50, Single Oversize	Zinc	5
<b>19619</b>	M12-1.75, Single Oversize	Zinc	5
<b>19620</b>	M14-1.50, Single Oversize	Zinc	5

## Oversize "Piggy-Back" Drain Plugs with Gasket



**11782**  
Zinc

1/2"-20 Single Oversize  
UNIT PACKAGE: 5



**11783**  
Zinc & Yellow

1/2"-20 Double Oversize  
UNIT PACKAGE: 5

Also available in Large Bulk Quantities



Ref. No: **1792**

1/4"-28, Straight  
Thread Length: 9/64"  
Overall Length: 1/2"  
Ball Check, Plated

**15055** Unit Pkg: 50  
**15074** Unit Pkg: 250  
**15075** Unit Pkg: 500  
**15440** Unit Pkg: 1000



Ref. No. **1952**

1/4" Drive Fit, Straight  
Overall Length: 27/64"  
No Check Valve, Plated

**15065** Unit Pkg: 50  
**15094** Unit Pkg: 250  
**15450** Unit Pkg: 1000



Ref. No: **5530**

1/4"-28, Straight  
Self-Tapping  
Overall Length: 9/16"  
Ball Check, Plated

**15000** Unit Pkg: 50  
**15068** Unit Pkg: 250  
**15069** Unit Pkg: 500

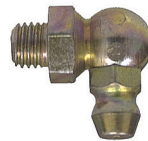

Ref. No: **1911**

1/4"-28, 90°  
Overall Length: 45/64"  
Ball Check, Plated

**9261** Unit Pkg: 25  
**15108** Unit Pkg: 100  
**15109** Unit Pkg: 250

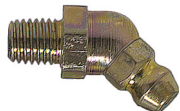

Ref. No: **1636**

1/4"-28, 45°  
Thread Length: .3"  
Overall Length: 1"  
Ball Check, Plated

**15056** Unit Pkg: 25  
**15076** Unit Pkg: 100  
**15077** Unit Pkg: 250

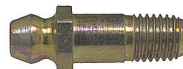

Ref. No. **1680**

1/4"-28, Straight  
Overall Length: 15/16"  
Ball Check, Plated

**9259** Unit Pkg: 25  
**15104** Unit Pkg: 100  
**15417** Unit Pkg: 1000



Ref. No: **1641**

1/4"-28, Straight  
Thread Length: 7/32"  
Overall Length: 9/16"  
Ball Check, Plated

**9257** Unit Pkg: 50  
**15100** Unit Pkg: 250  
**15101** Unit Pkg: 500  
**15415** Unit Pkg: 1000

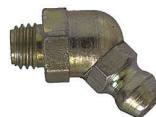

Ref. No: **1637**

1/4"-28, 45°  
Overall Length: 29/32"  
Ball Check, Plated

**9260** Unit Pkg: 25  
**15106** Unit Pkg: 100  
**15107** Unit Pkg: 250  
**15418** Unit Pkg: 1000



Ref. No: **1743**

1/4" Drive Fit, Straight  
Overall Length: 1/2"  
Ball Check, Plated

**15054** Unit Pkg: 25  
**15072** Unit Pkg: 100  
**15073** Unit Pkg: 250  
**15439** Unit Pkg: 1000



Ref No: **5590**

1/4"-28, 90°  
Self-Tapping  
Overall Length: 43/64"  
Ball Check, Plated

**19176** Unit Pkg. 25  
**19177** Unit Pkg. 100  
**19178** Unit Pkg. 250

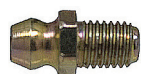

Ref. No: **1652**

1/4"-28 Straight  
Overall Length: 11/16"  
Ball Check, Plated

**9258** Unit Pkg: 50  
**15102** Unit Pkg: 250  
**15103** Unit Pkg: 500  
**15416** Unit Pkg: 1000



Ref No: **1610**

1/8" Pipe, Straight  
Overall Length: 5/8"  
Ball Check, Plated

**9262** Unit Pkg: 50  
**15110** Unit Pkg: 250  
**15111** Unit Pkg: 500  
**15420** Unit Pkg: 1000

# GREASE FITTINGS

Also available in Large Bulk Quantities

**Sec. 13**

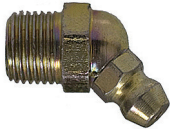

Ref. No: **1688**

1/8" Pipe, 45°  
Overall Length: 1"  
Ball Check, Plated

**9264** Unit Pkg: 25  
**15114** Unit Pkg: 100  
**15115** Unit Pkg: 250  
**15422** Unit Pkg: 1000

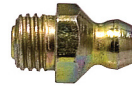

Ref. No: **1711**

5/16"-24, Straight  
Overall Length: 5/8"  
Ball Check, Plated

**15057** Unit Pkg: 25  
**15078** Unit Pkg: 100  
**15079** Unit Pkg: 250

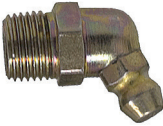

Ref. No: **1612**

1/8" Pipe, 65°  
Overall Length: 7/8"  
Ball Check, Plated

**9265** Unit Pkg: 25  
**15116** Unit Pkg: 100  
**15117** Unit Pkg: 250  
**15423** Unit Pkg: 1000



Ref. No: **1608**

5/16" Drive Fit, Straight  
Overall Length: 9/16"  
Ball Check, Plated

**15061** Unit Pkg: 50  
**15086** Unit Pkg: 250  
**15087** Unit Pkg: 500  
**15446** Unit Pkg: 1000

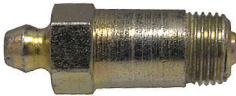

Ref No: **1607**

1/8" Pipe, Straight  
Overall Length: 1-1/4"  
Ball Check, Plated

**9267** Unit Pkg: 25  
**15120** Unit Pkg: 100  
**15121** Unit Pkg: 250



Ref. No: **1710**

3/8"-24, Straight  
Overall Length: 5/8"  
Ball Check, Plated

**15058** Unit Pkg: 25  
**15080** Unit Pkg: 100

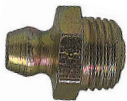

Ref. No: **5570**

1/8" Pipe, Straight  
Self-Tapping  
Overall Length: 39/64"  
Nominal Hole Size: 3/8"  
Ball Check, Plated

**15066** Unit Pkg: 25  
**15096** Unit Pkg: 100  
**15097** Unit Pkg: 250

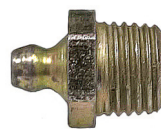

Ref. No: **1627**

1/4" Pipe, Straight  
Overall Length: 27/32"  
Ball Check, Plated

**15059** Unit Pkg: 25  
**15082** Unit Pkg: 100  
**15083** Unit Pkg: 250  
**15444** Unit Pkg: 1000

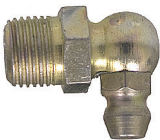

Ref. No: **1613**

1/8" Pipe, 90°  
Overall Length: 53/64"  
Ball Check, Plated

**9266** Unit Pkg: 25  
**15118** Unit Pkg: 100  
**15119** Unit Pkg: 250  
**15424** Unit Pkg: 1000

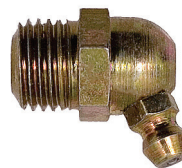

Ref. No: **1629**

1/4" Pipe, 65°  
Overall Length: 1"  
Ball Check, Plated

**15062** Unit Pkg: 10  
**15088** Unit Pkg: 50  
**15089** Unit Pkg: 100



Ref. No: **1728**

3/16" Drive Fit, Straight  
Overall Length: 1/2"  
Ball Check, Plated

**15060** Unit Pkg: 50  
**15084** Unit Pkg: 250  
**15085** Unit Pkg: 500

**Email your product suggestions to**

**mail@auveco.com**

# Sec. 13

# METRIC GREASE FITTINGS

Also available in Large Bulk Quantities



Ref No: **8601**

6mm-1.00, Straight  
DIN 71412  
Overall Length: 14mm  
Ball Check, Plated

**11097** Unit Pkg: 5  
**15122** Unit Pkg: 50  
**15123** Unit Pkg: 100  
**15426** Unit Pkg: 1000



Ref. No: **7045**

6mm-1.00, 45°  
Overall Length: 22mm  
Ball Check, Plated

**11775** Unit Pkg: 10  
**15132** Unit Pkg: 50  
**15133** Unit Pkg: 100  
**15431** Unit Pkg: 1000



Ref No: **7090**

6mm-1.00, 90°  
Overall Length: 18mm  
Ball Check, Plated

**11776** Unit Pkg: 10  
**15134** Unit Pkg: 50  
**15135** Unit Pkg: 100



Ref No: **8901**

8mm-1.00, Straight  
DIN 71412  
Overall Length: 15mm  
Ball Check, Plated

**11098** Unit Pkg: 5  
**15124** Unit Pkg: 50  
**15125** Unit Pkg: 100

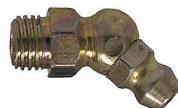

Ref No: **7445**

8mm-1.00, 45°  
Overall Length: 23mm  
Ball Check, Plated

**11777** Unit Pkg: 10  
**15136** Unit Pkg: 50  
**15137** Unit Pkg: 100

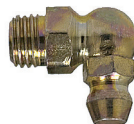

Ref No: **7490**

8mm-1.00, 90°  
DIN 71412  
Overall Length: 18mm  
Ball Check, Plated

**11099** Unit Pkg: 5  
**15126** Unit Pkg: 50  
**15127** Unit Pkg: 100



Ref No: **9201**

8mm-1.25, Straight  
Overall Length: 15mm  
Ball Check, Plated

**11778** Unit Pkg: 10  
**15138** Unit Pkg: 50  
**15139** Unit Pkg: 100  
**15434** Unit Pkg: 1000



Ref No: **7545**

8mm-1.25, 45°  
Overall Length: 23mm  
Ball Check, Plated

**11779** Unit Pkg: 10  
**15140** Unit Pkg: 50  
**15141** Unit Pkg: 100



Ref No: **7590**

8mm-1.25, 90°  
Overall Length: 18mm  
Ball Check, Plated

**11780** Unit Pkg: 10  
**15142** Unit Pkg: 50  
**15143** Unit Pkg: 100



Ref No: **9301**

10mm-1.00, Straight  
DIN71412  
Overall Length: 15mm  
Ball Check, Plated

**11100** Unit Pkg: 5  
**15128** Unit Pkg: 50  
**15129** Unit Pkg: 100

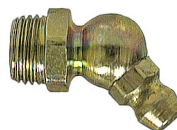

Ref No: **9345**

10mm-1.00, 45°  
Overall Length: 23mm  
Ball Check, Plated

**15067** Unit Pkg: 25  
**15098** Unit Pkg: 100  
**15099** Unit Pkg: 250



Ref No: **9390**

10mm-1.00, 90°  
DIN 71412  
Overall Length: 19mm  
Ball Check, Plated

**11101** Unit Pkg: 5  
**15130** Unit Pkg: 50  
**15131** Unit Pkg: 100

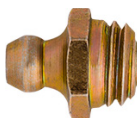

Ref. No: **9501**

10mm-1.5 Straight  
Overall Length: 15mm  
Ball Check, Plated

**17555** Unit Pkg: 50

## Stainless Steel with Ball Check

303 Series Body • 420 Series Ball • 302 Series Spring



**17156**

Ref. No: 8058

8mm-1.00, Straight  
Overall Length: 15mm

UNIT PACKAGE: 5

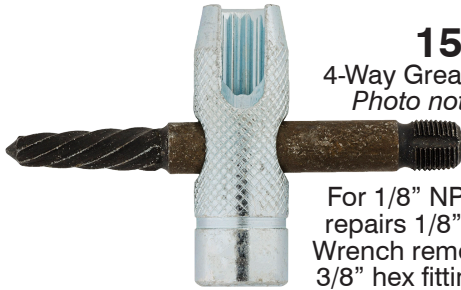

**15694**  
4-Way Grease Fitting Tool  
*Photo not actual size*

For 1/8" NPT fittings. Tap repairs 1/8" NPT threads. Wrench removes 7/16" and 3/8" hex fittings and plugs. Installs new 1/8" NPT fittings. "Easy Out" removes broken fittings.

UNIT PACKAGE: 1



*Photo not actual size*

**16275**

One-Hand Grease Gun  
3-Way Loading  
Uses 14.5 oz. Cartridge  
16 oz. Bulk Capacity  
2500 PSI Working Pressure  
3 Claw Coupler

UNIT PACKAGE: 1

*Photo not actual size*

**16277**  
Zinc with Black Rubber Grip

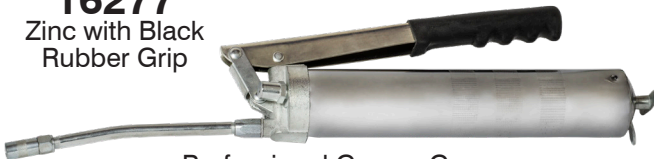

Professional Grease Gun  
Delivers Grease at various Lever Openings  
3-Way Loading  
Uses 14.5 oz. Cartridge, 16 oz. Bulk Capacity  
Variable Pressure  
4 Claw Coupler

UNIT PACKAGE: 1

**16276**

*Photo not actual size*

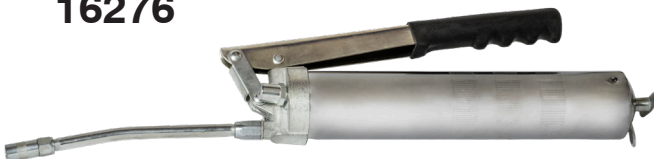

Heavy Duty Grease Gun  
3-Way Loading  
Uses 14.5 oz. Cartridge, 16 oz. Bulk Capacity  
10,000 PSI Working Pressure  
3 Claw Coupler

UNIT PACKAGE: 1



**15688**

Grease Gun Coupler with Ball Check

Fits 1/8" NPT Threads  
Working pressure: 3,000 PSI  
Overall Length: 1-3/8"  
For hand operated lube equipment

UNIT PACKAGE: 1



**15689**

Heavy Duty Grease Gun Coupler with Ball Check

Fits 1/8" NPT Threads  
Working pressure: 5,000 PSI  
Overall Length: 1-7/16"  
For hand operated lube equipment only

UNIT PACKAGE: 1

**Grease Gun Hoses**  
1/8" NPT Male Fittings

*Photo not actual size*

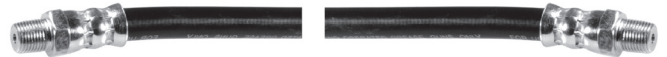

**15691**

12"  
3000 PSI

UNIT PACKAGE: 1

**15692**

18"  
3000 PSI

UNIT PACKAGE: 1

**16279**

12"  
5800 PSI

UNIT PACKAGE: 1

**16280**

18"  
5800 PSI

UNIT PACKAGE: 1

**Grease Fitting Caps**

Polyethylene caps that snap over fittings to seal out dirt and moisture. Integral ring keeps cap in place during servicing.



**18109**  
Black

UNIT PACKAGE: 50



**18110**  
Red

UNIT PACKAGE: 50



**18111**  
Yellow

UNIT PACKAGE: 50



**Hex Head Pipe Plugs**  
Cold Rolled Steel  
Plain Finish

Auveco Part No.	O.E.M. No.	Pipe Size	Unit Pkg.
9278	GM: 444613	1/8-27	25
9279	GM: 444619, GM: 444620	1/4-18	25



**Socket Head Pipe Plugs**  
Cold Rolled Steel  
Plain Finish

Auveco Part No.	O.E.M. No.	Pipe Size	Unit Pkg.
9282	GM: 9427882	1/8-27	25
9283	GM: 444776	1/4-18	25
9284	GM: 444782	3/8-18	25
9285	GM: 444667, GM: 444789	1/2-14	25

**BRASS FITTINGS**

Inverted Flare Fittings



**Inverted Nut**  
Brass

Auveco Part No.	Tube Size	Unit Pkg.
30	3/16"	10
31	1/4"	10
32	5/16"	10
33	3/8"	10



**Inverted Nut**  
Steel

Auveco Part No.	Tube Size	Unit Pkg.
35	1/8"	10
36	3/16"	10
37	1/4"	10
38	5/16"	10
39	3/8"	10



**Steel Plug**

Auveco Part No.	Tube Size	Unit Pkg.
45	3/16"	10
46	1/4"	10
47	5/16"	10



**Male Connector**  
Brass

Auveco Part No.	Tube Size	Pipe Thread	Unit Pkg.
49	1/8"	1/8"	5
50	3/16"	1/8"	5
51	1/4"	1/8"	5
52	5/16"	1/8"	5
53	3/8"	1/4"	5



**Union**  
Brass

Auveco Part No.	Tube Size	Unit Pkg.
69	3/16"	5
70	1/4"	5
72	3/8"	5
73	1/2"	5



**90° Male Elbow**  
Brass

Auveco Part No.	Tube Size	Pipe Thread	Unit Pkg.
75	3/16"	1/8"	5
76	1/4"	1/8"	5
77	5/16"	1/8"	5
78	3/8"	1/4"	5



**45° Male Elbow**  
Brass

Auveco Part No.	Tube Size	Pipe Thread	Unit Pkg.
91	1/4"	1/8"	5



**Male Branch**  
Brass  
*Photo not actual size*

Auveco Part No.	Tube Size	Pipe Thread	Unit Pkg.
96	3/16"	1/8"	5

# BRASS FITTINGS

## Compression Fittings



**Sleeve  
Brass**

Auveco Part No.	Tube Size	Unit Pkg.
101	1/8"	25
102	3/16"	25
103	1/4"	25
105	3/8"	25
107	1/2"	10

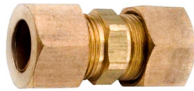

**Union  
Brass**

Auveco Part No.	Tube Size	Unit Pkg.
150	1/8"	5
151	3/16"	5
152	1/4"	5
153	5/16"	5
154	3/8"	5
155	1/2"	5



**Nut  
Brass**

Auveco Part No.	Tube Size	Unit Pkg.
110	1/8"	10
111	3/16"	10
112	1/4"	10
113	5/16"	10
114	3/8"	10



**Male Elbow  
Brass**

Auveco Part No.	Tube Size	Pipe Thread	Unit Pkg.
158	1/8"	1/8"	5
159	3/16"	1/8"	5
161	1/4"	1/4"	5
162	5/16"	1/8"	5
163	5/16"	1/4"	5
164	3/8"	1/8"	5
168	1/2"	1/2"	5



**Male Connector  
Brass**

Auveco Part No.	Tube Size	Pipe Thread	Unit Pkg.
119	1/8"	1/8"	5
120	3/16"	1/8"	5
121	1/4"	1/8"	5
122	1/4"	1/4"	5
123	5/16"	1/8"	5
124	5/16"	1/4"	5
125	3/8"	1/8"	5
126	3/8"	1/4"	5
127	3/8"	3/8"	5
128	1/2"	3/8"	5



**Female Connector  
Brass**

Auveco Part No.	Tube Size	Pipe Thread	Unit Pkg.
134	1/8"	1/8"	5
135	3/16"	1/8"	5
137	5/16"	1/8"	5

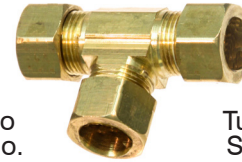

**Union Tee  
Brass**

Auveco Part No.	Tube Size	Unit Pkg.
186	3/16"	5
187	1/4"	5
189	3/8"	5

## Double Compression Fittings

Threaded Sleeve



**Nut  
Brass**

Auveco Part No.	Tube Size	Unit Pkg.
192	1/8"	10
193	3/16"	10
194	1/4"	10



**Male Connector  
Brass**

Auveco Part No.	Tube Size	Pipe Thread	Unit Pkg.
198	1/8"	1/8"	5
200	1/4"	1/8"	5
201	5/16"	1/8"	5

# Sec. 13

## BRASS FITTINGS

### S.A.E. 45° Flared Tube Fittings



**S.A.E. Flare Nut**  
Long • Brass

Auveco Part No.	Tube Size	Unit Pkg.
211	3/16"	5



**S.A.E. Flare Nut**  
Short • Brass

Auveco Part No.	Tube Size	Unit Pkg.
221	1/4"	5
223	3/8"	5
224	1/2"	5

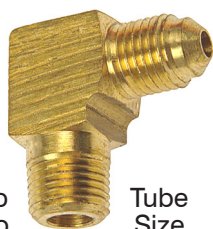

**Male Elbow**  
Brass

Auveco Part No.	Tube Size	Pipe Thread	Unit Pkg.
230	1/4"	1/8"	5
231	1/4"	1/4"	5
232	5/16"	1/8"	5
233	5/16"	1/4"	5



**Union**  
Brass

Auveco Part No.	Tube Size	Unit Pkg.
245	5/16"	5
246	3/8"	5
247	1/2"	5



**Male Connector**  
Brass

Auveco Part No.	Tube Size	Pipe Thread	Unit Pkg.
262	1/4"	1/4"	5
263	5/16"	1/8"	5
264	5/16"	1/4"	5
265	3/8"	1/4"	5
266	3/8"	1/8"	5
268	1/2"	3/8"	5
269	1/2"	1/2"	5

**Refer to page 291 for  
Pipe Thread Identification**

## BRASS FITTINGS

### Pipe Fittings



**Cap**  
Brass

Auveco Part No.	Pipe Thread	Unit Pkg.
287	1/8"	5
288	1/4"	5



**Slotted Plug**  
Brass

Auveco Part No.	Pipe Thread	Unit Pkg.
289	1/8"	5



**Square Head Plug**  
Brass

Auveco Part No.	Pipe Thread	Unit Pkg.
291	1/8"	5
292	1/4"	5
293	3/8"	5
294	1/2"	5



**Hex Head Plug**  
Brass

Auveco Part No.	Pipe Thread	Unit Pkg.
295	1/8"	5
296	1/4"	5
297	3/8"	5
298	1/2"	5



**Bushing**  
Brass

Auveco Part No.	External Pipe Thread	Internal Pipe Thread	Unit Pkg.
299	1/4"	1/8"	5
300	3/8"	1/8"	5
301	3/8"	1/4"	5
302	1/2"	1/8"	5
303	1/2"	1/4"	5
304	1/2"	3/8"	5



# BRASS FITTINGS

Pipe Fittings



**Close Nipple  
Brass**

Auveco Part No.	Length	Pipe Thread	Unit Pkg.
305	3/4"	1/8"	5
306	7/8"	1/4"	5
307	1"	3/8"	5
308	1-1/8"	1/2"	5



**Long Nipple  
Brass**

Auveco Part No.	Length	Pipe Thread	Unit Pkg.
309	1-1/2"	1/8"	5
310	2"	1/8"	5
311	2-1/2"	1/8"	5
313	1-1/2"	1/4"	5
314	2"	1/4"	5
315	2-1/2"	1/4"	5

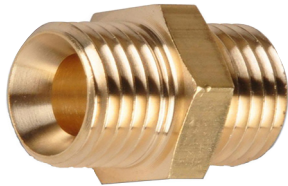

**Hex Nipple  
Brass**

Auveco Part No.	Pipe Thread A	Pipe Thread B	Unit Pkg.
316	1/8"	1/8"	5
317	1/4"	1/4"	5
318	1/4"	1/8"	5
319	3/8"	3/8"	5
320	3/8"	1/8"	5
321	3/8"	1/4"	5
322	1/2"	1/2"	5



**Adapter  
Brass**

Auveco Part No.	Pipe Thread A	Pipe Thread B	Unit Pkg.
325	1/8"	1/8"	5
326	1/4"	1/8"	5
327	1/4"	1/4"	5
328	3/8"	1/4"	5
329	3/8"	3/8"	5
330	1/2"	3/8"	5



**Coupling  
Brass**

Auveco Part No.	Pipe Thread	Unit Pkg.
331	1/8"	5
332	1/4"	5
333	3/8"	5
334	1/2"	5



**Reducing Coupling  
Brass**

Auveco Part No.	Pipe Thread A	Pipe Thread B	Unit Pkg.
335	1/4"	1/8"	5
336	3/8"	1/8"	5
337	3/8"	1/4"	5
339	1/2"	3/8"	5

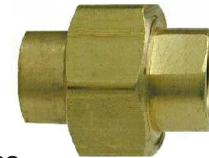

**Union  
Brass**

Auveco Part No.	Pipe Thread	Unit Pkg.
341	1/4"	5



**90° Street Elbow  
Brass**

Auveco Part No.	Internal Pipe Thread	External Pipe Thread	Unit Pkg.
342	1/8"	1/8"	5
343	1/4"	1/4"	5
344	3/8"	3/8"	5



**45° Street Elbow  
Brass**

Auveco Part No.	Pipe Thread	Unit Pkg.
347	1/8"	5
348	1/4"	5
349	3/8"	5

**Sec. 13**

**BRASS FITTINGS**  
Pipe Fittings, Drain Cocks and Valves



**90° Pipe Elbow**  
Brass

Auveco Part No.	Internal Pipe Thread	Unit Pkg.
<b>350</b>	1/8"	5
<b>351</b>	1/4"	5
<b>352</b>	3/8"	5



**Tee**  
Brass

Auveco Part No.	Pipe Thread	Unit Pkg.
<b>355</b>	1/8"	5
<b>356</b>	1/4"	5



**Cross**  
Brass

Auveco Part No.	Pipe Thread	Unit Pkg.
<b>353</b>	1/8"	5

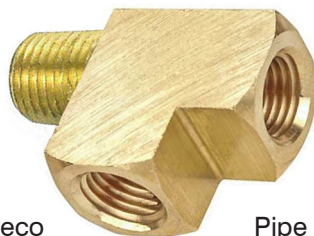

**Street Tee**  
Brass

Auveco Part No.	Pipe Thread	Unit Pkg.
<b>359</b>	1/8"	5
<b>360</b>	1/4"	5

**PIPE THREAD IDENTIFICATION**

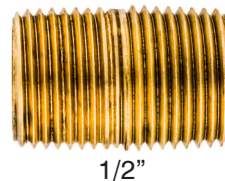
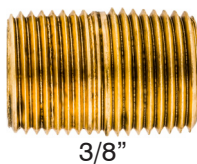
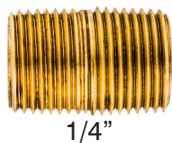

**BRASS FITTINGS**

Drain Cocks and Valves



**External Seat**  
Brass

Auveco Part No.	Pipe Thread	Unit Pkg.
<b>370</b>	1/8"	5
<b>371</b>	1/4"	5
<b>372</b>	3/8"	5

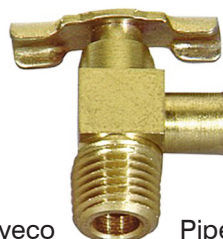

**Angle Bib Drain**  
Brass

Auveco Part No.	Pipe Thread	Height	Unit Pkg.
<b>374</b>	1/4"	1-11/16"	5

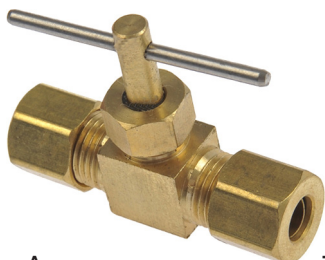

**Compression Line**  
Brass

Auveco Part No.	Tube Size	Unit Pkg.
<b>385</b>	1/4"	3



**Ground Plug Drain**  
Brass

Auveco Part No.	Pipe Thread	Unit Pkg.
<b>405</b>	1/8"	5
<b>406</b>	1/4"	5

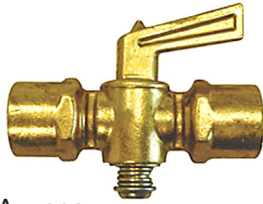

**Female Pipe  
Ground Plug Line  
Brass**

Auveco Part No.	Pipe Thread	Unit Pkg.
<b>399</b>	1/8"	3
<b>401</b>	1/4"	3



**Multiple  
Shut-Off Valves  
Stem Short  
Brass**

Auveco Part No.	Description	Unit Pkg.
<b>404</b>	3 Way, 1/4 Female, 3 Ends	1

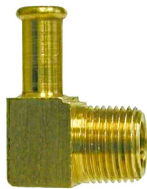

**Beaded Hose Barb  
90° Elbow Tube  
to Male Pipe**

Auveco Part No.	I.D. Hose Size	Pipe Thread	Unit Pkg.
<b>464</b>	5/8"	1/2"	3
<b>465</b>	3/4"	1/2"	2



**Beaded Hose Barb  
Tube to Male Pipe**

Auveco Part No.	I.D. Hose Size	Pipe Thread	Unit Pkg.
<b>413</b>	3/8"	3/8"	5
<b>415</b>	1/2"	3/8"	5
<b>416</b>	5/8"	3/8"	5
<b>417</b>	5/8"	1/2"	5
<b>418</b>	3/4"	1/2"	5

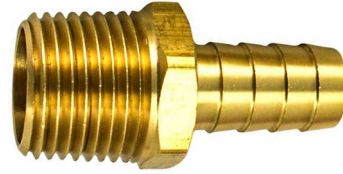

**Hose Barb to  
Taper Male Pipe**

Auveco Part No.	I.D. Hose Size	Pipe Thread	Unit Pkg.
<b>424</b>	3/16"	1/8"	10
<b>425</b>	1/4"	1/8"	10
<b>426</b>	1/4"	1/4"	10
<b>427</b>	1/4"	3/8"	5
<b>428</b>	5/16"	1/8"	10
<b>429</b>	5/16"	1/4"	5
<b>430</b>	3/8"	1/8"	10
<b>431</b>	3/8"	1/4"	10
<b>432</b>	3/8"	3/8"	5
<b>433</b>	1/2"	1/4"	5
<b>434</b>	1/2"	3/8"	5
<b>435</b>	1/2"	1/2"	5



**Barbed Hose  
Coupler**

Auveco Part No.	I.D. Hose Size	Overall Length	Unit Pkg.
<b>419*</b>	3/16"	1.44"	5
<b>420</b>	1/4"	2.00"	5
<b>421</b>	5/16"	2.00"	5
<b>422</b>	3/8"	2.00"	5
<b>423</b>	1/2"	2.00"	5

\* 3 Barb Design



**Hose Barb to  
Taper Female Pipe**

Auveco Part No.	I.D. Hose Size	Pipe Thread	Unit Pkg.
<b>437</b>	1/4"	1/4"	5
<b>438</b>	5/16"	1/4"	5
<b>439</b>	3/8"	1/8"	5
<b>440</b>	3/8"	1/4"	5
<b>442</b>	1/2"	3/8"	5
<b>443</b>	1/2"	1/2"	5



**Hose Barb 90° Elbow  
Tube to Male Pipe**

Auveco Part No.	I.D. Hose Size	Pipe Thread	Unit Pkg.
<b>455</b>	1/4"	1/8"	5
<b>456</b>	1/4"	1/4"	5
<b>457</b>	3/8"	1/4"	5



**Brazier Head  
Solid Aluminum Rivets**

Auveco Part No.	Diameter	Length	Head Diameter	Unit Pkg.
<b>9643</b>	3/16"	3/8"	15/32"	100
<b>9644</b>	3/16"	3/8"	15/32"	1000
<b>12528</b>	3/16"	1/2"	15/32"	100
<b>12529</b>	3/16"	1/2"	15/32"	1000
<b>9647</b>	1/4"	3/8"	5/8"	100
<b>9648</b>	1/4"	3/8"	5/8"	1000

**Refer to pages 316 for  
Drill Bits used with Rivets**



**Pan'1 Blind Rivets**

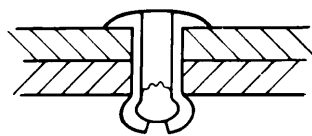

Dome Head

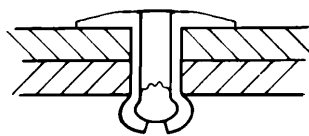

Large Flange

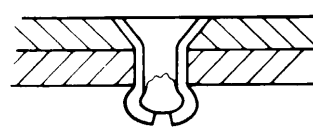

Countersunk

Auveco Part No. Unit Package Quantity					Head (Flange) Type & Diameter	Rivet Diameter	Grip Range	Rivet Length Exc. Flange	Cross Reference	
25	50	100	500	1000					POP®	Marson Klik-Fast

**Steel Rivet & Mandrel •Plated**

	<b>19045</b>				Dome	3/16"	3/32"	1/8" - 1/4"	23/64"	SD34BS	SB3-4
	<b>19046</b>				Dome	1/4"	1/8"	1/32" - 1/16"	13/64"	SD41BS	SB4-1
	<b>5749</b>	<b>5748</b>	<b>8871</b>		Dome	1/4"	1/8"	1/16" - 1/8"	7/32"	SD42BS	SB4-2
	<b>5751</b>	<b>5750</b>	<b>8872</b>		Cntrsnk	7/32"	1/8"	1/16" - 1/8"	7/32"	SK42BS	SC4-2
	<b>8291</b>	<b>8290</b>	<b>8873</b>		Lg Flange	3/8"	1/8"	1/16" - 1/8"	7/32"	SD42BSLF	SBL4-2
	<b>8874</b>	<b>8875</b>			Dome	1/4"	1/8"	1/8" - 3/16"	5/16"	SD43BS	SB4-3
	<b>5753</b>	<b>5752</b>	<b>8877</b>		Dome	1/4"	1/8"	3/16" - 1/4"	25/64"	SD44BS	SB4-4
	<b>8303</b>	<b>8302</b>			Cntrsnk	7/32"	1/8"	3/16" - 1/4"	25/64"	SK44BS	SC4-4
	<b>8293</b>	<b>8292</b>	<b>8879</b>		Lg Flange	3/8"	1/8"	3/16" - 1/4"	25/64"	SD44BSLF	SBL4-4
	<b>8880</b>	<b>8881</b>	<b>8882</b>		Dome	1/4"	1/8"	5/16" - 3/8"	1/2"	SD46BS	SB4-6
	<b>19047</b>				Dome	1/4"	1/8"	3/8" - 1/2"	41/64"	SD48BS	SB4-8
	<b>8883</b>	<b>8884</b>			Dome	5/16"	5/32"	1/16" - 1/8"	7/32"	SD52BS	SB5-2
	<b>8886</b>	<b>8887</b>	<b>8888</b>		Dome	5/16"	5/32"	3/16" - 1/4"	3/8"	SD54BS	SB5-4
	<b>8889</b>				Dome	3/8"	3/16"	1/16" - 1/8"	9/32"	SD62BS	SB6-2
	<b>8892</b>	<b>8893</b>	<b>8894</b>		Dome	3/8"	3/16"	1/8" - 1/4"	7/16"	SD64BS	SB6-4
<b>18811</b>					Lg Flange	5/8"	3/16"	1/8" - 1/4"	7/16"	SD64BSLF	SBL6-4
	<b>8895</b>	<b>8896</b>	<b>8897</b>		Dome	3/8"	3/16"	1/4" - 3/8"	9/16"	SD66BS	SB6-6
	<b>8305</b>	<b>8304</b>	<b>8898</b>		Lg Flange	5/8"	3/16"	1/4" - 3/8"	9/16"	SD66BSLF	SBL6-6
	<b>8899</b>	<b>8900</b>	<b>8901</b>		Dome	3/8"	3/16"	3/8" - 1/2"	11/16"	SD68BS	SB6-8
<b>18812</b>					Lg Flange	5/8"	3/16"	3/8" - 1/2"	11/16"	SD68BSLF	SBL6-8
	<b>8902</b>	<b>8903</b>			Dome	3/8"	3/16"	1/2" - 5/8"	13/16"	SD610BS	SB6-10
<b>18814</b>					Lg Flange	5/8"	3/16"	5/8" - 3/4"	15/16"	SD612BSLF	SBL6-12
<b>21402</b>					Dome	1/2"	1/4"	5/8" - 3/4"	1"	SD812BS	
<b>19048</b>					Dome	1/2"	1/4"	3/4" - 1"	1-15/64"	SD816BS	

(Continued on next page)

# PAN'L BLIND RIVETS

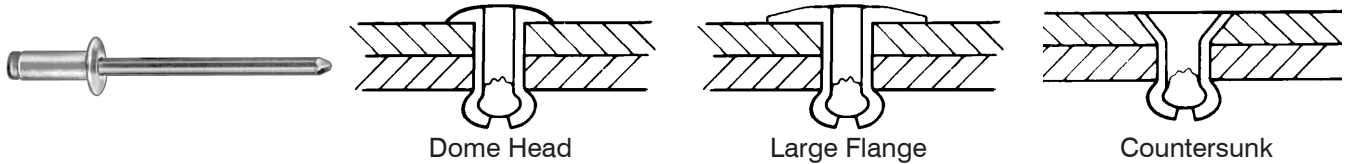

Auveco Part No.				Head (Flange) Type & Diameter	Rivet Diameter	Grip Range	Rivet Length Exc. Flange	Cross Reference	
Unit	Package	Quantity	POP®					Marson Klik-Fast	

### Aluminum Rivet • Steel Mandrel

8905	8906		Dome	1/4"	1/8"	1/16" - 1/8"	7/32"	AD42BS	AB4-2
8908	8909		Cntrs nk	7/32"	1/8"	1/16" - 1/8"	7/32"	AK42BS	AC4-2
8911	8912	8913	Dome	1/4"	1/8"	3/16" - 1/4"	3/8"	AD44BS	AB4-4
8914	8915		Cntrs nk	7/32"	1/8"	3/16" - 1/4"	3/8"	AK44BS	AC4-4
19049			Dome	1/4"	1/8"	3/8" - 1/2"	41/64"	AD48BS	AB4-8
19050			Dome	5/16"	5/32"	3/16" - 1/4"	27/64"	AD54BS	AB5-4
8295	8294	8917	Dome	3/8"	3/16"	1/16" - 1/8"	9/32"	AD62BS	AB6-2
8307	8306	8918	Dome	3/8"	3/16"	1/8" - 1/4"	3/8"	AD64BS	AB6-4
8297	8296	8919	Dome	3/8"	3/16"	1/4" - 3/8"	9/16"	AD66BS	AB6-6
19051			Lg Flange	5/8"	3/16"	3/8" - 1/2"	11/16"	AD68BSLF	ABL6-8

### Aluminum Rivet & Mandrel

19053			Dome	3/16"	3/32"	1/32" - 1/8"	15/64"	AD32ABS	AB3-2A
8309	8308	8920	Dome	1/4"	1/8"	1/16" - 1/8"	7/32"	AD42ABS	AB4-2A
8299	8298		Cntrs nk	7/32"	1/8"	1/16" - 1/8"	7/32"	AK42ABS	AC4-2A
8922	8923	8924	Lg Flange	3/8"	1/8"	1/16" - 1/8"	7/32"	AD42ABSLF	ABL4-2A
8925	8926	8927	Dome	1/4"	1/8"	3/16" - 1/4"	3/8"	AD44ABS	AB4-4A
8928	8929	8930	Cntrs nk	7/32"	1/8"	3/16" - 1/4"	3/8"	AK44ABS	AC4-4A
8931	8932	8933	Lg Flange	3/8"	1/8"	3/16" - 1/4"	3/8"	AD44ABSLF	ABL4-4A
16031			Dome	1/4"	1/8"	5/16" - 3/8"	1/2"	AD46ABS	AB4-6A
16032			Dome	1/4"	1/8"	3/8" - 1/2"	5/8"	AD48ABS	AB4-8A
20474			Lg. Flange	3/8"	1/8"	3/8" - 1/2"	5/8"		ABL4-8A
18727			Dome	5/16"	5/32"	1/16" - 1/8"	9/32"	AD52ABS	AB5-2A
18728			Dome	5/16"	5/32"	1/8" - 3/16"	11/32"	AD53ABS	AB5-3A
18729			Dome	5/16"	5/32"	3/16" - 1/4"	13/32"	AD54ABS	AB5-4A
18732			Lg Flange	15/32"	5/32"	3/16" - 1/4"	13/32"	AD54ABSLF	
18730			Dome	5/16"	5/32"	1/4" - 3/8"	1/2"	AD56ABS	AB5-6A
18731			Dome	5/16"	5/32"	3/8" - 1/2"	5/8"	AD58ABS	AB5-8A
5755	5754	8934	Dome	3/8"	3/16"	1/16" - 1/8"	9/32"	AD62ABS	AB6-2A
8311	8310	8935	Dome	3/8"	3/16"	1/8" - 1/4"	7/16"	AD64ABS	AB6-4A
19055			Lg Flange	5/8"	3/16"	1/8" - 1/4"	7/16"	AD64ABSLF	ABL6-4A
8301	8300	8936	Dome	3/8"	3/16"	1/4" - 3/8"	9/16"	AD66ABS	AB6-6A
8313	8312	8937	Lg Flange	5/8"	3/16"	1/4" - 3/8"	9/16"	AD66ABSLF	ABL6-6A
8938	8939	8940	Dome	3/8"	3/16"	3/8" - 1/2"	11/16"	AD68ABS	AB6-8A
19056			Lg Flange	5/8"	3/16"	3/8" - 1/2"	11/16"	AD68ABSLF	ABL6-8A
18489			Dome	3/8"	3/16"	1/2" - 5/8"	13/16"	AD610ABS	AB6-10A
19057			Lg Flange	5/8"	3/16"	1/2" - 5/8"	13/16"	AD610ABSLF	ABL6-10A
19058			Dome	1/2"	1/4"	1/4" - 3/8"	39/64"	AD86ABS	AB8-6A

### Stainless Steel Rivet & Mandrel

19060			Dome	1/4"	1/8"	3/16" - 1/4"	25/64"	SSD44SSBS	SSB4-4S
19061			Dome	3/8"	3/16"	3/8" - 1/2"	11/16"	SSD68SSBS	SSB6-8S

### Stainless Steel Rivet • Steel Mandrel

Replaces Ford No.: 383229-S

To replace welded studs on body. (Use Auveco Rivet Gun 7915 with 7981 Nose Piece.)

11104	11105	11106	Sm. Flange	3/16"	1/8"	3/16" - 1/4"	5/16"	R4357	SSBN4-3
-------	-------	-------	------------	-------	------	--------------	-------	-------	---------



**Steel Rivet Washers**  
Zinc

**16791**

Outer Diameter: 1/2"  
For 1/8" Diameter

UNIT PACKAGE: 100

**15973**

Outer Diameter: 1/2"  
For 5/32" Diameter

UNIT PACKAGE: 100

**16792**

Outer Diameter: 15/32"  
For 3/16" Diameter

UNIT PACKAGE: 100

**22409**

Economy Rivet Gun

*Photo not actual size*



Overall Length: 10"  
With 3/32", 1/8", 5/32" and 3/16" nose pieces.  
Replacement accessories are not available

UNIT PACKAGE: 1

**7915**

Pan'l Rivet Gun

*Photo not actual size*



Overall Length: 9-1/2"  
With 3/32", 1/8", 5/32" and 3/16" nose pieces

UNIT PACKAGE: 1



**19215**

Replacement Jaws for  
Auveco Rivet Gun 7915

UNIT PACKAGE: 1 Set



**Nose Pieces**

For Auveco Rivet Gun 7915

Auveco Part No.	Description	Unit Pkg.
<b>7981</b>	Use with 1/8" rivet 11104 to replace welded studs	1
<b>7983</b>	For 1/8" diameter rivets	1
<b>7984</b>	For 5/32" diameter rivets	1
<b>7985</b>	For 3/16" diameter rivets	1

**11817**



*Photo not actual size*

Rivet gun for setting 3/16" & 1/4" rivets.  
Use to install "Peel-Type" Rivets.  
Comes complete with 3/16" and 1/4" standard nose pieces plus a nose piece for 1/4" "Peel Type" rivets.  
Length: 22"

UNIT PACKAGE: 1



**19132**

Nose piece for 1/8" standard rivets  
Auveco 11817 Accessory

UNIT PACKAGE: 1



**19133**

Nose piece for 3/16" standard rivets  
Auveco 11817 Accessory

UNIT PACKAGE: 1



**19134**

Nose piece for 1/4" standard rivets  
Auveco 11817 Accessory

UNIT PACKAGE: 1



**11853**

Nose piece for 1/4" "Peel Type" rivets.  
Auveco 11817 Accessory

UNIT PACKAGE: 1



**14799**

Replacement jaws repair kit for  
Auveco Rivet Gun 11817

UNIT PACKAGE: 1



**21655**

Nose Piece  
For 3/16" Monobolts  
Auveco 11817 Accessory

UNIT PACKAGE: 1



**21656**

Nose Piece  
For 1/4" Monobolts  
Auveco 11817 Accessory

UNIT PACKAGE: 1



**13808**

For 3/16" Rivets  
Nose piece for setting  
Auveco Klamp-Tite Rivets with  
a Pneumatic Tool.

UNIT PACKAGE: 1



**19066**  
Rivet Gun

*Photo not actual size*

Overall Length: 21"  
With nose pieces for 3/32", 1/8", 5/32",  
3/16" & 1/4" diameter rivets.

UNIT PACKAGE: 1



**13756**

Rivet Setter Gun  
For Nylon Rivets

For use with nylon  
(plastic) blind rivets.

A durable tool that sets all  
sizes with a single stroke.  
All steel construction.  
Not for use with metal rivets.  
Length: 6-1/2"

UNIT PACKAGE: 1

## TIPS FOR NAVIGATING THE CATALOG

- **Color Coded Pages**

**Yellow-** New Items

**Blue-** Metric Items

**Brown-** Electric Accessories

**Green-** Assortments, Cabinets,  
Bins and Racks

**Gray-** Key Blanks & Accessories

**Pink-** Import Car Body Hardware

- **Specification Charts**

**Body Bolts-** Pages: 88 & 121-122

**Special Tapping Screws-** Pages: 91-94 & 128-130

**License Plate Screws-** Pages: 105-106

**Retainers-** Pages: 475-489

**Push-Type Retainers-** Pages: 534-545

- **Indexes. Located in the front**

**Pictorial**

**Alphabetical**

**Numerical**

- Images are actual size unless noted otherwise

- OEM Part Cross Reference: Indexed according to OEM number and Part Number. Located in the back

*Located in the front after the numerical index*

- Screw Identification charts: head styles, driving recesses, point styles and sizing.

- List of common terminology with brief descriptions

- Plating and finish types with brief descriptions

# Sec. 14

# AUTOMOTIVE O.E.M. NYLON BLIND RIVETS

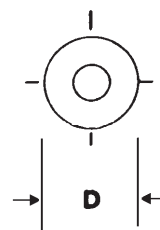
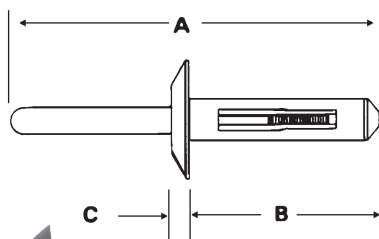
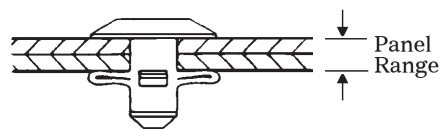

Type 1

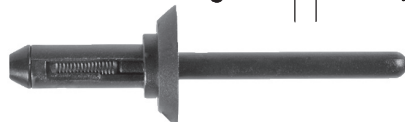

Type 2



Type 3



Type 4



Type 5



Type 6

Auveco Part No.	Type	Color	O.E.M. Number	Hole Diameter	Panel Range (Grip)	A	B	C	D	Unit Pkg.
17220	3	Black	GM: 21094747	5/32"	7/64"-7/32"	1-7/8"	3/4"	3/32"	**	50
15187	6	Black	Ford: N804583S	4mm	6mm-10.5mm	65mm	26mm	2.5mm	***	25
13746	1	Black	GM: 20612732	3/16"	1/16"-9/64"	1-7/8"	23/32"	3/32"	11/32"	25
18501	1	Black	Chry: 6502689	3/16"	5/32"-1/4"	1-27/32"	21/32"	1/16"	11/32"	25
21327	1	Black	GM: 11588308	4.95mm	3mm - 6mm	48mm	18mm	1.7mm	9mm	25
13747	1	Black	GM: 20423647, Ford: N804189S	13/64"	1/16"-11/64"	1-7/8"	23/32"	1/8"	15/32"	25
14005	1	Black	GM: 20465395, Chry: 6004212	13/64"	1/8"-5/32"	1-13/16"	21/32"	1/16"	11/32"	25
13748	1	Black	GM: 20432975, VW:175-853-57701C, Chry: 6503800, Ford: N804343S	13/64"	1/8"-15/64"	1-7/8"	25/32"	1/16"	15/32"	25
13754	1	Black	Chry: 6500859	13/64"	1/8"-3/16"	1-7/8"	25/32"	1/16"	15/32"	25
13755	1	Black	Chry: 6500898 GM: 15718794	13/64"	15/64"-25/64"	2"	1"	1/16"	15/32"	25
14004	1	Black	GM: 25524005	15/64"	11/64"-11/32"	2-3/64"	1-1/8"	3/32"	1/2"	25
14023	1	Black	GM: 10036503	15/64"	5/32"-5/16"	2-1/8"	1-5/32"	3/32"	5/8"	25
18913	1	Black	Chry: 6503938	15/64"	5/32"-9/32"	2-5/32"	1-1/16"	3/32"	1/2"	25
20754	1	Black	BMW: 51-71-7-002-953-2	6mm	2.5mm-4.8mm	53mm	22mm	2.5mm	20mm	25
18028	2	Black	Chry: 4630088	1/4"	1/32"-11/64"	2-3/16"	13/16"	3/32"	21/32"	25
18031	2	Black*	Chry: 4630660	1/4"	1/32"-3/16"	2-1/8"	3/4"	3/32"	21/32"	25
15488	4	Black	GM: 10069112	1/4"	3/64"-5/32"	2-3/16"	15/16"	7/64"	13/16"	50
18242	5	Black	Chry: 6501509	1/4"	3/64"-3/16"	2-7/32"	1-1/8"	3/32"	25/32"	25
13749	1	White	GM: 14070914	1/4"	5/32"-15/64"	2-3/16"	23/32"	3/32"	21/32"	25
21446	1	Black	Chry: 6508444-AA	1/4"	5/32"-15/64"	2-3/16"	1-1/8"	3/32"	1-1/32"	15
18502	1	Black	General Purpose	1/4"	5/32"-1/4"	2-3/16"	23/32"	3/32"	21/32"	25
21028	1	Black	GM: 15614746	1/4"	5/32"-3/8"	2-3/16"	1-1/8"	3/32"	21/32"	25
18108	1	Black	Chry: 34201631	1/4"	5/32"-3/8"	2-7/32"	1-1/8"	3/32"	11/16"	25
17496	1	Gray	AMC: 8934-201-835	1/4"	5/32"-3/8"	2-7/32"	1-1/8"	3/32"	11/16"	25
14012	1	White	GM: 15506827	1/4"	5/32"-13/32"	2"	1-1/8"	3/32"	21/32"	25

\* Black Rivet Body, White Mandrel

\*\* 5/16" x 19/32"

\*\*\* 8.5mm x 15.5mm

(Continued on next page)



# AUTOMOTIVE O.E.M. NYLON BLIND RIVETS

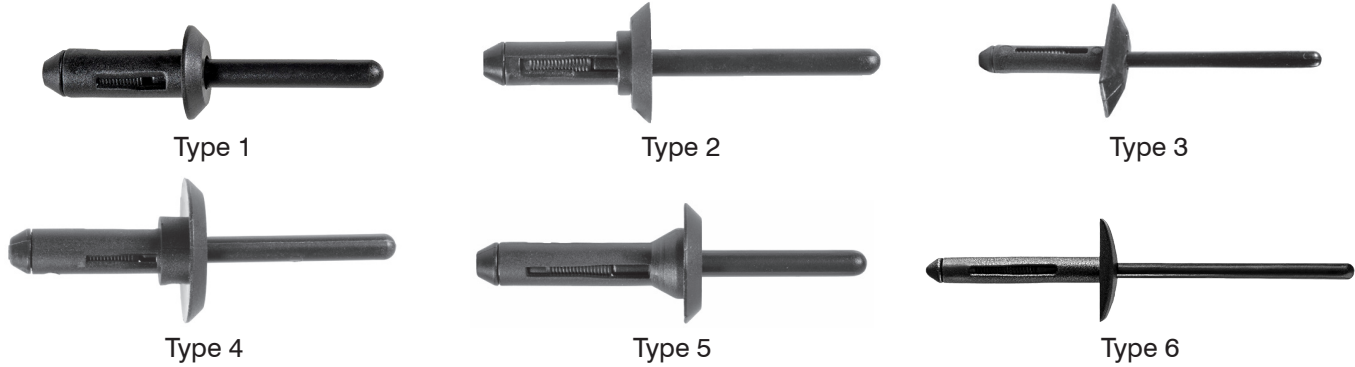

Auveco Part No.	Type	Color	O.E.M. Number	Hole Diameter	Panel Range (Grip)	A	B	C	D	Unit Pkg.
<b>13751</b>	1	Black	GM: 10184895 Ford: N803862-S Chry: 6501559,6506007-AA	1/4"	5/32"-13/32"	2-3/16"	1-3/32"	3/32"	1/2"	25
<b>13750</b>	1	Black	GM: 14063981 Ford: N803043-S Chry: 6500911, 6504700	1/4"	5/32"-13/32"	2-3/16"	1-3/32"	3/32"	21/32"	25
<b>15491</b>	1	Black	Ford: N804759-S	1/4"	19/64"-27/64"	2-1/8"	13/16"	3/32"	21/32"	25
<b>17101</b>	1	Black	Ford: N804675S Chry: 4370138, 6503860	1/4"	5/16"-15/32"	2-9/32"	1-1/4"	3/32"	21/32"	25
<b>22139</b>	4	Black	Ford: N803739-S	6.3mm	.70-.85mm	56mm	20mm	3mm	18mm	25
<b>13752</b>	1	Black	GM: 15955172, 20421672	17/64"	3/32"-3/16"	1-7/8"	25/32"	3/32"	1/2"	25
<b>13753</b>	1	Black	GM: 20433026 VW: 175-853-577A	17/64"	3/32"-3/16"	1-7/8"	25/32"	3/32"	23/32"	25
<b>15490</b>	1	Black	GM: 10109689, 12337915	9/32"	3/32"-15/64"	2-3/16"	15/16"	3/32"	23/32"	25

Note: Use rivet guns 13756 to install all of the above rivets.

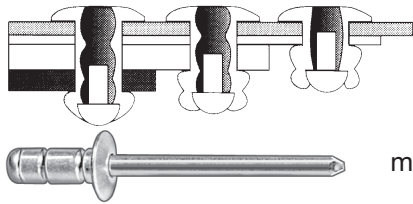

## POP® MULTI-GRIP BLIND RIVETS

Functions in a Wide Range of Material Thickness

The Multi-Grip rivet will serve in applications where solid, soft materials and thicknesses normally require several rivet sizes. Oversize, irregular or misaligned holes are automatically compensated for by self-adjusting hole-filling capability. The mandrel head is retained in the rivet body, forming a tight, weather resistant seal.

Auveco Part No.	Head Style & Diameter	Rivet Diameter	Hole Size	Grip Range	Rivet Length Excluding Flange	Unit Pkg.	Pop® No.
<b>Aluminum Rivet • Steel Mandrel</b>							
<b>19033</b>	Large Flange 3/8"	1/8"	.129"-.142"	3/64"-3/16"	21/64"	100	AD41-43BSLF
<b>19025</b>	Dome 1/4"	1/8"	.129"-.142"	5/32"-5/16"	15/32"	100	AD43-45BS
<b>19034</b>	Large Flange 3/8"	1/8"	.129"-.142"	5/32"-5/16"	15/32"	100	AD43-45BSLF
<b>19026</b>	Dome 1/4"	1/8"	.129"-.142"	1/4"-7/16"	39/64"	100	AD45-47BS
<b>18743</b>	Dome 5/16"	5/32"	.160"-.173"	3/64"-1/4"	13/32"	100	AD52-54BS
<b>17468</b>	Large Flange 15/32"	5/32"	.160"-.173"	3/64"-1/4"	13/32"	50	AD52-54BSLF
<b>19027</b>	Dome 5/16"	5/32"	.160"-.173"	1/8"-5/16"	1/2"	50	AD53-55BS
<b>18744</b>	Dome 3/8"	3/16"	.192"-.205"	1/16"-1/4"	7/16"	50	AD62-64BS
<b>19036</b>	Large Flange 5/8"	3/16"	.192"-.205"	1/16"-1/4"	7/16"	50	AD62-64BSLF
<b>19028</b>	Dome 3/8"	3/16"	.192"-.205"	3/16"-3/8"	5/8"	50	AD63-66BS
<b>19029</b>	Dome 3/8"	3/16"	.192"-.205"	1/4"-1/2"	47/64"	50	AD66-68BS
<b>19037</b>	Large Flange 5/8"	3/16"	.192"-.205"	1/4"-1/2"	47/64"	50	AD66-68BSLF
<b>19030</b>	Dome 3/8"	3/16"	.192"-.205"	7/16"-3/4"	1-1/16"	50	AD68-612BS
<b>19031</b>	Dome 1/2"	1/4"	.261"-.275"	5/64"-11/32"	39/64"	25	AD82-86BS

**What makes Avex different and better?**

The Avex rivet adds important and exclusive features to those offered by ordinary blind rivets. The unique advantages designed into the Avex rivet allow for its use:

**In wide-tolerance holes.** Since the rivet can expand up to its own head diameter, accurate hole sizing or alignment is not necessary.

**To pull sheets together.** The extraordinary rivet tail expansion automatically effects superior clamp-up action on the parts being assembled.

**Over a vast range of thicknesses.** The “dubble-bubble” expansion feature offers the capability to fasten securely in both thick and thin grip ranges with a single length rivet.

**While providing a sealed stem.** The rivet material flows both behind and in front of the mandrel insuring a positively retained and sealed stem.

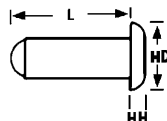

Dome Head

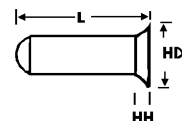

120° Countersunk

Auveco Part No.			Head (Flange) Style	Rivet Diameter	Grip	Length L	Flange Diameter HD	Flange Height HH	Hole Size
Unit	Package	Quantity							
25	100	500 1000							
	<b>10336</b>	<b>10337</b>	Countersunk	1/8"	To 1/4"	15/32"	.205"	.030"	.136"
	<b>10351</b>	<b>10352</b>	Dome	5/32"	To 1/4"	15/32"	.255"	.057"	.166"
	<b>10357</b>	<b>10358 10359</b>	Dome	3/16"	To 7/16"	23/32"	.349"	.070"	.199"
	<b>10345</b>	<b>10346</b>	Countersunk	3/16"	To 1/2"	25/32"	.339"	.050"	.199"
<b>17654</b>	<b>17655</b>		Dome	1/4"	To 11/32"	21/32"	.500"	.094"	.268"

**Avex® Brazier Head Rivet**



**17433**  
Yellow Zinc

Diameter: 3/16"  
Grip: 3/16"-7/16"  
Head Diameter: 15/32"  
Body Length: 11/16"  
Aluminum Rivet & Steel Mandrel

UNIT PACKAGE: 50

**Large Head 3/16" Plywood Rivets**

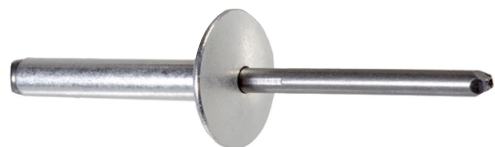

Non-Structural  
Break Mandrel Rivets  
Aluminum Rivet & Steel Mandrel (Plated)

Auveco Part No.	Grip	Head Diameter	Head Thickness	Hole Size & Drill	Unit Pkg.
<b>13805</b>	3/8"-1/2"	5/8"	3/32"	.192 to .196"	50
<b>13807</b>	7/8"-1"	5/8"	3/32"	#11	50

**Stavex® Large Flange Rivets**

- Large flange head enables soft, pliable materials to be fastened
- All steel construction (zinc plated) provides high shear and tensile values.
- Typical applications:
  - Plastic energy absorbing strip to automotive bumper
  - Plywood liners to both sidewalls and roofs in truck bodies and trailers



Auveco Part No.	Diameter	Grip	Flange Diameter	Hole Size	Unit Pkg.
<b>16988</b>	3/16"	3/64"-1/4"	5/8"	.192-.196"	25
<b>16989</b>	3/16"	1/16"-3/8"	5/8"	.192-.196"	25

## Auveco Klamp-Tite Rivets

- Largest Blind Head
  - Fills hole tightly
  - High Clamp-Up
- Water Tight Capability
  - Fully Cored
- Structural- Self Plugging
- Head Style- Protruding

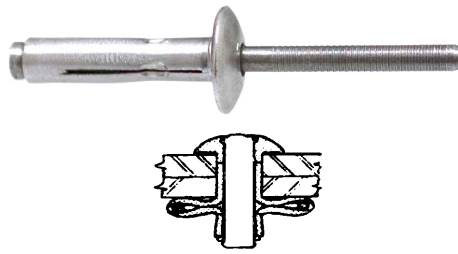

Mandrel breaks flush with top of rivet head anywhere within grip range.

Material: Rivet 5056 Aluminum,  
Mandrel 7075 Aluminum  
Finish: Wax (Do Not Remove)

Note: For use with pneumatic tool using 13808 (3/16") nose piece on page 296.

Auveco Part No.	Unit Pkg.	Rivet Diameter	Grip Range	Hole & Drill Size	Mandrel Diameter	Head Diameter	Head Thickness	Rivet Length Max
<b>13766</b>	50	3/16	3/64" - 1/4"	.204-.209 (#5)	.103	.445	.088	.890
<b>13767</b>			3/16" - 3/8"					.985
<b>13768</b>			3/8" - 9/16"					1.045
<b>13769</b>	25	1/4	3/64" - 1/4"	.252-.262 (F)	.136	.560	.113	.920
<b>13770</b>			3/16" - 3/8"					1.045

## Blind Tacking Rivets

- Steel Rivet: Plated
- Non-Structural: Break mandrel rivets
  - Steel Mandrel: Coated
- Conform to IFI-114 Standards

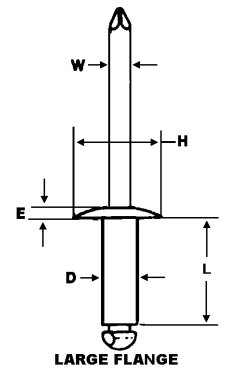
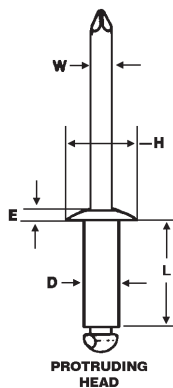
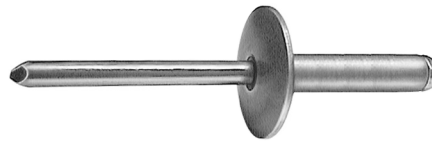

Nom. Rivet Diameter	Hole Size & Drill Number	W Mandrel Diameter	D Rivet Diameter	Protruding Head		Large Flange Head	
				H Head Diameter	E Max.	H Head Diameter	E Max.
1/4"	.257-.261 (F)	.151	.250	.500	.080	.750	.107

Auveco Part No.	Head Style	Rivet Diameter	Grip	Rivet Length L	Unit Pkg.
<b>13796</b>	Large Flange	1/4"	1/2" - 5/8"	13/16"	25

## Large Secondary Head Rivets



Rivets that fasten securely into thick and thin materials. Will pull soft or brittle materials. Can be used in an oversized hole.

Auveco Part No.	Head (Flange) Type & Diameter	Rivet Diameter	Grip Range	Rivet Length Excluding Flange	Unit Pkg.
Aluminum Rivet & Mandrel					
<b>17471*</b>	Dome 5/16"	1/8"	5/64"-3/8"	31/32"	25
<b>19062</b>	Dome 5/16"	5/32"	0-1/4"	23/32"	25

\* Not a Split Type

Monobolt® Fastening System

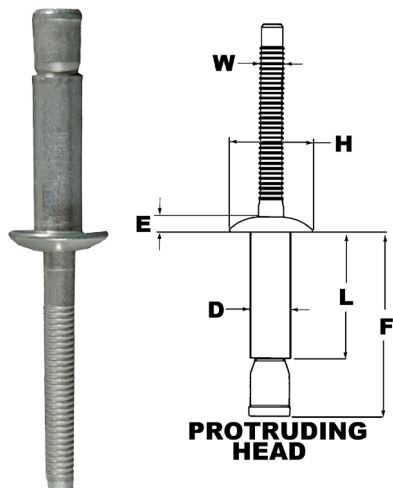

Nom. Rivet Diameter	Hole Size & Drill Number	W Mandrel Diameter	D Rivet Diameter	Protruding Head	
				H Head Diameter	E Head Max.
3/16	.191-.201 (#11)	.118	.187	.390	.070
1/4	.261-.272(G)	.157	.257	.515	.100

Typical Rivet Shear and Tensile Strength (lbs) and Mandrel push-out when installed in Nominal Grip.

Rivet Diameter	Aluminum Rivet & Mandrel			Steel Rivet & Mandrel		
	Shear	Tensile	Mandrel Push-out	Shear	Tensile	Mandrel Push-out
3/16	625	500	50	1300	1000	100
1/4	1300	890	100	2400	2150	250

Auveco Part No.	Diameter	Grip	DIM "L"	DIM "F"	Head Style	Material	Unit Pkg.
12080	3/16"	.062/.270	.406	.748	Protruding	Steel-Zinc Plated	25
12088	3/16"	.062/.270	.406	.748	Protruding	Steel-Zinc Plated	100
12081	3/16"	.214/.420	.531	.882	Protruding	Steel-Zinc Plated	25
12089	3/16"	.214/.420	.531	.882	Protruding	Steel-Zinc Plated	100
12084	1/4"	.080/.375	.550	.971	Protruding	Steel-Zinc Plated	25
12092	1/4"	.080/.375	.550	.971	Protruding	Steel-Zinc Plated	100
12085	1/4"	.350/.625	.855	1.123	Protruding	Steel-Zinc Plated	25
12093	1/4"	.350/.625	.855	1.123	Protruding	Steel-Zinc Plated	100
12086	1/4"	.080/.375	.550	.961	Protruding	Aluminum	25
12094	1/4"	.080/.375	.550	.961	Protruding	Aluminum	100
13773	1/4"	.350/.625	.810	1.174	Protruding	Aluminum	25
13774	1/4"	.350/.625	.810	1.174	Protruding	Aluminum	100

The System

**Blind Installation:** The single side installation feature of the Auveco Monobolt System allows one operator to produce high quality structural joints in seconds. Use of the Monobolt power tool does not require special skill or training, because the tool completely controls the installation cycle.

**Multi-Grip:** One size Monobolt fastener will function effectively in a wide range of material thicknesses (Example: .080" to .375"). This versatility decreases the potential for production errors and reduces fastener inventory requirements.

**Uniform Clamping Action:** Monobolt fasteners are engineered to draw materials together by developing positive clamping action.



Its Advantages

**Structural Fastening:** An installed Monobolt fastener yields high shear and tensile values. Conventional fasteners can be replaced by Monobolt without compromising structural requirements.

**Positive Stem Retention:** At the completion of the installation cycle, the stem is mechanically locked into the Monobolt shell, creating a vibration-proof joint of assured structural quality.

**Flush Break Stem:** Within the specific grip range for each size, Monobolt fastener, the stem is designed to break flush with the low profile head. Secondary finishing operations, such as grinding or milling, are not necessary to achieve good product appearance.

**Complete Hole Fill:** During installation, the Monobolt shell expands into 360° contact with the walls of the parent material. This feature, in conjunction with positive stem retention, produces weather resistant joints.

**Quiet, Safe Installation:** The Monobolt System, operating at 85db ("A" Weighted), complies with OSHA regulation governing plant noise levels and operator safety

How it Works



1. The Monobolt fastener is loaded into the nose of the placing tool and inserted in a prepared hole. As the tool is actuated, the pulling jaws grip the Monobolt stem.



2. An axial pull draws the stem through the shell, expanding it radially. During this phase, the hole is completely filled and work pieces are drawn together.



3. When the stem reaches a pre-determined position within the Monobolt shell, it separates flush with the head profile regardless of work piece thickness. Simultaneously, the stem section remaining in the shell is mechanically locked in place by the Monobolt tool.

## Interlock® Dome Head High Strength Rivets



High strength Interlock® rivets feature a positive mechanical locking system that provides superior holding power. This system also guarantees 100% mandrel retention that's visually verifiable. Can be set with Auveco Rivet Gun 11817.

Auveco Part No.	Rivet Diameter	Grip Range	Rivet Body Length	Head Diameter	Unit Pkg.	Conversion			
						Interlock®	Cherry Monobolt	Avdel Monobolt	Huck Magna-lock
<b>Aluminum Rivet &amp; Mandrel</b>									
17421	3/16"	1/16" - 17/64"	13/32"	3/8"	25	AD6270UG	BAPV-64	2774-0613	MGLP-B6-4
17422	3/16"	1/16" - 7/16"	9/16"	3/8"	25	AD6437UGX		2774-0617	MGLP-B6-E
17423	1/4"	5/64" - 3/8"	9/16"	1/2"	25	AD8375UG	BAPV-86	2774-0817	MGLP-B8-6
17424	1/4"	5/64" - 5/8"	13/16"	1/2"	15	AD8625UGX		2774-0824	MGLP-B8-E
<b>Steel Rivet &amp; Mandrel</b>									
17425	3/16"	1/16" - 17/64"	13/32"	3/8"	25	SD6270UG	SSPV-64	2771-0613	MGLP-R6-4
17427	1/4"	5/64" - 3/8"	9/16"	1/2"	25	SD8375UG	SSPV-86	2771-0817	MGLP-R8-6
17428	1/4"	5/64" - 5/8"	13/16"	1/2"	15	SD8625UGX		2771-0824	MGLP-R8-E
<b>Stainless Steel Rivet &amp; Mandrel</b>									
17429	3/16"	1/16" - 17/64"	13/32"	3/8"	10	SSD6270UG	CCPV64	2711-0613	MGLP-U6-4



## Closed - End Rivets

Can be set with Auveco Rivet Gun 7915

Auveco Part No.	Head (Flange) Type	Head Diameter	Rivet Diameter	Grip Range	Rivet Length Excluding Flange	Unit Pkg.
<b>Black Aluminum Rivet &amp; Mandrel</b>						
17408	Dome	15/64"	1/8"	13/64" - 9/32"	15/32"	50
17410	Dome	3/8"	3/16"	3/8" - 1/2"	11/16"	25
<b>Aluminum Rivet &amp; Mandrel</b>						
17419	Dome	3/8"	3/16"	1/16" - 1/8"	11/32"	50
17420	Dome	3/8"	3/16"	1/8" - 1/4"	15/32"	50
<b>Aluminum Rivet &amp; Steel Mandrel</b>						
17411	Dome	15/64"	1/8"	1/16" - 1/8"	5/16"	50
19065	Countersunk	5/16"	5/32"	1/8" - 3/16"	13/32"	100
17415	Dome	3/8"	3/16"	1/8" - 1/4"	15/32"	50
17416	Dome	3/8"	3/16"	1/4" - 3/8"	19/32"	50

## "PEEL - TYPE" SPECIALTY RIVETS

Use 11817 Rivet Gun with 11853 Nose Piece (Page 295) to set all 1/4" "Peel-Type" Rivets



**19414**  
(W525170-S417)

"Peel-Type" Rivet  
Diameter: 3/16"  
Grip: 1/32"-1/4"  
Flange Diameter: 1/2"  
Aluminum Rivet (Black) & Steel Mandrel (Zinc)  
Side Door Lock Attachment  
Mercury Villager 1995 - On

UNIT PACKAGE: 25



**11620**  
(GM: 9436175;  
Ford: 385189-S100;  
Chry: 6031115)

"Peel-Type" Rivet  
Diameter: 1/4"  
Grip: 1/32" - 9/64"  
Flange Diameter: 1/2"  
Aluminum Rivet & Steel Mandrel  
Window Regulators  
GM, Ford & Chrysler 1971 - On

UNIT PACKAGE: 25

### 16837

Same as 11620 except for unit package quantity

UNIT PACKAGE: 50

**Sec. 14****“PEEL - TYPE” SPECIALTY RIVETS**

Use 11817 Rivet Gun with 11853 Nose Piece  
(Page 295) to set all 1/4” “Peel-Type” Rivets



**19110**  
(W525172-S)

“Peel-Type” Rivet  
Diameter: 1/4”  
Grip: 1/32”-7/32”  
Flange Diameter: 1/2”  
Aluminum Rivet & Steel Mandrel (Zinc)  
Glass, Regulator Assembly  
& Remote Latch Assembly  
Ford Mustang & Lincoln Continental 1994 - On

UNIT PACKAGE: 25

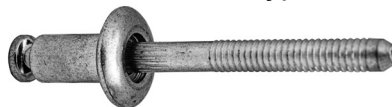

**15684**  
(20713843)

“Peel-Type” Rivet  
Diameter: 1/4”  
Grip: 7/64” - 11/64”  
Flange Diameter: 1/2”  
Recess under Head  
Aluminum Rivet & Steel Mandrel  
Used on Window Regulators  
& Door Lock Assemblies  
GM A & J Cars

UNIT PACKAGE: 25



**19461**  
(W525172-S417)

“Peel-Type” Rivet  
Diameter: 1/4”  
Grip: 1/32”-7/32”  
Flange Diameter: 1/2”  
Aluminum Rivet (Black) & Steel Mandrel (Zinc)  
Outside Door Handle  
Ford Crown Victoria, Econoline, Explorer,  
Grand Marquis, Ranger, Sable,  
Taurus & Windstar 1995 - On

UNIT PACKAGE: 15



**12655**  
(GM: 9437486;  
Chry: 6032926)

“Peel-Type” Rivet  
Diameter: 1/4”  
Grip: 9/64” - 3/16”  
Flange Diameter: 1/2”  
Aluminum Rivet & Steel Mandrel  
Window Regulators  
GM 1981 - On

UNIT PACKAGE: 25



**11852**  
(Ford: 388047-S100;  
GM: 14078435)

“Peel-Type” Rivet  
Diameter: 1/4”  
Grip: 5/64” - 7/64”  
Flange Diameter: 1/2”  
Recess under Head  
Aluminum Rivet & Steel Mandrel  
Attaches Outside Door Handle  
Ford 1978 - On  
Heat Shield Attachment  
GM

UNIT PACKAGE: 25



**14486**  
(GM: 9437486;  
Chry: 6032926)

“Peel-Type” Rivet  
Diameter: 1/4”  
Grip: 9/64” - 3/16”  
Flange Diameter: 1/2”  
Aluminum Rivet & Steel Mandrel  
Used on Window Regulators,  
Quarter Vent Handle Assemblies &  
Electrical Door Lock Linkage  
GM & Chrysler 1981 - On

UNIT PACKAGE: 25



**12653**  
(388047-S102)

“Peel-Type” Rivet  
Diameter: 1/4”  
Grip: 3/32”-1/8”  
Flange Diameter: 1/2”  
Aluminum Rivet (Black) & Steel Mandrel  
Door Handle Assembly  
Ford 1981 - On

UNIT PACKAGE: 25



**20402**  
(9437643)

“Peel-Type” Rivet  
Diameter : 1/4”  
Grip: 3/16” - 1/4”  
Flange Diameter: 1/2”  
Aluminum Rivet & Steel Mandrel (Zinc)  
Window Regulator  
Saturn 1993 - On

UNIT PACKAGE: 25

# "PEEL - TYPE" SPECIALTY RIVETS

Sec. 14

Use 11817 Rivet Gun with 11853 Nose Piece  
(Page 295) to set all 1/4" "Peel-Type" Rivets

## 11621

(Ford: 385323-S100; Chry: 6031091; GM: 9437938)

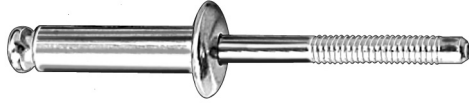

"Peel-Type" Rivet  
Diameter: 1/4"  
Grip: 33/64" - 19/32"  
Flange Diameter: 1/2"  
Aluminum Rivet & Steel Mandrel  
Window Regulator  
GM, Ford & Chrysler 1976 - On

UNIT PACKAGE: 10

## 16838

Same as 11621 except for unit package quantity

UNIT PACKAGE: 25

## 12658

(GM: 12338153, 20184399; Ford: 389268-S100)



"Peel-Type" Rivet  
Diameter: 1/4"  
Grip: 11/16" - 3/4"  
Flange Diameter: 1/2"  
Aluminum Rivet & Steel Mandrel  
Window Regulator  
GM & Ford 1979 - On

UNIT PACKAGE: 25

## 18396

(N808594-S100)  
Zinc & Yellow



"Peel-Type" Rivet  
Diameter: 1/4"  
Grip: 1/8"-5/16"  
Flange Diameter: 5/8"  
Aluminum Rivet & Steel Mandrel  
Door Lock Actuator  
Ford

UNIT PACKAGE: 25

## 19420

(W525174S)



"Peel-Type" Rivet  
Diameter: 1/4"  
Grip: 13/64"-13/32"  
Flange Diameter: 5/8"  
Aluminum Rivet & Steel Mandrel (Zinc)  
Door Handle  
Ford Ranger 1997 - On

UNIT PACKAGE: 25

## 19456

(W525175-S)



"Peel-Type" Rivet  
Diameter: 1/4"  
Grip: 25/64" - 21/32"  
Flange Diameter: 5/8"  
Aluminum Rivet & Steel Mandrel (Zinc)  
Front Door Window  
Ford Continental, Crown Victoria, Explorer, Grand  
Marquis, Mark VIII, Mustang, Ranger, Sable, Taurus,  
Town Car & Windstar 1996 - On

UNIT PACKAGE: 15

## 18167

(Ford: N804193-S100;  
GM: 9441592, 15672713)

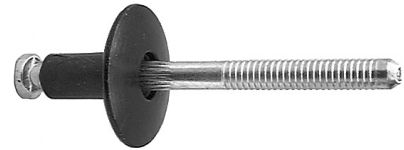

"Peel-Type" Rivet  
Diameter: 1/4"  
Grip: 3/32"-9/64"  
Flange Diameter: 3/4"  
Aluminum Rivet (Black) & Steel Mandrel  
Front Door Handle & Door Lock Actuator  
Tempo, Topaz, T-Bird & Cougar 1984 - On  
Rocker Panel Moulding  
Chevrolet Beretta & Corsica 1996 - 92

UNIT PACKAGE: 25

## 19458

(N808689-S417)

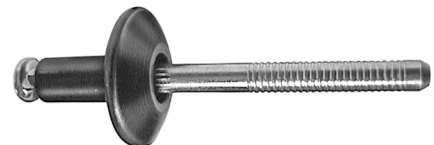

"Peel-Type" Rivet  
Diameter: 1/4"  
Grip: 1/8"-21/64"  
Flange Diameter: 3/4"  
Aluminum Rivet (Black) & Aluminum Mandrel  
Door Lock Actuator  
Ford Continental, Crown Victoria,  
F Series Truck, Grand Marquis, Mark VII, Mustang,  
Ranger, Sable, Taurus, Town Car & Windstar 1995 - On

UNIT PACKAGE: 10



**10658**

Diameter: 3/32"  
Grip: 1/8"-1/4"  
Flange Diameter: 3/16"  
Aluminum Rivet & Mandrel

**Replaces welded studs on body panels.**

UNIT PACKAGE: 100



**18499**

Diameter: 1/8"  
Grip: 1/8"-3/16"  
Flange Diameter: 3/16"  
Aluminum Rivet & Mandrel  
Trim Moulding Attachment

UNIT PACKAGE: 100



**18500**

Diameter: 1/8"  
Grip: 3/16"-1/4"  
Flange Diameter: 3/16"  
Aluminum Rivet & Mandrel  
Trim Moulding Attachment

UNIT PACKAGE: 100



**11104**

(Ford: 383229-S)

Diameter: 1/8"  
Grip: 3/16"-1/4"  
Flange Diameter: 3/16"

Stainless Steel Rivet & Steel Mandrel

**Replaces welded studs on body panels.  
Use Auveco Rivet Gun 7915 & Nose Piece 7981**

UNIT PACKAGE: 100

**11105**

Same as 11104 except for unit package quantity

UNIT PACKAGE: 500

**11106**

Same as 11104 except for unit package quantity

UNIT PACKAGE: 1000



**7981**

Rivet Gun Nose Piece  
**Used to set Auveco Rivet 11104  
with Rivet Gun 7915**

UNIT PACKAGE: 1



**20788**

(90269-04051,  
90269-A0006)

Diameter: 1/8" (3.2mm)  
Grip: 3/64" - 1/8" (1.2mm - 3.4mm)  
Flange Diameter: 15/64" (6mm)  
Aluminum Rivet with Plastic Cap  
Steel Mandrel

Lexus 1998 - On

UNIT PACKAGE: 10



**17408**

(N803933-S101)

Diameter: 1/8"  
Grip: 13/64"-9/32"  
Flange Diameter: 15/64"  
Closed End  
Black Aluminum Rivet & Mandrel  
Luggage Rack  
Ford

UNIT PACKAGE: 50



**17469**

(375936-S)

Diameter: 1/8"  
Grip: 1/32"-1/8"  
Flange Diameter: 1/4"  
Stainless Steel Rivet & Mandrel  
Attaches Body Side Mouldings  
Sets flush, does not leave a raised stud

UNIT PACKAGE: 100



**21418**

(6508540-AA)

Diameter: 1/8"  
Grip: 1/32" - 3/16"  
Flange Diameter: 1/4"  
Black Aluminum Rivet & Steel Mandrel (Zinc)  
Chrysler General Purpose

UNIT PACKAGE: 25



**18303**

Diameter: 1/8"  
Grip: 1/16"-1/8"  
Flange Diameter: 1/4"  
Aluminum Rivet (Black) & Aluminum Mandrel  
Attachment of Rear Window Trim Moulding  
Ford Explorer 1990-On

UNIT PACKAGE: 50



**17470**

(378527)

Diameter: 1/8"  
Grip: 1/8"-3/16"  
Flange Diameter: 1/4"  
Aluminum Rivet & Mandrel  
Attaches Climate Controls  
Ford

UNIT PACKAGE: 50



**17467**

(375203S)

Diameter: 1/8"  
Grip: 1/8"-3/16"  
Flange Diameter: 1/4"  
Stainless Steel Rivet & Steel Mandrel  
Attaches Body Side Moulding Retainer  
Sets flush, does not leave a raised stud  
Ford

UNIT PACKAGE: 100



# SPECIALTY RIVETS

# Sec. 14



**21114**  
(11610210)

Diameter: 1/8"  
Grip: 5/32" - 5/16"  
Flange Diameter: 1/4"  
Aluminum Rivet & Mandrel  
Rear Bumper Fascia  
Chevrolet Equinox 2005 - On

UNIT PACKAGE: 50



**19406**  
(6035414)

Diameter: 1/8"  
Grip: 1/16"-1/4"  
Flange Diameter: 5/16"  
Aluminum Rivet & Steel Mandrel (Zinc)  
Cladding to Fender Attachment  
Chrysler Concorde, Eagle & Intrepid  
1997 - On

UNIT PACKAGE: 50



**19202**

Diameter: 1/8"  
Grip: 3/16"-1/4"  
Flange Diameter: 1/4"  
Aluminum Rivet (Black) & Aluminum Mandrel  
GM & General Purpose

UNIT PACKAGE: 100



**12656**  
(20325696)

Diameter: 1/8"  
Grip: 1/8" - 3/16"  
Flange Diameter: 5/16"  
Aluminum Rivet & Steel Mandrel  
Rear Window Gasket Attachment  
GM 1981 - On

UNIT PACKAGE: 50



**19657**  
(6034848)  
Zinc & Yellow

Diameter: 1/8"  
Grip: 1/32"-3/16"  
Flange Diameter: 5/16"  
Aluminum Rivet & Steel Mandrel  
Rocker Panel & Cladding  
Chrysler LH Series 1993 - On

UNIT PACKAGE: 50



**20628**  
(90269-04050)

Diameter: 1/8" (3.2mm)  
Grip: 5/32" - 5/16" (4mm - 8mm)  
Flange Diameter: 5/16" (8mm)  
Aluminum Rivet with Plastic Cap  
Steel Mandrel  
Windshield, Side & Trunk Moulding  
Lexus GS300, 400, 430 & SC430  
1998 - On

UNIT PACKAGE: 15



**20787**  
(90269-04006)

Diameter: 1/8" (3.2mm)  
Grip: 3/64" - 5/32" (1.2mm - 4.0mm)  
Flange Diameter: 5/16" (8mm)  
Aluminum Rivet with Plastic Cap  
Steel Mandrel  
Lexus 1998 - On

UNIT PACKAGE: 10



**17615**  
(6032856)

Diameter: 1/8"  
Grip: 3/16"-3/8"  
Flange Diameter: 5/16"  
Aluminum Rivet (Black) & Steel Mandrel  
Body Side Moulding  
& Universal Applications  
Chrysler

UNIT PACKAGE: 50



**20627**  
(90269-04053)

Diameter: 1/8" (3.2mm)  
Grip: 3/64" - 3/16" (1mm - 4.8mm)  
Flange Diameter: 5/16" (8mm)  
Aluminum Rivet (Black) with Plastic Cap  
Steel Mandrel (Black)  
Mouldings  
Toyota Land Cruiser 1998 - On

UNIT PACKAGE: 10



**18304**

Diameter: 1/8"  
Grip: 1/16"-1/8"  
Flange Diameter: 3/8"  
Aluminum Rivet (Black) & Steel Mandrel  
Attachment of Door Glass Moulding  
Ford 1993 - On

UNIT PACKAGE: 50



**21320**  
(90269-03064)

Diameter: 3.2mm (1/8")  
Grip: 1.6mm-3.2mm (1/16"-1/8")  
Flange Diameter: 9.5mm (3/8")  
Aluminum Rivet & Mandrel  
Black Flange  
Rocker Moulding  
Lexus ES 300 & Others 2002 - On

UNIT PACKAGE: 15



**16834**  
(N805759-S100)

Diameter: 1/8"  
Grip: 1/8"-3/16"  
Flange Diameter: 3/8"  
Aluminum Rivet (Black) & Aluminum Mandrel  
Windshield Side Rail  
Ford T-Bird & Mercury Cougar 1989-On

UNIT PACKAGE: 50



**16686**  
(9432552)

Multi-Purpose Rivet  
Diameter: 1/8"  
Grip: 1/8" - 3/16"  
Flange Diameter: 3/8"  
Aluminum Rivet & Steel Mandrel  
Large Flange  
GM 1978-On

UNIT PACKAGE: 100



**19419**  
(N811460-S100)

Diameter: 1/8"  
Grip: 1/8"-3/16"  
Flange Diameter: 3/8"  
Steel Rivet (Black) & Steel Mandrel  
Door Moulding  
Ford Taurus 1996-On

UNIT PACKAGE: 15



**21082**  
(75547-51021)

Diameter: 1/8" (3.2mm)  
Nylon Shoulder Diameter: 1/4" (6.3mm)  
Grip: 1/32" - 1/16" (.8mm - 1.5mm)  
Flange Diameter: 13/32" (10.3mm)  
Aluminum Rivet with Plastic Cap  
Steel Mandrel  
Windshield  
Lexus IS 250, IS 350 & IS F 2006 - On  
Toyota 2002 - On

UNIT PACKAGE: 15



**21714**  
(Lexus: 90269-04060)

Specialty Rivet  
Diameter: 5/32" (4mm)  
Grip: 3/64" - 9/32" (1mm - 7mm)  
Flange Diameter: 15/64" (6mm)  
Steel Rivet & Mandrel  
Lexus GS 300, GS 350, GS 430, GS 450h  
& GS 460 2006 - On

UNIT PACKAGE: 25



**22089**  
(GM: 92139150)

Front Bumper & Grille Specialty Rivet  
Diameter: 5/32" (4mm)  
Grip Range: 11/64" - 11/32" (4.4mm - 8.5mm)  
Flange Diameter: 9/32" (7.1mm)  
Aluminum Rivet & Stainless Steel Mandrel  
Chevrolet Camaro 2012 - On

UNIT PACKAGE: 25



**22173**  
(GM: 11611651)

Zinc & Clear Trivalent  
Door & Exterior Trim Specialty Rivet  
Diameter: 5/32" (4mm)  
Grip Range: 3/64" - 5/32" (1mm - 4mm)  
Flange Diameter: 5/16" (8mm)  
Steel Rivet & Mandrel  
Cadillac ATS, CTS, CTS-V & Escalade,  
Chevrolet Avalanche, Camaro & Equinox and  
GMC Terrain 2010 - On

UNIT PACKAGE: 50

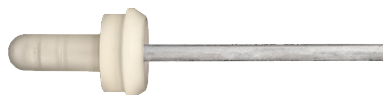

**22332**  
(Subaru: 905920039;  
Toyota: 76879-48010)

Roof, Liftgate & Exterior Trim  
Specialty Rivet with Plastic Cap  
Rivet Diameter: 4mm (5/32")  
Diameter of Plastic Cap: 5mm  
Flange Diameter: 8mm (5/16")  
Plastic Cap Flange Diameter:  
10mm (Top), 12mm (Bottom)  
Grip Range: .8mm - 2.4mm (.031" - .094")  
Aluminum Rivet, Steel Mandrel  
Subaru Forester, Impreza, Legacy,  
Outback & XV Crosstrek 2015 - 2009  
Toyota Prius 2009 - 2004

UNIT PACKAGE: 10

## 18461

(Ford: N807620-S100; GM: 10131511)



Split-Type Rivet  
Diameter: 5/32"  
Grip: 3/64"-1/4"  
Flange Diameter: 5/16"  
Aluminum Rivet (Black) & Aluminum Mandrel  
Wheel Openings  
Lincoln 1994-On  
Bumper Cover, Grille & Rocker Moulding  
GM 1997 - On

UNIT PACKAGE: 25

## 20971

(Mazda: BBM450-355;  
Mercedes-Benz: 003-990-94-97)



Split-Type Rivet  
Diameter: 5/32" (4mm)  
Grip: 3/64" - 9/32" (1mm - 7mm)  
Flange Diameter: 5/16" (8mm)  
Aluminum Rivet & Mandrel  
Mazda 2012 - On  
Mercedes-Benz 2004 - On

UNIT PACKAGE: 25



## 21113

(01515-0009U)

Split-Type Rivet  
Diameter: 5/32" (4mm)  
Grip: 3/64" - 9/32" (1mm - 7mm)  
Flange Diameter: 5/16" (8mm)  
Aluminum Rivet (Black) & Aluminum Mandrel  
Bumper  
Nissan Pathfinder 2006 - On

UNIT PACKAGE: 25



## 20383

(90084-26002)

Diameter: 5/32" (4mm)  
Grip: 1/16" - 1/4" (1.6mm - 6.3mm)  
Flange Diameter: 5/16" (8mm)  
Aluminum Rivet & Mandrel  
Door Window Moulding  
Toyota Camry 1997 - On

UNIT PACKAGE: 50

## 16687

(GM: 9432137;  
Chry: 6032138)



Diameter: 5/32"  
Grip: 1/8" - 3/16"  
Flange Diameter: 5/16"  
Aluminum Rivet & Steel Mandrel  
Countersunk Head  
Trunk Lock Swivel Emblem Rivet  
GM 1973-On

UNIT PACKAGE: 25

## 21864

(Ford: W713819-S900)



Specialty Rivet  
Diameter: 5/32" (4mm)  
Grip: 3/64" - 1/8" (1.2mm - 3.2mm)  
Flange Diameter: 3/8" (9mm)  
Aluminum Rivet (Black) with Plastic Cap  
Steel Mandrel  
Cab & Exterior Trim  
Ford F-150 2014 - 2009

UNIT PACKAGE: 25



## 20629

(6036148-AA)

Split-Type Rivet  
Diameter: 5/32"  
Grip: 3/64" - 1/4"  
Flange Diameter: 7/16"  
Aluminum Rivet (Black) & Aluminum Mandrel  
Front Bumper, Trim Panel,  
Instrument Panel & Running Boards  
Chrysler 1999 - On

UNIT PACKAGE: 25



## 22088

(GM: 9132667)

Front & Rear Bumper Specialty Rivet  
Diameter: 5/32" (4mm)  
Grip Range: 9/64" - 3/8" (3.6mm - 9.5mm)  
Flange Diameter: 7/16" (11.1mm)  
Aluminum Rivet & Stainless Steel Mandrel  
Buick Regal & Verano; Chevrolet Avalanche, Camaro,  
Cruze, Malibu, Sonic & Volt 2010 - On

UNIT PACKAGE: 25



## 17468

(16715497)

Diameter: 5/32"  
Grip: 3/64"-1/4"  
Flange Diameter: 15/32"  
Aluminum Rivet & Steel Mandrel  
Attaches Support Rails to Load Floor  
GM

UNIT PACKAGE: 50



**21742**  
(Toyota: 90269-06054)

Specialty Rivet  
Diameter: 5/32" (4mm)  
Grip: 3/64" - 3/8" (1mm - 9.5mm)  
Flange Diameter: 15/32" (12mm)  
Aluminum Rivet (Black) & Steel Mandrel (Black)  
European Toyota and Universal

UNIT PACKAGE: 25



**21715**  
(Toyota: 90269-04047)

Specialty Rivet  
Diameter: 5/32" (4mm)  
Grip: 3/64" - 15/32" (1mm - 12mm)  
Flange Diameter: 15/32" (12mm)  
Aluminum Rivet & Steel Mandrel (Black)  
Black Flange  
Toyota RAV4 & 4Runner 1996 - On

UNIT PACKAGE: 25



**19376**  
(979878-6)

Diameter: 5/32" (4mm)  
Grip: 1/8" - 11/32" (3mm-8.5mm)  
Flange Diameter: 15/32" (12mm)  
Aluminum Rivet (Black Polyethylene Coating)  
Aluminum Mandrel  
Bumper & Wheel Housing  
Volvo 1993-On

UNIT PACKAGE: 15



**17006**  
(N900-845-01)

Diameter: 5/32"  
Grip: 1/4" - 3/8"  
Flange Diameter: 15/32"  
Aluminum Rivet (Black) & Steel Mandrel  
Wheel Opening Moulding Attachment  
Jetta, Rabbit & Golf

UNIT PACKAGE: 25



**15187**  
(N804583S)  
Black Nylon

Cowl Vent Grille  
Retainer Rivet  
Diameter: 5/32" (4mm)  
Grip: 15/64" - 13/32" (6mm-10.5mm)  
Flange Size: 11/32" x 5/8" (8.5mm x 15.5mm)  
Ford Aerostar 1986-On

UNIT PACKAGE: 25



**18169**  
(15956062)

Diameter: 3/16"  
Grip: 1/8"-1/4"  
Flange Diameter: 11/32"  
Aluminum Rivet & Steel Mandrel  
Door Assembly  
GM Trucks C, K Models 1994-On

UNIT PACKAGE: 25



**19514**  
(10125439, 10201332)

Split-Type Rivet  
Diameter: 3/16"  
Grip: 3/64" - 15/64"  
Flange Diameter: 3/8"  
Aluminum Rivet (Black) & Aluminum Mandrel  
Door Actuator, Door, Body & Fender  
Moulding and Dash Panel Insulation  
Buick Regal, Chevrolet Lumina APV, K & T Trucks,  
Olds Silhouette and Pontiac Trans Sport 1990 - On

UNIT PACKAGE: 25



**16864**  
(10125439)

Split-Type Rivet  
Diameter: 3/16"  
Grip: 3/64" - 11/32"  
Flange Diameter: 3/8"  
Aluminum Rivet (Black) & Aluminum Mandrel  
Moulding Attachment  
APV Vans 1990 - On

UNIT PACKAGE: 25



**22333**  
(Ford: W717984-S417)

Cab & Exterior Trim Countersunk  
Closed End Specialty Rivet  
Diameter: 4.8mm (3/16")  
Flange Diameter: 9.5mm (3/8")  
Grip Range: 1.6mm - 3.18mm (.063" - .125")  
Black Aluminum Rivet & Mandrel  
Ford F-150 2015 - On

UNIT PACKAGE: 15



**20830**  
(N-904-374-01)

Diameter: 3/16" (4.8mm)  
Grip: 1/16" - 1/4" (1.6mm-6.4mm)  
Flange Diameter: 3/8" (10mm)  
Aluminum Rivet & Steel Mandrel  
Inner Fender  
Volkswagen

UNIT PACKAGE: 25



**18912**  
(22585836, 22641917)

Diameter: 3/16"  
Grip: 1/16" - 17/64"  
Flange Diameter: 3/8"  
Steel Rivet (Black) & Steel Mandrel (Zinc)  
Rear Side Door Outside Handle Attachment  
Cadillac DeVille & Seville, Chevrolet Cavalier and  
Pontiac Sunfire 1994 - On

UNIT PACKAGE: 25



**17410**  
(390428-S100)

Diameter: 3/16"  
Grip: 3/8" - 1/2"  
Flange Diameter: 3/8"  
Closed End  
Black Aluminum Rivet & Mandrel  
Luggage Rack  
Ford

UNIT PACKAGE: 25



**19459**  
(384432-S)

Diameter: 3/16"  
Grip: 1/16" - 1/8"  
Flange Diameter: 3/8"  
Aluminum Rivet & Steel Mandrel  
Outer Moulding  
Ford F Series & Villager  
and Nissan Quest 1995 - On

UNIT PACKAGE: 25



**19515**  
(15704030)

Diameter: 3/16"  
Grip: 3/16" - 3/8"  
Flange Diameter: 25/64"  
Aluminum Rivet (Black)  
Steel Mandrel (Zinc & Yellow)  
Body Moulding, Bumper Fascia,  
Hood Prop Rod and Window Hinge  
Chev. Beretta, Camaro, Corsica &  
Trucks, Olds Silhouette, Pontiac Firebird,  
Grand Am and Trans Sport 1992 - On

UNIT PACKAGE: 25



**21184**  
(003-990-24-97)

Door Handle, Air Bag, Rocker Moulding &  
Window Regulator Rivet  
Diameter: 3/16" (4.8mm)  
Grip: 1/16" - 1/8" (1.6mm - 3.2mm)  
Flange Diameter: 3/8" (9.5mm)  
Steel Rivet & Mandrel  
Mercedes-Benz 1998 - On

UNIT PACKAGE: 100



**17121**  
(GM: 25618730;  
Ford: N805592-S100)

Split-Type Rivet  
Diameter: 3/16"  
Grip: 5/64" - 15/64"  
Flange Diameter: 7/16"  
Aluminum Rivet (Black) & Aluminum Mandrel  
Wheel House Moulding & General Purpose

UNIT PACKAGE: 25



**21439**

Diameter: 114.8 (3/16")  
Grip: 1.5mm - 6mm (1/16" - 15/64")  
Flange Diameter: 9mm (3/8")  
Steel Rivet & Mandrel  
Cadillac CTS; Chevrolet Colorado &  
Equinox and GMC Canyon & Terrain 2004 - On

UNIT PACKAGE: 50



**18927**  
(22569178,  
22579423)

Split-Type Rivet  
Diameter: 3/16"  
Grip: 5/16" - 7/16"  
Flange Diameter: 7/16"  
Aluminum Rivet & Steel Mandrel (Zinc)  
Front & Rear Door Window Sash Attachment  
Buick Skylark, Chevrolet Cavalier,  
Olds Achieva & Pontiac Grand Am 1992-On

UNIT PACKAGE: 25



**18329**  
(3828472)

Diameter: 3/16"  
Grip: 1/4" - 3/8"  
Flange Diameter: 3/8"  
Aluminum Rivet (Black) & Aluminum Mandrel  
Attachment of Front Fender Lower Rocker Moulding  
Chevrolet Astro & GMC Safari Mini-Vans 1995 - On

UNIT PACKAGE: 50



**18244**  
(GM:  
15614774)

Split-Type Rivet  
Diameter: 3/16"  
Grip: 3/16"-3/8"  
Flange Diameter: 29/64"  
Aluminum Rivet (Black) & Aluminum Mandrel  
For Camper Style Mirrors on GM Trucks

UNIT PACKAGE: 10



**21713**  
(Toyota: 90269-05034,  
90269-05056)

Specialty Rivet  
Diameter: 3/16" (5mm)  
Grip: 3/64" - 15/32" (1mm - 12mm)  
Flange Diameter: 1/2" (13mm)  
Aluminum Rivet with Plastic Cap  
Steel Mandrel  
Lexus IS 300 and Toyota Celica, Corolla,  
Matrix, Prius, RAV4, Tercel & Yaris 2000 - On

UNIT PACKAGE: 25



**21046**  
(90269-05065)

Diameter: 3/16" (5mm)  
Grip: 5/32" - 9/32" (4mm - 7mm)  
Flange Diameter: 1/2" (13mm)  
Aluminum Rivet with Plastic Cap  
Steel Mandrel  
Bumpers & General Purpose  
Lexus 2004 - On

UNIT PACKAGE: 10



**17641**  
(9442361, 25609048)

Diameter: 3/16"  
Grip: 3/64"-13/64"  
Flange Diameter: 9/16"  
Aluminum Rivet (Black) & Steel Mandrel (Zinc)  
Used in place of screws when attaching  
new Catalytic Converter Heat Shield  
Buick LeSabre & Roadmaster, Cadillac Brougham  
and Oldsmobile 98 & 88 1986 - On

UNIT PACKAGE: 25



**18749**  
(9439559,  
21021319)

Diameter: 3/16"  
Grip: 1/16"-1/4"  
Flange Diameter: 9/16"  
Aluminum Rivet (Black) & Steel Mandrel  
Rocker Panel Cover  
GM Saturn 1991 - On

UNIT PACKAGE: 50



**20834**  
(90269-06013)

Diameter: 3/16" (4.8mm)  
Grip: 1/16" - 1/4" (1.6mm - 6.35mm)  
Flange Diameter: 9/16" (14mm)  
Aluminum Rivet with Plastic Cap  
Steel Mandrel  
Gas Filler Door  
Toyota Camry & Lexus IS300 2001 - On

UNIT PACKAGE: 15



**20626**  
(90269-05054)

Diameter: 3/16" (5mm)  
Grip: 1/8" - 5/16" (3mm - 8mm)  
Flange Diameter: 9/16" (14mm)  
Aluminum Rivet with Plastic Cap  
Steel Mandrel  
Windshield Side Moulding & Gas Filler Cap  
Toyota Camry & Sienna 1997 - On

UNIT PACKAGE: 10



**14127**  
(388664-S100)

Diameter: 3/16"  
Grip: 3/8"-1/2"  
Flange Diameter: 9/16"  
Aluminum Rivet (Black) & Aluminum Mandrel  
Fascia & Bumper  
Ford 1982 - On

UNIT PACKAGE: 25

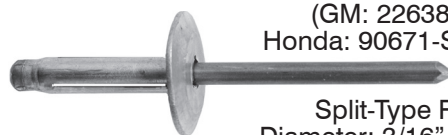

**20740**  
(GM: 22638717;  
Honda: 90671-SDA-A01)

Split-Type Rivet  
Diameter: 3/16" (4.8mm)  
Grip Range: 3/64"- 23/64" (1mm - 9mm)  
Flange Diameter: 5/8" (16mm)  
Aluminum Rivet & Mandrel  
Bumper Fascia & General Purpose  
GM 1987 - On  
Honda Civic 2016 - On

UNIT PACKAGE: 25

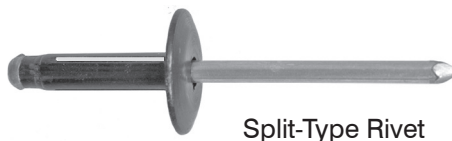

**20741**  
(11516807)

Split-Type Rivet  
Diameter: 3/16" (4.8mm)  
Grip: 3/64" - 23/64" (1mm-9mm)  
Flange Diameter: 5/8" (16mm)  
Aluminum Rivet (Black) & Aluminum Mandrel  
Bumper Fascia & General Purpose  
GM 1990 - On

UNIT PACKAGE: 25



**21799**  
 Split-Type Rivet  
 Diameter: 3/16"  
 Grip Range: 7/64" - 3/8"  
 Flange Diameter: 5/8"  
 Aluminum Rivet & Mandrel  
 General Purpose  
 UNIT PACKAGE: 15



**19460**  
 (385974-S)  
 Diameter: 3/16"  
 Grip: 3/16"-1/4"  
 Flange Diameter: 5/8"  
 Aluminum Rivet & Steel Mandrel  
 General Purpose  
 Ford Econoline & Windstar 1995 - On  
 UNIT PACKAGE: 50



**22264**  
 (Ford:W714004-S900)  
 Liftgate, Exterior Trim & Quarter Panel Specialty Rivet  
 Diameter: 3/16" (4.8mm)  
 Grip Range: 3/16" - 3/8" (4.75mm - 9.53mm)  
 Flange Diameter: 7/16" (11mm)  
 Black Aluminum Rivet & Aluminum Mandrel  
 Ford Explorer & Flex 2009 - On  
 UNIT PACKAGE: 25



**18168**  
 (9433186)  
 Diameter: 3/16"  
 Grip 1/4"-3/8"  
 Flange Diameter: 5/8"  
 Steel Rivet (Zinc) & Steel Mandrel  
 Front & Rear Bumper  
 GM Saturn 1991 - On  
 UNIT PACKAGE: 50



**12657**  
 (9439719)  
 Diameter: 3/16"  
 Grip: 1/4"-3/8"  
 Flange Diameter: 5/8"  
 Steel Rivet (Black) & Steel Mandrel  
 Attaches Fascia to Underside Bumper  
 GM 1981 - On  
 UNIT PACKAGE: 50



**16940**  
 (GM: 2085119, 3533539, 3540161;  
 Not Supplied by Chrysler O.E.M.)  
 Diameter: 3/16"  
 Grip: 1/2" - 5/8"  
 Flange Diameter: 5/8"  
 Aluminum Rivet & Mandrel  
 Glass Stop/Roller Rivet  
 Chrysler  
 Front Bumper Fascia Lower Deflector  
 Cadillac 1993 - 87  
 UNIT PACKAGE: 25



**17466**  
 (N905150-S)  
 Diameter: 3/16"  
 Grip: 1/2"-5/8"  
 Flange Diameter: 5/8"  
 Aluminum Rivet & Steel Mandrel  
 Attaches License Plate Bracket  
 Ford  
 UNIT PACKAGE: 25



**18935**  
 (10160960)  
 Diameter: 3/16"  
 Grip: 1/2" - 25/32"  
 Flange Diameter: 5/8"  
 Aluminum Rivet & Steel Mandrel (Zinc)  
 Liftgate Strut Gate Side Bracket  
 Lumina APV, Silhouette & Trans Sport 1992 - On  
 UNIT PACKAGE: 25



**17977**  
 (Not Supplied by O.E.M.)  
 Diameter: 3/16"  
 Grip: 5/8"-3/4"  
 Flange Diameter: 5/8"  
 Aluminum Rivet & Mandrel  
 Glass Stop/Roller Rivet  
 Chrysler  
 UNIT PACKAGE: 25



**19111**  
 (N807168-S)  
 Diameter: 3/16"  
 Grip: 11/16"-13/16"  
 Flange Diameter: 3/4"  
 Aluminum Rivet & Mandrel  
 Grille & Bumper  
 Ford Windstar 1995 - On  
 UNIT PACKAGE: 25

**22122**

(Mercedes: 003-990-35-97)



Specialty Rivet  
Diameter: 6.3mm (1/4")  
Grip Range: 1.0mm - 8.5mm (.039" - .335")  
Flange Diameter: 11mm (7/16")  
Aluminum Rivet & Steel Mandrel  
Mercedes 2012 - 1990

UNIT PACKAGE: 15

**21124**

(11610383)



Diameter: 1/4"  
Grip: 1/64" - 1/8"  
Flange Outer Diameter: 1/2"  
Steel Rivet (Zinc) & Steel Mandrel  
Step Bumper  
GM Silverado & Sierra Pick-Ups 2007 - On

UNIT PACKAGE: 25

**22266**

(GM: 11561334)  
Zinc



Rear Compartment, Rocker & Wheelhouse Specialty Rivet  
Diameter: 1/4" (6.3mm)  
Grip Range: .059" - .138" (1.48mm - 3.50mm)  
Flange Diameter: 1/2" (12.70mm)  
Steel Rivet & Mandrel  
Various GM Models, Cadillac CTS & SRX 2015 - 2009  
Cadillac CT6 2016 - On

UNIT PACKAGE: 15

**HAVE YOU VISITED US ONLINE?**

Auveco's website has been completely renovated. Our new design is user friendly with easy navigation and ordering.

Product is searchable by car make, OEM number and category, as well as, several attribute drop downs within individual categories. All product also has stock availability listed.

Make sure to head over to [www.auveco.com](http://www.auveco.com) to receive up to date information on all our products.

**22067**

(Ford: W707638-S900C)  
Zinc



Cab, Rear Body, Floor, Door, Box, Wheel House & Back Panel Specialty Rivet  
Diameter: 1/4" (6.3mm)  
Grip: .060"-.138" (1.5mm - 3.5mm)  
Flange Diameter: 1/2" (13mm)  
Steel Rivet & Mandrel  
Ford F-150 Trucks with Aluminum Body 2015 - On

UNIT PACKAGE: 10

**18889**

(22643056)  
Zinc & Yellow Dichromate



Diameter: 1/4"  
Grip: 1/16" - 5/32"  
Flange Diameter: 1/2"  
Steel Rivet & Mandrel  
Door Window Regulator  
Buick Skylark, Chevrolet Cavalier, Olds Achieva & Aurora, and Pontiac Grand Am & Sunfire 1995-On

UNIT PACKAGE: 25

**21315**

(90269-A0005, 90269-06017)



Diameter: 1/4" (6.3mm)  
Grip: 1/16" - 3/16" (1.6mm - 4.8mm)  
Flange Diameter: 1/2" (13mm)  
Aluminum Rivet (Black) & Steel Mandrel  
Fuel Door & General Purpose  
Toyota and Lexus 2000 - On  
Scion 2005 - On

UNIT PACKAGE: 10

**18938**

(2024778)  
Zinc

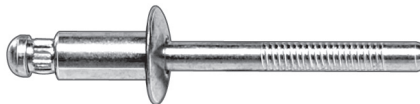

Diameter: 1/4"  
Grip: 1/16"-1/4"  
Flange Diameter: 1/2"  
Steel Rivet & Mandrel  
Front Side Door Window Regulator  
Chevrolet Lumina APV, Olds Silhouette & Pontiac Trans Sport 1990 - On

UNIT PACKAGE: 25



## 16939

(10157547)

Yellow Dichromate Coated



Diameter: 1/4"  
Grip: 5/64" - 3/8"  
Flange Diameter: 1/2"  
Aluminum Rivet & Steel Mandrel  
Front Door Window Regulator  
GM APV Vans 1990 - On

UNIT PACKAGE: 10

## 18810

(6033688)

Zinc & Yellow



Diameter: 1/4"  
Grip: 7/64" - 3/16"  
Flange Diameter: 1/2"  
Steel Rivet & Mandrel  
Glass & Frame Assembly and  
Floor Pan Reinforcement Attachment  
Dodge Shadow, Plymouth Sundance  
& Jeep Cherokee 1991 - On

UNIT PACKAGE: 25

## 22023

(Ford: W702512-S900C)

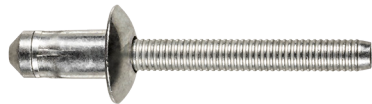

Fender, Sill & Radiator Support Specialty Rivet  
Diameter: 1/4" (6.3mm)  
Grip: .110" - .189" (2.79mm - 4.8mm)  
Flange Diameter: 1/2" (13mm)  
Steel Rivet & Mandrel  
Ford F-150 Trucks with Aluminum Body 2015

UNIT PACKAGE: 10

## 12654

(372820-S36, S40)



Diameter: 1/4"  
Grip: 1/8" - 1/4"  
Flange Diameter: 1/2"  
Steel Rivet (Zinc & Gold Chrome) & Steel Mandrel  
Front Bumper Assembly  
Ford 1979 - On

UNIT PACKAGE: 25

## 22265

(Mercedes: 000-991-59-32)



Front & Rear Door Specialty Rivet  
Diameter: 6.3mm (1/4")  
Grip Range: 3.5mm - 6.5mm (.138" - .265")  
Flange Diameter: 16mm (5/8")  
Aluminum Rivet & Steel Mandrel  
Mercedes-Benz CLA & GLA Class 2014 - On

UNIT PACKAGE: 15

## 21286

(Ford: W708777-S900C;

Mercedes: 004-990-16-97)

Zinc



Specialty Rivet  
Diameter: 1/4" (6.3mm)  
Grip: 3/16" - 17/64" (4.80mm - 6.80mm)  
Flange Diameter: 1/2" (13mm)  
Steel Rivet & Mandrel  
Cab, Radiator, Rail, Floor, Door, Pillar,  
Cowl, Box & Back Panel  
Ford F-150 Trucks with Aluminum Body 2015 - On  
Mercedes Benz 2008 - On

UNIT PACKAGE: 10

## 22066

(Ford: W702554-S900C)

Zinc



Cab, Floor, Door, Pillar, Box &  
Cowl Specialty Rivet  
Diameter: 1/4" (6.3mm)  
Grip: .268" - .346" (6.8mm - 8.8mm)  
Flange Diameter: 1/2" (13mm)  
Steel Rivet & Mandrel  
Ford F-150 Trucks with  
Aluminum Body 2015 - On

UNIT PACKAGE: 10

**21245**

(W705297-S300)

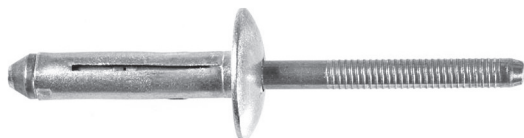

Split-Type Rivet  
Diameter: 1/4"  
Grip Range: 3/16" - 3/8"  
Flange Diameter: 11/16"  
Aluminum Rivet & Mandrel  
Bumper Cover  
Ford Fusion 2009 - On

UNIT PACKAGE: 15

**21440**

(Not Available from O.E.M.)



Closed End Rivet  
Diameter: 1/4"  
Grip Range: 1/4" - 3/8"  
Flange Diameter: 1/2"  
Aluminum Rivet & Steel Mandrel  
General Purpose

UNIT PACKAGE: 25

**18170**

(10204266)



Diameter: 1/4"  
Grip: 3/4"-1"  
Flange Diameter: 1/2"  
Aluminum Rivet & Mandrel  
Trunk Lock Cylinder  
Pontiac Firebird 1994 - On

UNIT PACKAGE: 10

**19516**

(N804851-S100)



Split-Type Rivet  
Diameter: 1/4"  
Grip: 3/64"-1/4"  
Flange Diameter: 9/16"  
Aluminum Rivet (Black) & Aluminum Mandrel  
Front Bumper  
Ford Taurus 1996 - On

UNIT PACKAGE: 15

**17639**

(Ford: N806830-S100;  
Chry: 6035201)



Split-Type Rivet  
Diameter: 1/4"  
Grip: 3/16"-3/8"  
Flange Diameter: 11/16"  
Aluminum Rivet & (Black) Aluminum Mandrel  
Attachment of Bumper Cover to Bumper &  
Front License Plate Bracket to Bumper Cover  
Ford 1992 - On  
Air Dam to Fascia  
Chrysler 1993 - On

UNIT PACKAGE: 15

**19263**

Same as 17639 except for unit package quantity

UNIT PACKAGE: 25

**18331**

(N805995-S100,  
W701566-S417)



Diameter: 1/4"  
Grip: 1/32"-7/32"  
Flange Diameter: 3/4"  
Aluminum Rivet (Black) & Aluminum Mandrel (Yellow)  
Attachment of Power Door Lock Actuator  
Mustang & Lincoln Continental 1994-On

UNIT PACKAGE: 10

**12652**

(388442-S100)



Diameter: 1/4"  
Grip: 1/8"-1/4"  
Flange Diameter: 3/4"  
Steel Rivet (Black) & Steel Mandrel  
Bumper Assembly  
Escort & Lynx 1981 - On

UNIT PACKAGE: 25

## Straight Shank 135° Split Point Black Finish



Auveco Part No.	Unit Pkg.	Size	Dec. Equiv.	Flute Length	Overall Length
13039	5	3/32"	.0938	1-1/4"	2-1/4"
13040	5	7/64"	.1094	1-1/2"	2-5/8"
13041	5	1/8"	.1250	1-5/8"	2-3/4"
13095	5	30	.1285	1-5/8"	2-3/4"
13042	5	9/64"	.1406	1-3/4"	2-7/8"
13043	5	5/32"	.1562	2"	3-1/8"
13044	5	11/64"	.1719	2-1/8"	3-1/4"
13045	5	3/16"	.1875	2-5/16"	3-1/2"
13046	5	13/64"	.2031	2-7/16"	3-5/8"
13047	5	7/32"	.2188	2-1/2"	3-3/4"
13048	5	15/64"	.2344	2-5/8"	3-7/8"
13049	5	1/4"	.2500	2-3/4"	4"
13050	5	17/64"	.2656	2-7/8"	4-1/8"
13051	5	9/32"	.2812	2-15/16"	4-1/4"
13052	5	19/64"	.2969	3-1/16"	4-3/8"
13053	5	5/16"	.3125	3-3/16"	4-1/2"
13054	5	21/64"	.3281	3-5/16"	4-5/8"
13055	5	11/32"	.3438	3-7/16"	4-3/4"
13056	5	23/64"	.3594	3-1/2"	4-7/8"
13057	5	3/8"	.3750	3-5/8"	5"
13058	5	25/64"	.3906	3-3/4"	5-1/8"
13059	5	13/32"	.4062	3-7/8"	5-1/4"
13060	5	27/64"	.4219	3-15/16"	5-3/8"
13061	5	7/16"	.4375	4-1/16"	5-1/2"
13062	5	29/64"	.4531	4-3/16"	5-5/8"
13063	5	15/32"	.4688	4-5/16"	5-3/4"
13064	5	31/64"	.4844	4-3/8"	5-7/8"
13065	3	1/2"	.5000	4-1/2"	6"

## Cobalt Steel Spot Weld Drills



Auveco Part No.	Unit Pkg.	Size	Flute Length	Overall Length
20479	3	8mm (5/16")	27mm (1-1/16")	58mm (2-1/4")
20480	3	10mm (3/8")	27mm (1-1/16")	58mm (2-1/4")

## High Speed Jobber Length Drill Set Metal Drill Indexes



### 13136

Jobbers Length Straight Shank  
135° Split Point  
Sizes 1/16" thru 1/2" by 64th  
29 Pieces

UNIT PACKAGE: 1 Set

## Screw Machine Length Drills 135° Split Point Straight Shank • Black Finish



Auveco Part No.	Unit Pkg.	Size	Dec. Equiv.	Flute Length	Overall Length
13120	5	1/16"	.0625	5/8"	1-5/8"
13121	5	5/64"	.0781	11/16"	1-11/16"
13124*	5	1/8"	.1250	7/8"	1-7/8"
13128	5	3/16"	.1875	1-1/8"	2-3/16"
13132	5	1/4"	.2500	1-3/8"	2-1/2"
13133	5	5/16"	.3125	1-5/8"	2-13/16"
13134	2	3/8"	.3750	1-13/16"	3-1/8"

\* For 1/8" Pop Rivets

### 12676 Black Finish



Double-End Drill Bit  
135° Split Point  
Diameter: 1/8" (.125)  
Length: 2"

UNIT PACKAGE: 5

## AuvecoPak AP448 Retail Merchandiser

AuvecoPak part numbers are the same as standard Auveco part numbers with an “AP” prefix. Thus AP11146 is the AuvecoPak version of 11146.

**AP448S (Starter Merchandiser):** One package each of 448 part numbers

**AP448L (Large Merchandiser):** Two packages each of the 224 most popular items and one package each of the other 224 part numbers for a total of 672 packages.



The AuvecoPak merchandisers (AP448S and AP448L) provide 448 of the fastest moving, most popular automotive body hardware and specialty fasteners.

Each of the 7 panels contains 32 part numbers per side.

The AP448S (Starter Merchandiser) consists of one package each of the 448 part numbers. The AP448L (Large Assortment) includes two packages each of the 224 most popular items and one package each of the other 224 part numbers for a total of 672 packages.

Two header signs identify the AP448 as an Auveco merchandiser, along with the phrase automotive body hardware and specialty fasteners. Eye-catching color scheme and graphics make the merchandiser visually appealing and portray the contents of the merchandiser.

Initial set-up is easy. The panels come “pre-dressed” with the AuvecoPaks already in place. Simply position the top and bottom brackets on a gondola or pegboard wall. Insert the panels into the brackets.

An individual panel measures 6-1/2” (wide) x 17-1/2” (front to back) x 44-1/2” (high). Merchandisers (AP448S and AP448L) fit on a gondola with 48” x 48” of pegboard or on any pegboard wall.

**A gondola is not included with the AP448S or the AP448L. Auveco customer service reps can recommend a source for gondolas.**

AuvecoPak packages feature, contemporary graphics with all the necessary application and descriptive information in trilingual verbiage (English, Spanish and French-Canadian).

Re-ordering is a breeze, the AuvecoPak part number and UPC-A bar code are on the panel back-up boards beneath each hook. Restocking the merchandiser is also quick and easy with the AuvecoPak packages’ locator codes identifying their specific location on the panels.



*Refer to contents listing for each panel on following pages*

# AuvecoPak AP448

## Retail Merchandiser Contents

Sec. 15

AuvecoPak part numbers are the same as standard Auveco part numbers with an "AP" prefix. Thus AP11146 is the AuvecoPak version of 11146. *Photos not actual size.*

### Panel T1 Retainers

AP10832	AP10831	AP11146	AP17664
AP20192	AP11120	AP14921	AP14021
AP11612	AP11721	AP15367	AP17612
AP11679	AP19837	AP16818	AP12731
AP18301	AP14032	AP14036	AP12766
AP15543	AP20366	AP20316	AP11351
AP20362	AP12137	AP15481	AP15480
AP12571	AP12909	AP15479	AP15998



### Panel T2 Retainers & Trim Panel Fasteners

AP15457	AP12759	AP15456	AP11130
AP17649	AP12565	AP13470	AP18848
AP11671	AP15970	AP12992	AP19386
AP18915	AP11797	AP18930	AP17075
AP19270	AP16695	AP15461	AP11678
AP11672	AP13461	AP10621	AP12737
AP11796	AP808	AP11863	AP2310
AP2309	AP12134	AP19682	AP18114



### Panel U1 Retaining Clips & Retainers

AP19114	AP14356	AP19729	AP20543
AP14355	AP14291	AP18297	AP14736
AP14737	AP19113	AP18842	AP17975
AP19655	AP14738	AP17004	AP14163
AP17339	AP19171	AP18877	AP18033
AP14328	AP10744	AP8853	AP14016
AP17162	AP16782	AP16784	AP11705
AP11699	AP20248	AP11706	AP18353



### Panel U2 Push-Type Retainers

AP12567	AP14011	AP14010	AP12757
AP20335	AP20869	AP20908	AP20349
AP19239	AP19118	AP20955	AP18888
AP19274	AP20247	AP20986	AP19453
AP19233	AP19246	AP20327	AP20564
AP19801	AP19639	AP17222	AP20888
AP17103	AP16622	AP13996	AP13993
AP20931	AP20458	AP19615	AP20889

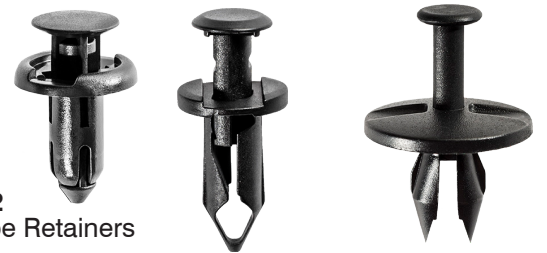

### Panel V1 Push-Type Retainers

AP18873	AP20632	AP19422	AP17216
AP13994	AP15044	AP14019	AP14020
AP15042	AP14696	AP14697	AP14260
AP17379	AP16000	AP17632	AP17267
AP14997	AP16858	AP20348	AP17439
AP14992	AP14753	AP17472	AP17057
AP19140	AP19739	AP17143	AP16835
AP18119	AP14994	AP17144	AP19613



### Panel V2 Rivets

AP13748	AP13755	AP14023	AP18108
AP13751	AP13750	AP17101	AP13752
AP13753	AP20788	AP20627	AP20834
AP16834	AP17615	AP17006	AP18461
AP20629	AP19376	AP16864	AP17121
AP17410	AP20741	AP14127	AP12652
AP17639	AP8309	AP8925	AP8931
AP5753	AP8311	AP8301	AP8313

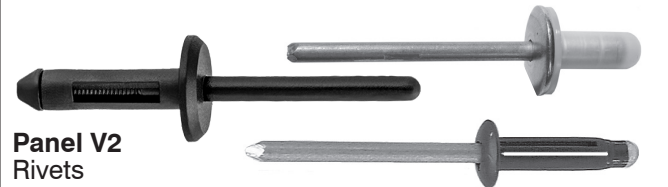

### Panel W1 Rivets, Specialty Nuts & Nylon Nuts

AP11620	AP11621	AP12655	AP12653
AP18167	AP13007	AP13009	AP13008
AP13004	AP13010	AP16253	AP16251
AP13014	AP13016	AP13017	AP13232
AP15326	AP12595	AP15335	AP18153
AP11855	AP9829	AP10330	AP11691
AP9862	AP13450	AP13960	AP13933
AP13932	AP14274	AP14313	AP3682



### Panel W2 Nylon Nuts, Screw Grommets, Thread Cutting Nuts, Push-On Retainers & Pushnut Bolt Retainers

AP11719	AP8435	AP14695	AP20954
AP19194	AP19756	AP20440	AP19721
AP14267	AP19614	AP12255	AP15711
AP3403	AP2895	AP8855	AP3404
AP2896	AP2897	AP3405	AP10733
AP2557	AP8863	AP8864	AP8865
AP8868	AP8869	AP10374	AP10086
AP10087	AP9297	AP9299	AP12127



# Auvecopak AP448 Retail Merchandiser Contents

Auvecopak part numbers are the same as standard Auveco part numbers with an "AP" prefix. Thus AP11146 is the Auvecopak version of 11146. *Photos not actual size.*

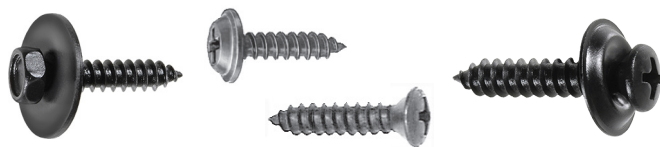

**Panel X1**  
Black Tapping Screws

AP12213	AP12214	AP12215	AP12216
AP12217	AP12218	AP12953	AP12954
AP12957	AP11788	AP11789	AP11791
AP11792	AP15774	AP13026	AP17650
AP12820	AP12060	AP18340	AP17459
AP20259	AP20455	AP16323	AP10165
AP10167	AP10181	AP10182	AP11922
AP12741	AP12742	AP15775	AP15373



**Panel X2**  
License Plate Screws, Body Bolts & Zinc/Chrome Tapping Screws

AP18354	AP16421	AP12351	AP12339
AP10823	AP9480	AP10362	AP11320
AP5711	AP11109	AP11110	AP12324
AP12693	AP12067	AP12160	AP12065
AP12066	AP11633	AP13613	AP12348
AP13614	AP10642	AP2805	AP12095
AP13708	AP15172	AP2806	AP13027
AP2710	AP1799	AP2713	AP1483



**Panel Y1**  
License Plate Screws, Zinc/Chrome Tapping Screws & Body Bolts, Bumper Bolts & Headlight Adjusting Screws

AP1717	AP2730	AP2775	AP2771
AP2751	AP2772	AP2773	AP3466
AP3467	AP17098	AP17980	AP19777
AP11369	AP9603	AP16960	AP14473
AP17315	AP17316	AP16826	AP15170
AP17034	AP12335	AP9615	AP11914
AP8443	AP9355	AP3099	AP3102
AP3178	AP11655	AP11826	AP11243



**Panel Y2**  
Moulding Clips, Clips & Fasteners and Door Hinge Pins & Bushings

AP2744	AP19626	AP2619	AP2752
AP19807	AP19378	AP9965	AP15695
AP20687	AP20390	AP20391	AP20688
AP14642	AP11152	AP19800	AP19757
AP20607	AP20774	AP20328	AP20377
AP19822	AP19821	AP8941	AP11067
AP9633	AP9639	AP9749	AP14559
AP14550	AP14553	AP16936	AP16937



**Panel Z1**  
Extruded U-Nuts, Cage Nuts, Spring Type U-Nuts, Fender & Bumper Cover Nut and Retainer

AP10048	AP15677	AP8359	AP10051
AP10053	AP8814	AP10054	AP10055
AP11625	AP11626	AP16846	AP12669
AP16842	AP16322	AP12575	AP11628
AP11629	AP11630	AP11631	AP14750
AP5586	AP5589	AP5170	AP20758
AP10064	AP10065	AP9880	AP20757
AP9879	AP10066	AP15752	AP10067



**Panel Z2**  
U-Nuts, Flat Nuts, Tubular Nuts, Cable Straps, Wire Loom Clips, Rubber Bumpers, Sheet Metal Plugs, Vacuum Caps, Shims & Miscellaneous

AP10666	AP13225	AP11292	AP5197
AP2293	AP2099	AP2103	AP1903
AP2611	AP2595	AP5195	AP10073
AP2288	AP15518	AP14298	AP20380
AP14546	AP14547	AP19440	AP20397
AP11746	AP4233	AP4188	AP4474
AP9288	AP4440	AP4439	AP2453
AP5076	AP5077	AP3155	AP3156

# AuvecoPak AP448

## Retail Merchandiser Contents

Sec. 15

### Part Number Location Chart

Auveco Pak No.	Location			Auveco Pak No.	Location		
AP808	Panel T2	Row 7	Position 2	AP8301	Panel V2	Row 8	Position 3
AP1483	Panel X2	Row 8	Position 4	AP8309	Panel V2	Row 7	Position 2
AP1717	Panel Y1	Row 1	Position 1	AP8311	Panel V2	Row 8	Position 2
AP1799	Panel X2	Row 8	Position 2	AP8313	Panel V2	Row 8	Position 4
AP1903	Panel Z2	Row 2	Position 4	AP8359	Panel Z1	Row 1	Position 3
AP2099	Panel Z2	Row 2	Position 2	AP8435	Panel W2	Row 1	Position 2
AP2103	Panel Z2	Row 2	Position 3	AP8443	Panel Y1	Row 7	Position 1
AP2288	Panel Z2	Row 4	Position 1	AP8814	Panel Z1	Row 2	Position 2
AP2293	Panel Z2	Row 2	Position 1	AP8853	Panel U1	Row 6	Position 3
AP2309	Panel T2	Row 8	Position 1	AP8855	Panel W2	Row 4	Position 3
AP2310	Panel T2	Row 7	Position 4	AP8863	Panel W2	Row 6	Position 2
AP2453	Panel Z2	Row 7	Position 4	AP8864	Panel W2	Row 6	Position 3
AP2557	Panel W2	Row 6	Position 1	AP8865	Panel W2	Row 6	Position 4
AP2595	Panel Z2	Row 3	Position 2	AP8868	Panel W2	Row 7	Position 1
AP2611	Panel Z2	Row 3	Position 1	AP8869	Panel W2	Row 7	Position 2
AP2619	Panel Y2	Row 1	Position 3	AP8925	Panel V2	Row 7	Position 3
AP2710	Panel X2	Row 8	Position 1	AP8931	Panel V2	Row 7	Position 4
AP2713	Panel X2	Row 8	Position 3	AP8941	Panel Y2	Row 6	Position 3
AP2730	Panel Y1	Row 1	Position 2	AP9288	Panel Z2	Row 7	Position 1
AP2744	Panel Y2	Row 1	Position 1	AP9297	Panel W2	Row 8	Position 2
AP2751	Panel Y1	Row 2	Position 1	AP9299	Panel W2	Row 8	Position 3
AP2752	Panel Y2	Row 1	Position 4	AP9355	Panel Y1	Row 7	Position 2
AP2771	Panel Y1	Row 1	Position 4	AP9480	Panel X2	Row 2	Position 2
AP2772	Panel Y1	Row 2	Position 2	AP9603	Panel Y1	Row 4	Position 2
AP2773	Panel Y1	Row 2	Position 3	AP9615	Panel Y1	Row 6	Position 3
AP2775	Panel Y1	Row 1	Position 3	AP9633	Panel Y2	Row 7	Position 1
AP2805	Panel X2	Row 6	Position 3	AP9639	Panel Y2	Row 7	Position 2
AP2806	Panel X2	Row 7	Position 3	AP9749	Panel Y2	Row 7	Position 3
AP2895	Panel W2	Row 4	Position 2	AP9829	Panel W1	Row 6	Position 2
AP2896	Panel W2	Row 5	Position 1	AP9862	Panel W1	Row 7	Position 1
AP2897	Panel W2	Row 5	Position 2	AP9879	Panel Z1	Row 8	Position 1
AP3099	Panel Y1	Row 7	Position 3	AP9880	Panel Z1	Row 7	Position 3
AP3102	Panel Y1	Row 7	Position 4	AP9965	Panel Y2	Row 2	Position 3
AP3155	Panel Z2	Row 8	Position 3	AP10048	Panel Z1	Row 1	Position 1
AP3156	Panel Z2	Row 8	Position 4	AP10051	Panel Z1	Row 1	Position 4
AP3178	Panel Y1	Row 8	Position 1	AP10053	Panel Z1	Row 2	Position 1
AP3403	Panel W2	Row 4	Position 1	AP10054	Panel Z1	Row 2	Position 3
AP3404	Panel W2	Row 4	Position 4	AP10055	Panel Z1	Row 2	Position 4
AP3405	Panel W2	Row 5	Position 3	AP10064	Panel Z1	Row 7	Position 1
AP3466	Panel Y1	Row 2	Position 4	AP10065	Panel Z1	Row 7	Position 2
AP3467	Panel Y1	Row 3	Position 1	AP10066	Panel Z1	Row 8	Position 2
AP3682	Panel W1	Row 8	Position 4	AP10067	Panel Z1	Row 8	Position 4
AP4188	Panel Z2	Row 6	Position 3	AP10073	Panel Z2	Row 3	Position 4
AP4233	Panel Z2	Row 6	Position 2	AP10086	Panel W2	Row 7	Position 4
AP4439	Panel Z2	Row 7	Position 3	AP10087	Panel W2	Row 8	Position 1
AP4440	Panel Z2	Row 7	Position 2	AP10165	Panel X1	Row 6	Position 4
AP4474	Panel Z2	Row 6	Position 4	AP10167	Panel X1	Row 7	Position 1
AP5076	Panel Z2	Row 8	Position 1	AP10181	Panel X1	Row 7	Position 2
AP5077	Panel Z2	Row 8	Position 2	AP10182	Panel X1	Row 7	Position 3
AP5170	Panel Z1	Row 6	Position 3	AP10330	Panel W1	Row 6	Position 3
AP5195	Panel Z2	Row 3	Position 3	AP10362	Panel X2	Row 2	Position 3
AP5197	Panel Z2	Row 1	Position 4	AP10374	Panel W2	Row 7	Position 3
AP5586	Panel Z1	Row 6	Position 1	AP10621	Panel T2	Row 6	Position 3
AP5589	Panel Z1	Row 6	Position 2	AP10642	Panel X2	Row 6	Position 2
AP5711	Panel X2	Row 3	Position 1	AP10666	Panel Z2	Row 1	Position 1
AP5753	Panel V2	Row 8	Position 1	AP10733	Panel W2	Row 5	Position 4