



**FULL-LINE PRODUCT CATALOG**

**HOLDING STRONG SINCE 1941**

**2017**

**WILTONTOOLS.COM**



# HOLDING STRONG SINCE 1941

Over 75 years ago, Wilton® designed the first Bullet-Design machinist vise and created the groundwork of quality craftsmanship from which the Wilton brand would rise. The legacy of Wilton® workmanship is the pinnacle in the industry. You can depend on the quality and durability of every tool that bears the Wilton name.



World's first bullet-design Machinist Vise is manufactured. Wilton creates a name for themselves in the market place.



Wilton expands into clamping products with new and innovative ideas.

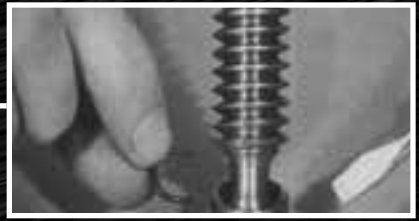

The invention of the patented replaceable Perma-Pads allows users to replace the the pad instead of the entire clamp.



For the jobs that demand function, strength and mobility, Wilton introduces the innovative ATV All-terrain Vise.



With an adjustable back gauge the Wilton® Strut Cutter allows for quick production shearing of uniform lengths.



Beat the heat, Improve your work environment and work more efficiently with the Cold Front™ 3037 Atomized Cooling Fan

## 1941      1950      1960      1970      1980      1990      2000      2017



Wilton supports war efforts in WW2 to support our us troops overseas.



Wilton is the brand of choice in the Automotive boom of the 50's.



Pow-r-arms are introduced into the Wilton product line allowing assembly-line workers hands-free production.



The new Tradesman Vise sets the new standard of quality and durability in vises.

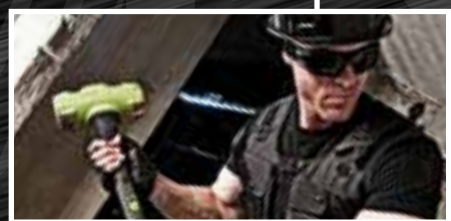

B.A.S.H® Unbreakable® Handle Sledge Hammers are introduced as the world's most durable sledge hammer.



B.A.S.H® Unbreakable® Handle Hammers expand to Grade B for railroad applications.

# WILTON®: A CONSUMER FOCUSED BRAND

# WILTON®: LIFETIME WARRANTY



## CHALLENGER VAN TOUR

With our consumers in mind, we set out on a national tour to reach as many as possible. The Challenger Van Tour launched in 2011 and has made hundreds of stops throughout industrial America.

Aboard the Challenger Van you will find an assortment of our most popular Wilton products, new products, videos, demonstrations, as well as free giveaways.

**CHECK WITH YOUR LOCAL WILTON DISTRIBUTOR TO SEE WHEN THE CHALLENGER VAN WILL BE IN YOUR AREA**



## FIND WILTON ONLINE

Find Wilton on these social media sites to get the latest product news, share your projects and connect with others.



**LIKE US ON FACEBOOK**  
[www.facebook.com/WiltonTools](http://www.facebook.com/WiltonTools)



**FOLLOW US ON TWITTER**  
[@Wilton\\_Tools](https://twitter.com/Wilton_Tools)



**CONNECT WITH US ON YOUTUBE**  
[www.youtube.com/WiltonTools](http://www.youtube.com/WiltonTools)

We are confident in every Wilton® tool we manufacture. To prove it, we back our tools and equipment that bear the Wilton® name with a Lifetime Warranty. This includes everything from Vises to Clamps, Pipe Wrenches and B.A.S.H® Hammers. We hope you are as proud and confident of our equipment as we are.

The Wilton® lifetime warranty is for the product's lifetime with no end date. This warranty covers manufacturer's defect only and does not cover misuse, abuse, accidents, negligence, wear and tear, improper repair or alterations, etc. For more information please visit [wiltontools.com](http://wiltontools.com)

\*\* Wilton Strut Cutters and and Cold Front™ Atomized Cooling Fan include a standard One Year warranty



# NEW PRODUCTS



## TRADESMAN<sup>®</sup> XC VISES

Combat Extreme Conditions with innovative electroless nickel coating on the Tradesman XC vises.

**SEE PAGE 14**

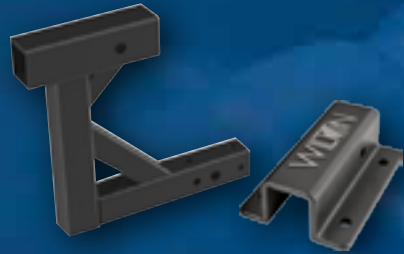

## ATV<sup>®</sup> ACCESSORIES

The ATV vise has added another new accessory to the line to elevate the vise from your hitch to a new work height.

**SEE PAGE 35**



## STRUT CUTTER

An innovative portable hydraulic tool designed to cut strut products cleanly and efficiently with no waste, no mess and no de-burring.

**SEE PAGE 42**



## COLD FRONT<sup>™</sup> 3037 ATOMIZING FAN

When temperature rises, so do on-the-job risks, damaged productivity and serious injury. Now beat the heat with for good with the Cold Front<sup>™</sup> Atomized Cooling Fan.

**SEE PAGE 44**



## B.A.S.H.<sup>®</sup> GRADE B SLEDGE HAMMERS & SPIKE MAUL

BASH Grade B Hammers and Spike Maul are designed In-Line with Arema Standards and use harder alloy and deep heat treatment permitting heads to be redressed.

**SEE PAGE 76**

# TABLE OF CONTENTS

## VISES

USA Bullet Bench Vises .....	8-17
Industrial Bench Vises.....	18-29
Pow-R-Arms .....	30-31
Truck Hitch Vise .....	32-35
Machine Vises.....	36-41

## STRUT CUTTER

Strut Cutter .....	42-43
--------------------	-------

## COOLING FAN

Cold Front <sup>™</sup> 3037 .....	44-45
------------------------------------	-------

## CLAMPS

F-Clamps.....	46-55
C-Clamps .....	56-67
Specialty Clamps .....	68-69

## HAND TOOLS

B.A.S.H. <sup>®</sup> Unbreakable Handle Striking Tools.....	70-82
Pipe Wrenches .....	83





# BULLET VISES

MADE IN AMERICA. MADE TO LAST.

The Wilton® Bullet Vise family has improved over the years, but has always maintained the same high quality and integrity since 1941. This trademarked design has proven it's superiority for over 75 years. Bullet vises are proudly built in the USA.



**THE BULLET  
ADVANTAGE**



**WILTON COMBO  
PIPE AND BENCH**



**WILTON  
MACHINIST**



**WILTON  
TRADESMAN XC**



**WILTON  
TRADESMAN**

# BULLET VISES

THE BULLET ADVANTAGE

MADE IN  
USA

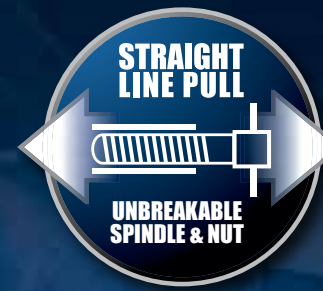
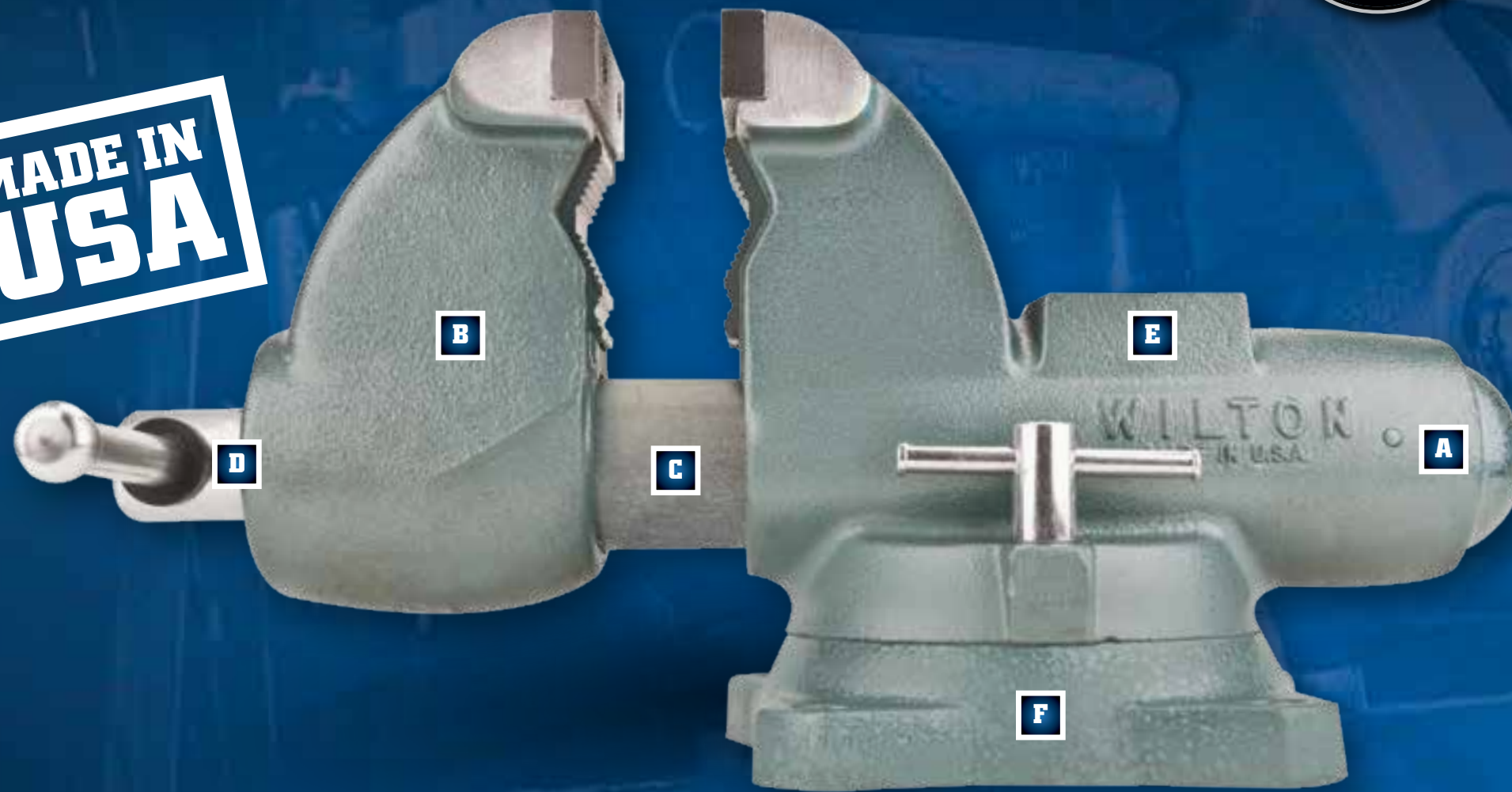

## DURABILITY

### A FULLY ENCLOSED DESIGN:

Extends the life of the vise by protecting all internal components and keeping out dust and debris. Lifetime lubricated and permanently sealed for trouble free service.

### B 60,000 PSI DUCTILE IRON BODY:

Virtually indestructible with 2X the strength of grey casted vises.

### C PRECISION SLIDE BAR

Keyed for a .003" fit, eliminating movement in the front jaw regardless of opened distance

## FUNCTIONALITY

### D LONGER SPINDLE NUT:

3X longer and 2X thicker, ensures a lifetime of smooth spindle movement and straight-line pull.

### E LARGER ANVIL

2X larger than the average anvil. Designed to take a beating while forming and shaping materials.

### F 4 BOLT MOUNTING PATTERN:

4 bolt pattern sturdier than industry-average 3 bolt pattern, maximizing stability during use.

## THE WILTON® BULLET DESIGN



FULLY ENCLOSED DESIGN



60,000 PSI DUCTILE IRON BODY



PRECISION SLIDE BAR



LONGER SPINDLE NUT



LARGER ANVIL



4 BOLT MOUNTING PATTERN

# WILTON® COMBO PIPE & BENCH

WILTON'S WORKHORSE

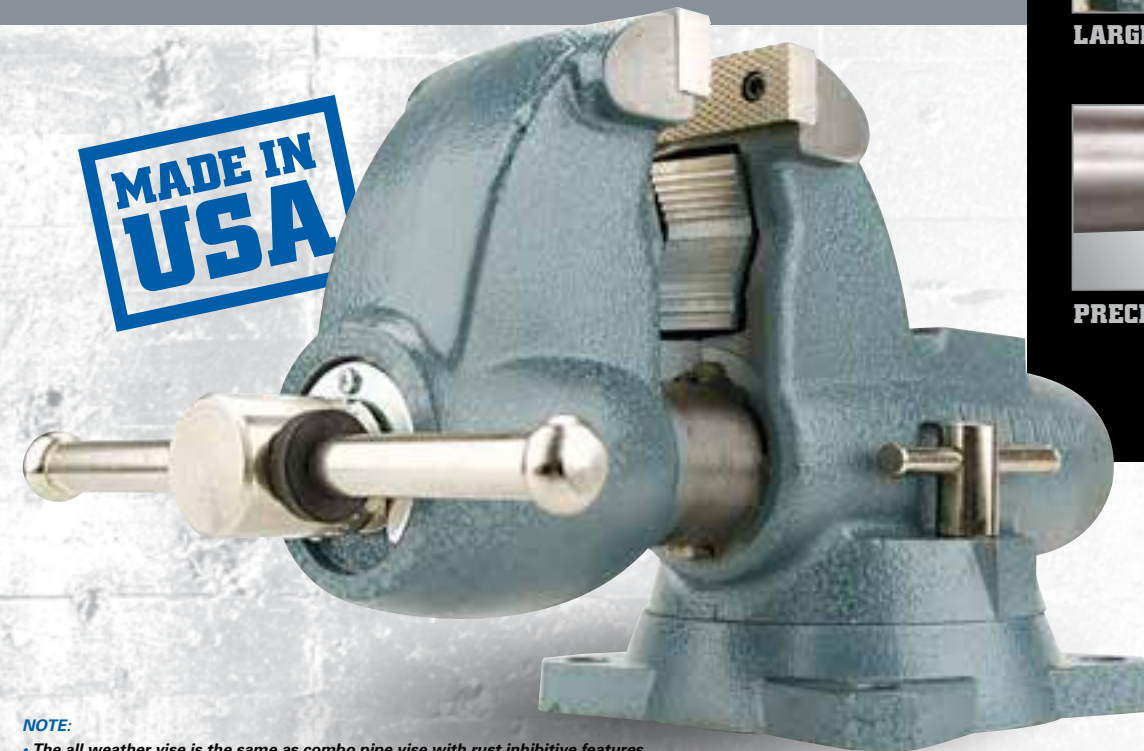

**NOTE:**  
 • The all weather vise is the same as combo pipe vise with rust inhibitive features.  
 • Meets federal spec # GGG-V-410a, Type IV.



SEALED CONSTRUCTION



LARGE ANVIL



PRECISION SLIDE BAR



## FEATURES

### SELF CENTERING PIPE JAWS:

- Hold up to 6" pipe safely and securely
- Great for irregularly shaped objects

### DEEP THROAT STYLE:

- Up to 50% added depth to meet tough job requirements requiring large capacity

## IDEAL FOR

- Plant Maintenance
- Oil Field Service
- Heavy Construction
- Mechanical Trades
- Steel Fabrication

Stock No.	Model	Jaw Width (in.)	Maximum Opening (in.)	Throat Depth (in.)	Pipe Jaw Capacity (in.)	Net Weight (lbs.)
<b>COMBO PIPE AND BENCH – SWIVEL BASE</b>						
10200	C-0	3-1/2	5	4-1/2	1/8 – 2 1/2	51
10225	C-1	4-1/2	6	4-3/4	1/8 – 3 1/2	78
10250	C-2	5	7	5-5/16	1/8 – 4 1/2	100
10275	C-3	6	9	6-5/8	1/4 – 6	204
<b>ALL WEATHER COMBO PIPE AND BENCH – SWIVEL BASE</b>						
10400	AW35	3-1/2	5	4-1/2	1/8 – 2 1/2	51
10500	AW45	4-1/2	6	4-3/4	1/8 – 3 1/2	79

Stock No.	Replacement Jaw Insert Set No.	Replacement Pipe Jaw Insert Set No.
10200	2904960	2908050
10225	2905000	2900770
10250	2903240	2900830
10275	2907370	2907600
10400	2905040	2901100
10500	2907430	2907420

# WILTON® MACHINIST

WILTON'S ORIGINAL VISE

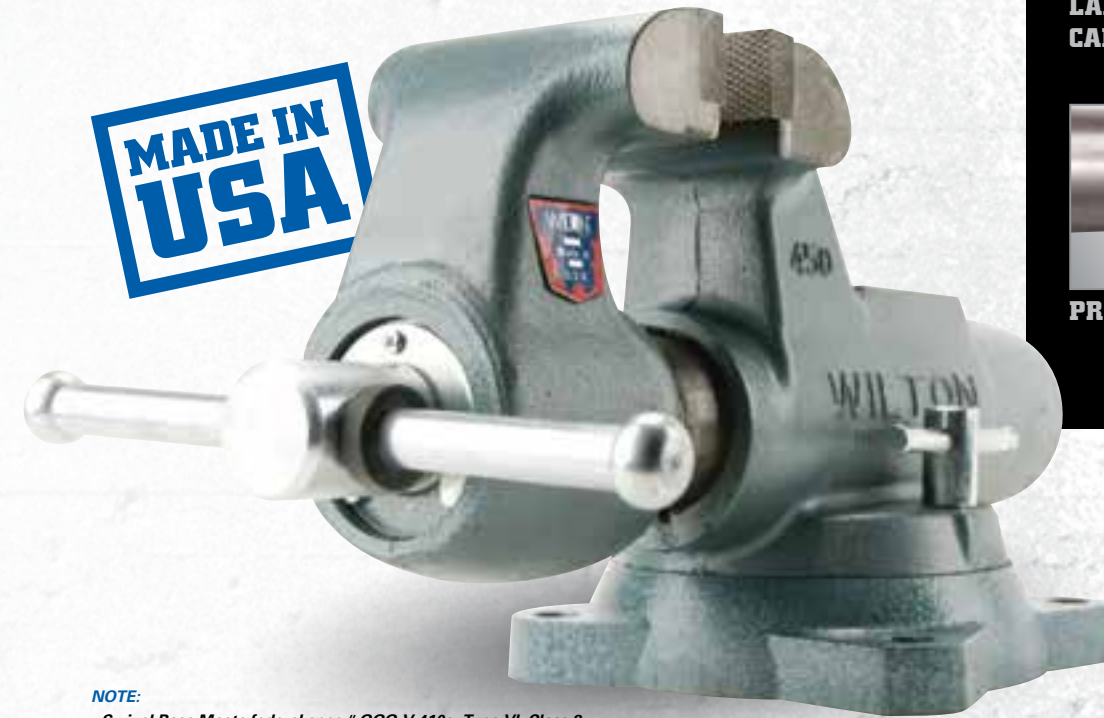

**NOTE:**  
 • Swivel Base Meets federal spec # GGG-V-410a, Type VI, Class 2  
 • Stationary Base Meets federal spec # GGG-V-410a, Type VI, Class 1



SEALED CONSTRUCTION



LARGEST WORKING CAPACITY



PRECISION SLIDE BAR



## FEATURES

### STATIONARY / 360° SWIVEL BASE:

- All sizes available in both stationary and swivel base

### MAX JAW CAPACITY:

- Up to 12" jaw opening for jobs demanding maximum holding capacity

### LARGE ANVIL:

- Designed to take a pounding while forming and shaping materials

## IDEAL FOR

- Machine Shops
- Automotive Maintenance
- Maintenance and Repair
- Metal Fabrication

Stock No.	Model	Jaw Width (in.)	Jaw Opening (in.)	Throat Depth (in.)	Replacement Jaw Insert Set No.	Net Weight (lbs.)
<b>MACHINIST – SWIVEL BASE</b>						
10006	300S	3	4-3/4	2-5/8	2903080	30
10011	350S	3-1/2	5-1/4	2-3/4	2904960	44
10016	400S	4	6-1/2	3-1/2	2904980	62
10021	450S	4-1/2	7-1/2	4	2905000	71
10026	500S	5	8	4-1/4	2905020	96
10031	600S	6	10	5-1/2	2903280	156
10036	800S	8	12	5-13/16	2904940	238
<b>MACHINIST – STATIONARY BASE</b>						
10056	300N	3	4-3/4	2-5/8	2903080	25
10066	350N	3-1/2	5-1/4	2-3/4	2904960	35
10076	400N	4	6-1/2	3-1/2	2904980	54
10086	450N	4-1/2	7-1/2	4	2905000	63
10096	500N	5	8	4-1/4	2905020	88
10107	600N	6	10	5-1/2	2903280	143
10116	800N	8	12	5-13/16	2904940	218

# WILTON® TRADESMAN XC VISES

FOR EXTREME CONDITIONS



**MADE IN  
USA**



SEALED CONSTRUCTION



PRECISION SLIDE BAR



LARGE HEAVY-DUTY  
ANVIL



## FEATURES

### JAW INSERTS

- Coated Jaw Inserts prevent corrosion and allow the jaws to be replaced with ease

### PIPE JAWS

- Coated Pipe Jaws prevent corrosion and allow pipe jaws to be used with ease

### SEALED SPINDLE

- Sealed and Coated Spindle retains lubrication and prevents accumulation of debris inside the vise nut. The electroless nickel coating protects the spindle from corrosion permitting extended use in harsh environments

### BODY & SLIDE BAR

- Coated Movable Jaw and Slide Bar ensures the mobility of all moving parts when used in harsh outdoor environments

### OVERSIZED HANDLE

- Oversized Handle ensures easy opening and closing of the vise. The electroless nickel coating protects the handle from corrosion in harsh environments

## IDEAL FOR

- Utility Work Trucks
- Extreme Environments
- Construction Sites
- Automotive

Stock No.	Model	Jaw Width (in.)	Jaw Opening (in.)	Throat Depth (in.)	Pipe Jaw Capacity (in.)	Net Weight (lbs.)
TRADESMAN – SWIVEL BASE						
28801	1765XC	6-1/2	6-1/2	4	1/4 - 3-1/2	71
28802	1780XC	8	7	4-3/4	1/8 - 3-1/2	111

Stock No.	Replacement Jaw Insert Set No.	Replacement Pipe Jaw Insert Set No.
28801	2908080XC	2904200XC
28802	2908100XC	2908050XC

## COATED COMPONENT FEATURES

- A** JAW INSERTS
- B** PIPE JAWS
- C** SPINDLE AND CASING NUT
- D** BODY & SLIDE BAR
- E** OVERSIZED HANDLE

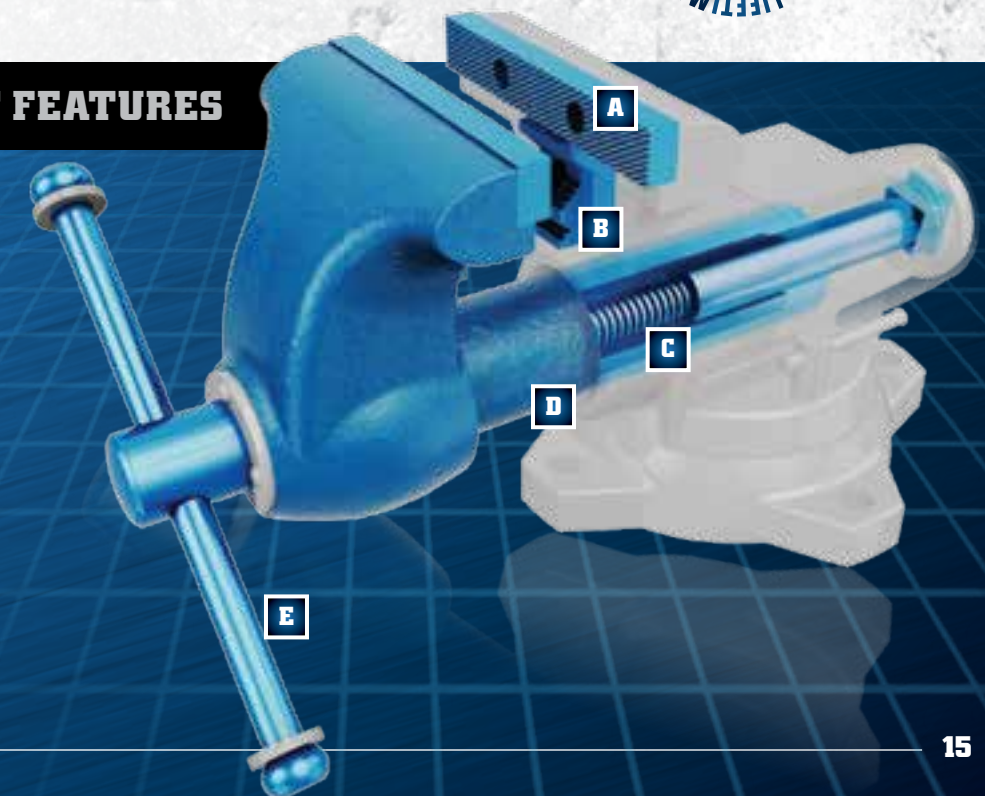



# WILTON® TRADESMAN

#1 INDUSTRIAL BENCH VISE IN THE USA

**MADE IN  
USA**

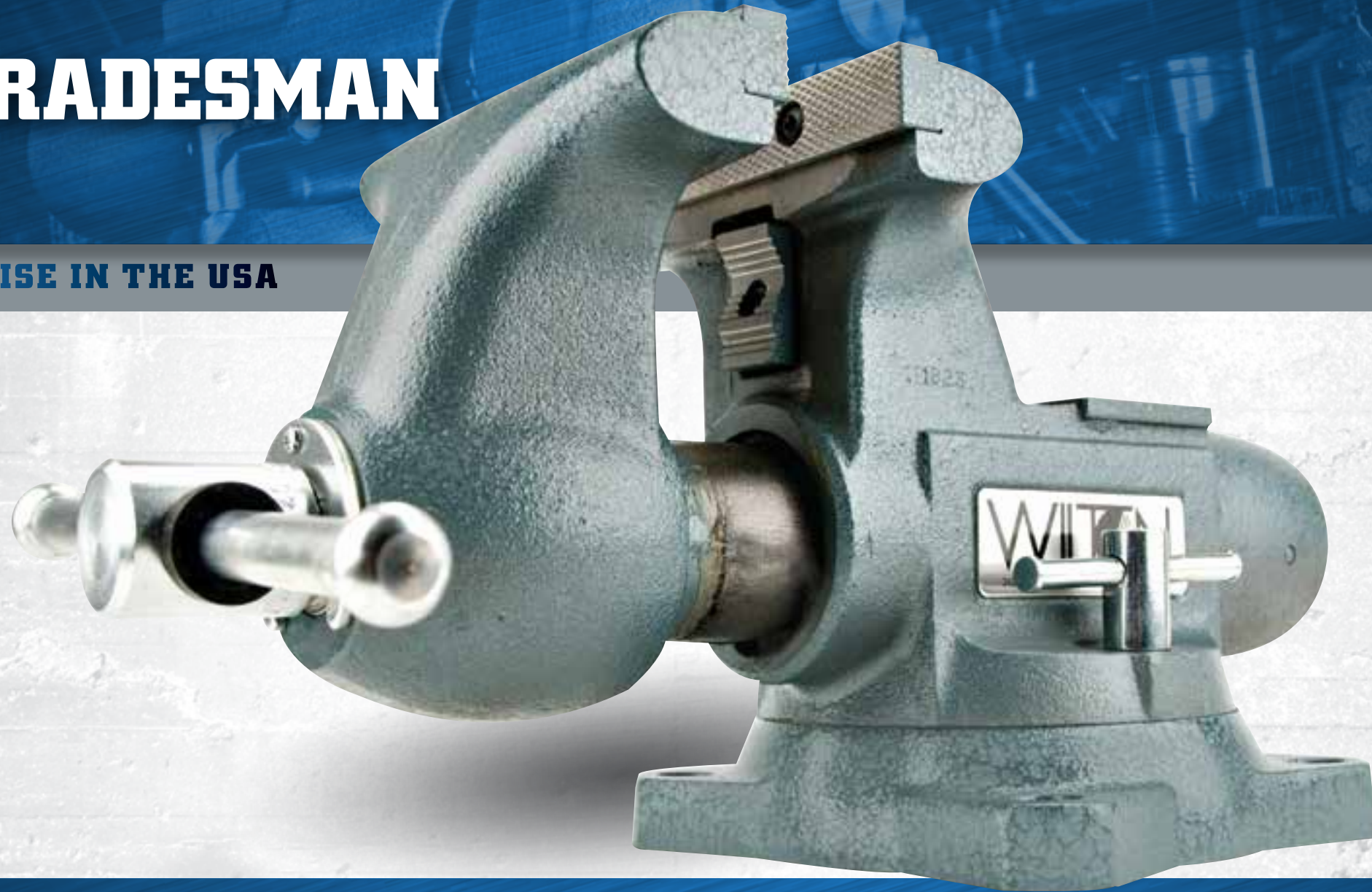

SEALED CONSTRUCTION



LARGE ANVIL



PRECISION SLIDE BAR



## FEATURES

### STEEL PIPE JAWS:

- Fixed jaws hold up to 3-1/2" pipe safely and securely
- Great for irregularly shaped objects

### MAX JAW CAPACITY:

- Up to 7" jaw opening for jobs demanding maximum holding capacity

### REVERSIBLE JAW INSERTS:

- Standard serrated jaws for extra grip or smooth to prevent marring on softer surfaces

## IDEAL FOR

- Tradesmen
- Metal Fabrication
- Automotive
- Service and MRO
- Construction Sites
- Utility

Stock No.	Model	Jaw Width (in.)	Jaw Opening (in.)	Throat Depth (in.)	Pipe Jaw Capacity (in.)	Net Weight (lbs.)
<b>TRADESMAN – SWIVEL BASE</b>						
63199	1745	4-1/2	4	3-1/4	1/4 – 2-1/2	42
63200	1755	5-1/2	5	3-3/4	1/4 – 3	52
63201	1765	6-1/2	6-1/2	4	1/4 – 3-1/2	71
63202	1780A	8	7	4-3/4	1/8 – 3-1/2	111

Stock No.	Replacement Jaw Insert Set No.	Replacement Pipe Jaw Insert Set No.
63199	2908060	2904200
63200	2908070	2904200
63201	2908080	2904200
63202	2908100	2908050

## PEDESTAL BASE

### BASE:

- 18" x 18" x 1/4", Top: 10-1/2" x 8-1/2" x 1/4"
- Great for irregularly shaped objects

### PERFECT FOR:

- 1755 and 1765 Tradesman Swivel base models

Stock No.	Model	Description	Ship Wt. (Lbs.)
<b>TRADESMAN PEDESTAL BASE</b>			
63185	159V	Steel Pedestal Base Fits Models 1755 and 1765 (33-1/2" Tall Base)	55



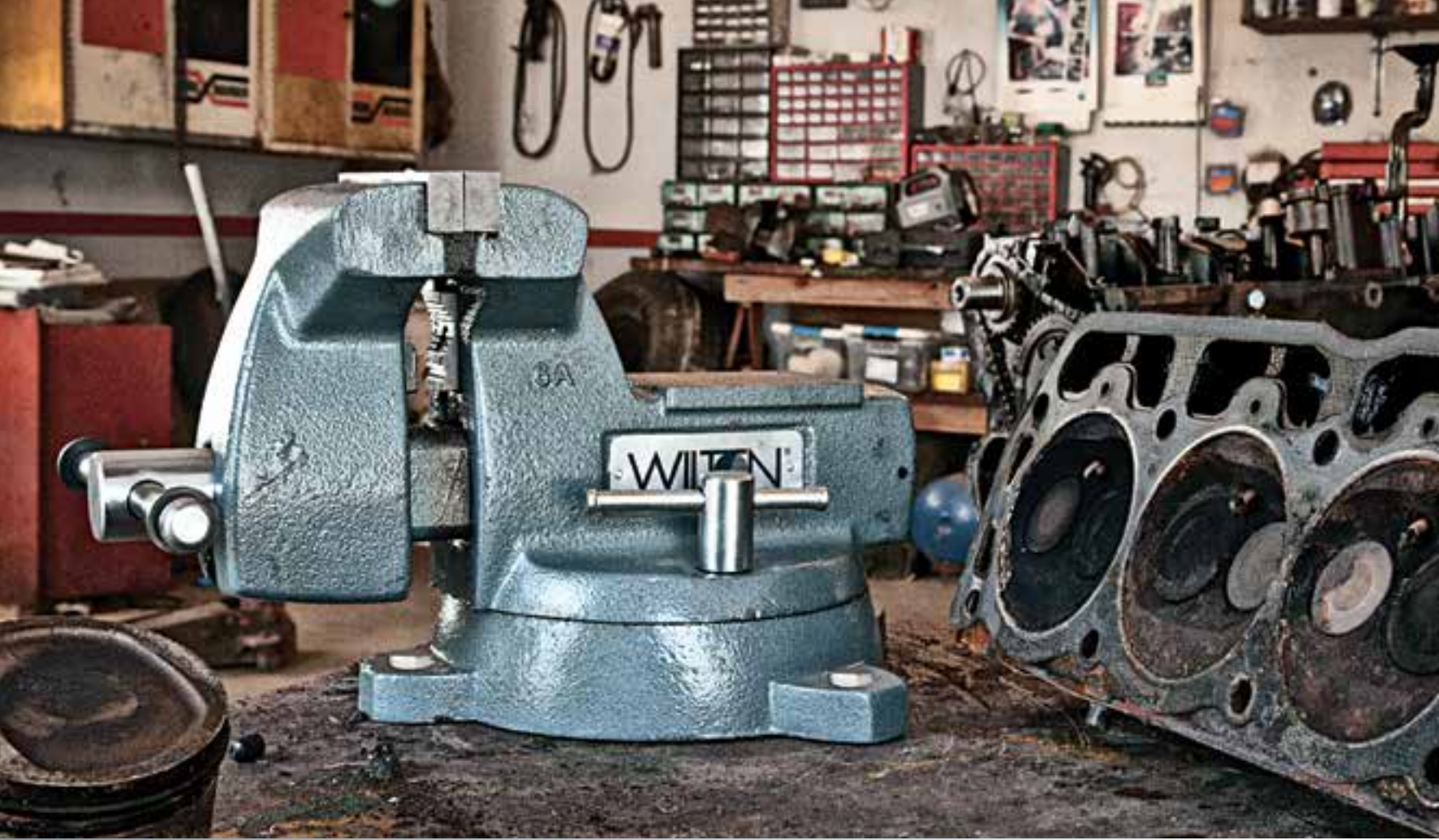

# INDUSTRIAL BENCH VISES

Wilton's expansive Industrial Bench Vise line ensures we have you covered in any industrial setting.



**VERSATILE AND DEPENDABLE**



**MECHANICS**

**UTILITY**

**MULTI-PURPOSE**

**SPECIALTY**

**REVERSIBLE**

**SHOP**

**SUPER JUNIORS**

**JAW CAPS**

# WILTON® MECHANICS

**BUILT FOR SERIOUS MECHANICS**



**HARDENED STEEL JAWS  
PIPE JAWS**



**SEALED CONSTRUCTION**



**4 MOUNTING POSTS**



# WILTON® REVERSIBLE MECHANICS

**VERSATILITY. REVERSABILITY**

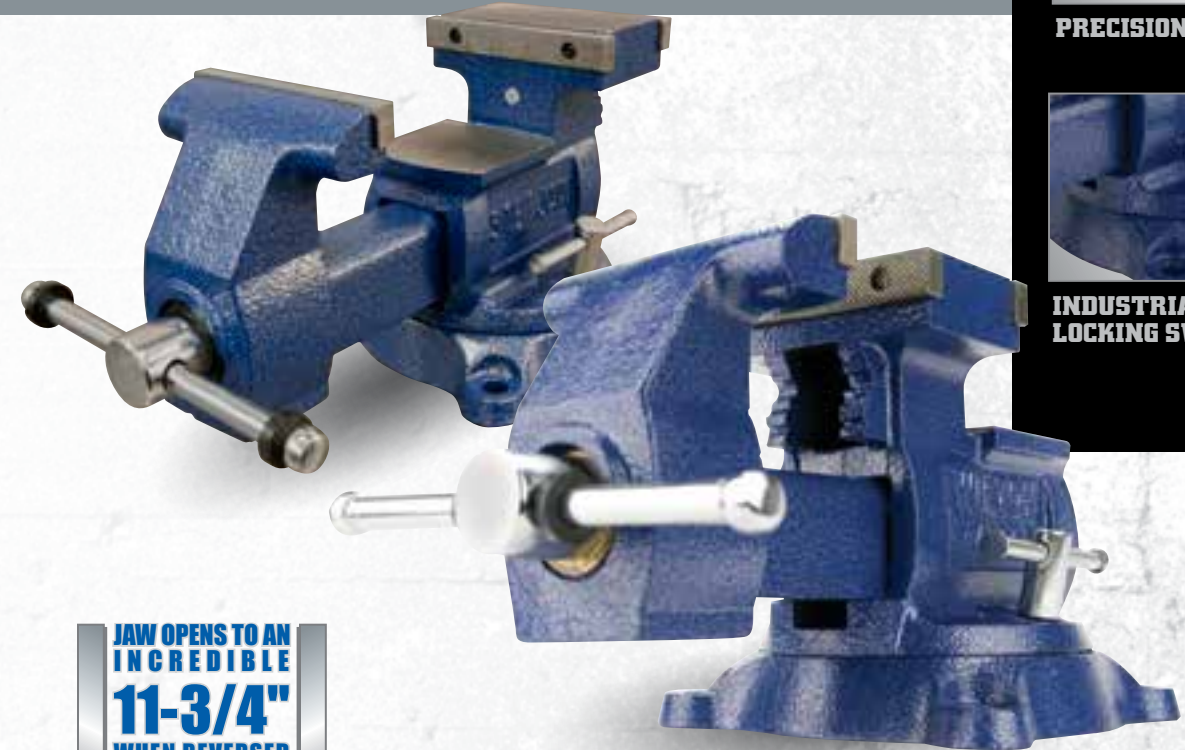

**HARDENED STEEL JAWS**



**PRECISION SLIDE HANDLE**



**INDUSTRIAL 360°  
LOCKING SWIVEL BASE**



**JAW OPENS TO AN  
INCREDIBLE  
11-3/4"  
WHEN REVERSED**

## FEATURES

### 30,000 PSI IRON BODY:

- Heavy-Duty castings are built for rugged use and extended life

### LIFETIME LUBRICATION:

- Grease is permanently sealed in for trouble-free service

### HI-VISIBILITY YELLOW:

- Conforms to OSHA standards for Physical Hazards Regulation #1910.144

## IDEAL FOR

- Professional Mechanics
- Automotive Maintenance
- Maintenance and Repair

Stock No.	Model	Jaw Width (in.)	Maximum Opening (in.)	Throat Depth (in.)	Pipe Jaw Capacity (in.)	Weight (lbs.)
<b>740 SERIES MECHANICS VISES</b>						
21300	744	4	4-1/2	3-7/16	1/4 – 2	37
21400	745	5	5-1/4	3-3/4	1/4 – 2-1/2	46
21500	746	6	5-3/4	4-1/8	1/4 – 3-1/2	63
21800	748A	8	8-1/4	4-3/4	1/4 – 3-1/2	81
<b>HIGH-VISIBILITY SAFETY VISES</b>						
63187	1550	5	5-1/4	3-3/4	1/4 – 2-1/2	46
63188	1560	6	5-3/4	4-1/8	1/4 – 3-1/2	63

Stock No.	Replacement Jaw Insert Set No.	Replacement Pipe Jaw Insert Set No.
21300	21300-03	21300-03
21400	2904110	2904110
21500	21500-03	21500-03
21800	21800-03	21800-03
63187	21400-03	21400-03
63188	21500-03	21500-03

## FEATURES

### 30,000 PSI IRON BODY:

- Heavy-Duty castings are built for rugged use and extended life

### PIPE JAWS:

- Built-In Steel Jaws Handle Pipe From 1/8" – 3"

### DUAL ANVILS:

- Two working anvil surfaces for forming and shaping materials

### HARDENED STEEL JAWS:

- Furnished with a serrated pattern to insure strength and long life

## IDEAL FOR

- Professional Mechanics
- Automotive Maintenance
- Maintenance and Repair

Stock No.	Model	Jaw Width (in.)	Maximum Opening Reversed (in.)	Throat Depth Reversed (in.)	Pipe Jaw Capacity (in.)	Replacement Jaw Insert No.	Net Weight (lbs.)
<b>REVERSIBLE MECHANICS VISE – SWIVEL BASE</b>							
14500	4500	5-1/2	6 / 9-3/4	3-3/4 / 2-3/4	1/4 – 2	14500S41	46
14600	4600	6-1/2	8 / 9-3/4	4 / 3	1/8 – 3-1/2	14600S03	52
14800	4800	8	9-1/2 / 11-3/4	5 / 2-3/4	1/8 – 4-1/2	14800S03	77

# WILTON® UTILITY

IDEAL FOR ANY JOB

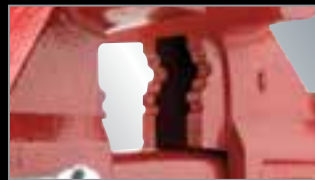
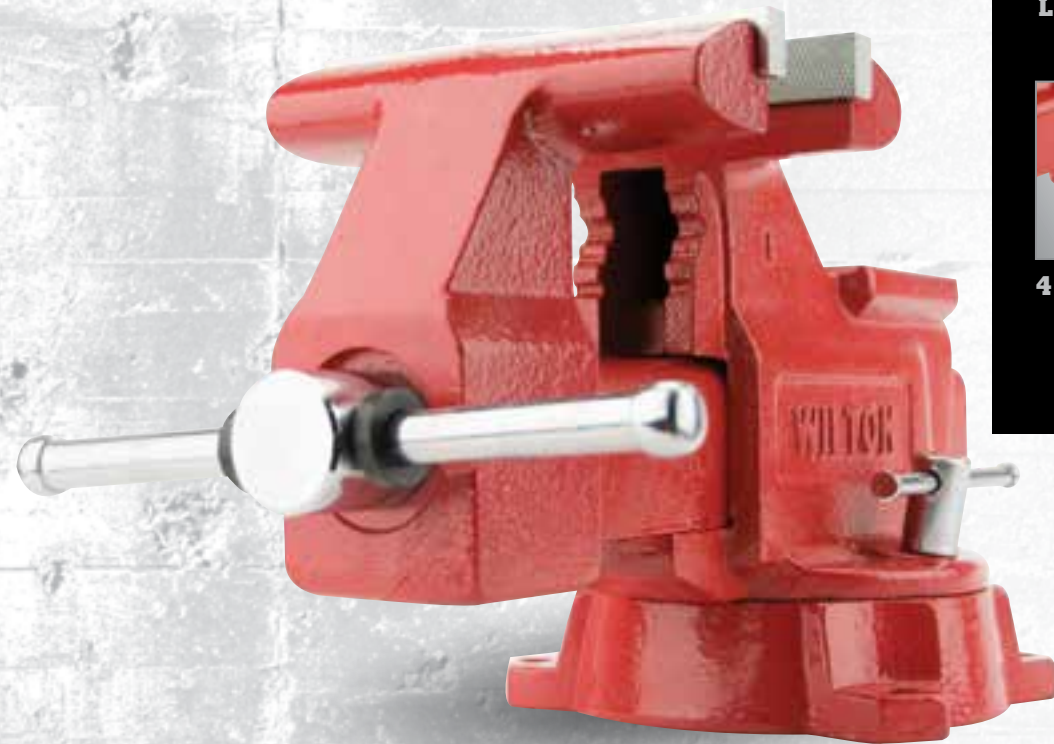

PIPE JAWS



LARGE ANVIL



4 MOUNTING POSTS



# WILTON® SHOP

BUILT FOR YOUR WORKBENCH



PIPE JAWS



POLISHED ANVIL



4 MOUNTING POSTS



## FEATURES

### REPLACEABLE STEEL JAWS:

- Furnished with a serrated pattern to insure strength and long life

### LARGE ANVIL:

- Designed to take a pounding while forming and shaping materials

### 180° LOCKING SWIVEL BASE:

- Single lockdown provides quick and easy positioning

Stock No.	Model	Jaw Width (in.)	Maximum Opening (in.)	Throat Depth (in.)	Pipe Jaw Capacity (in.)	Replacement Jaw Insert No.	Net Weight (lbs.)
<b>UTILITY VISES – SWIVEL BASE</b>							
11126	674	4-1/2	4	2-5/8	1/8 – 2	76654S41	19
11127	675	5-1/2	5	3-1/4	1/8 – 2-1/2	11127S41	27
11128	676	6-1/2	5-1/2	3-13/16	1/8 – 2-1/2	11128S41	38
191	656HD	6-1/4	6	4-3/8	1/8 – 3	11106S41	58
11800	648HD	8	7-1/2	4-1/2	1/8 – 3	2904130	77

## IDEAL FOR

- General Purpose
- Light Tradesman
- Utility and Service
- Automotive

## FEATURES

### HARDENED STEEL JAWS:

- Furnished with a serrated pattern to insure strength and long life

### DOUBLE LOCK DOWNS:

- 2 Lockdowns for a sturdier base and less rotation

### 360° LOCKING SWIVEL BASE:

- 360° swivel ability for ideal positioning on workbench

## IDEAL FOR

- General Purpose
- Light Tradesman
- Utility and Service
- Automotive

Stock No.	Model	Jaw Width (in.)	Maximum Opening (in.)	Throat Depth (in.)	Pipe Jaw Capacity (in.)	Replacement Jaw Insert No.	Net Weight (lbs.)
<b>SHOP VISES – SWIVEL BASE</b>							
63300	WS4	4	4	2-3/4	5/8" - 2"	310041W	20
63301	WS5	5	5	3	5/8" - 2 3/8"	310051W	28
63302	WS6	6	6	3-1/2	5/8" - 2 1/2"	310061W	42
63304	WS8	8	8	4	3/4" - 3"	310081W	65

# WILTON® MULTI-PURPOSE

360° JAW ROTATION

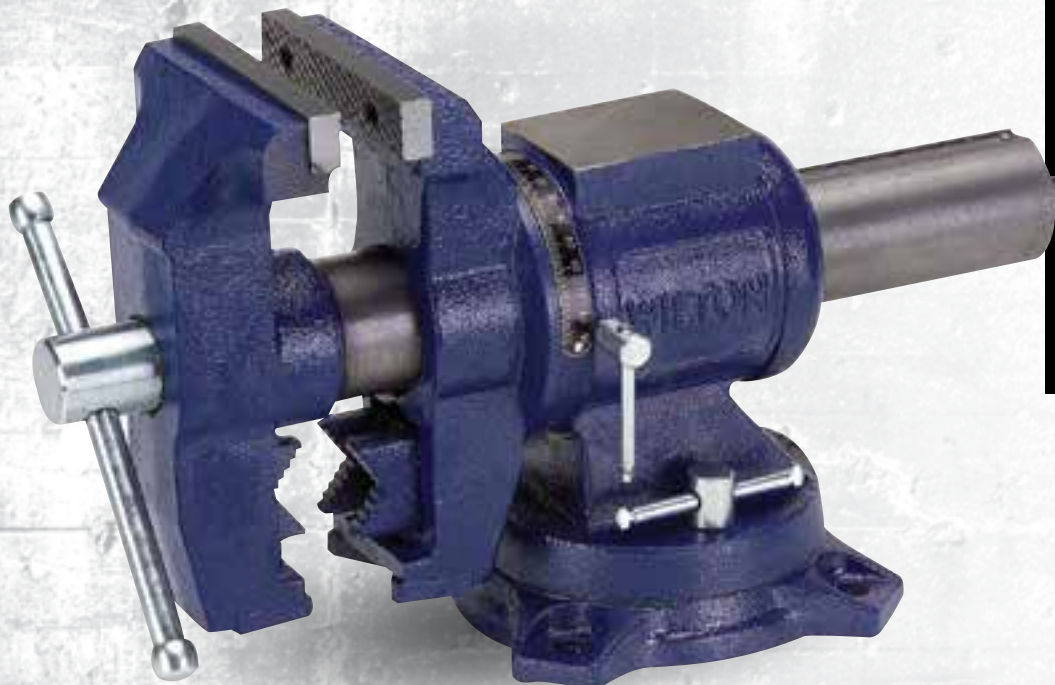

360° JAW ROTATION

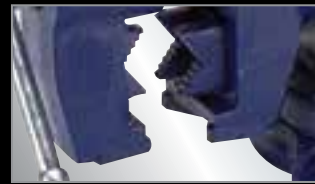

PERMANENT PIPE JAWS



LARGE ANVIL



## FEATURES

- ROTATING HEAD:**
  - Great for clamping material at any angle
- V-JAW:**
  - Holds 1" - 3" diameter round stock vertically
- INDEXING:**
  - 90° left and right for quick setup
- LARGE ANVIL:**
  - Built-in anvil for flat shaping

## IDEAL FOR

- General Purpose
- Light Tradesman
- Utility and MRO

Stock No.	Model	Jaw Width (in.)	Maximum Opening (in.)	Throat Depth (in.)	Pipe Jaw Capacity (in.)	Replacement Jaw Insert No.	Net Weight (lbs.)
<b>MULTI-PURPOSE VISES – SWIVEL BASE</b>							
69999	-	5	5-1/4	3	3/8-3	69999S41	42

# WILTON® GENERAL PURPOSE

WEEKEND WARRIOR

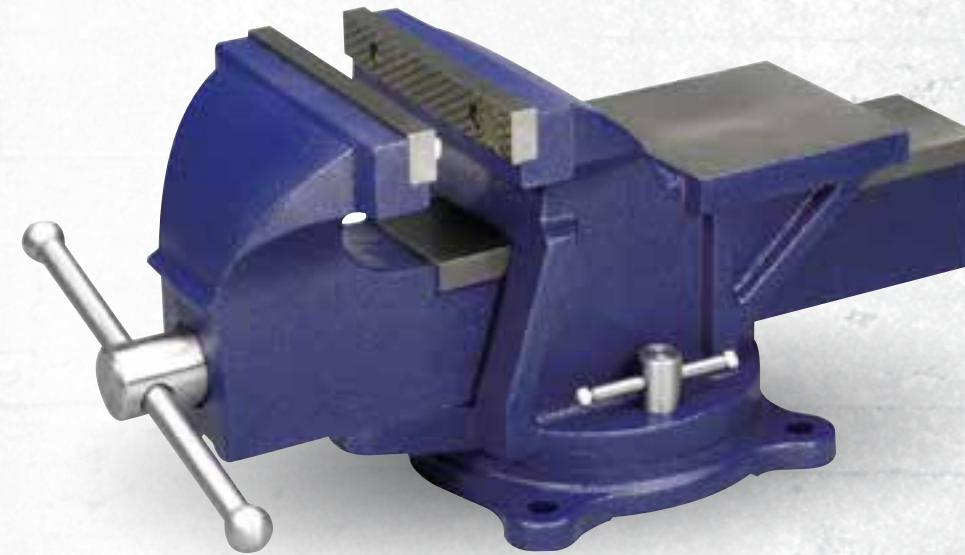

HIGH STRENGTH STEEL CONSTRUCTION

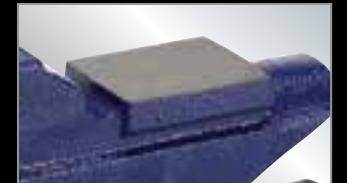

BUILT-IN ANVIL



DIAMOND SERRATED JAW FACES



## FEATURES

- WISE BODY:**
  - Made from high strength steel
- JAW FACES:**
  - Diamond serrated for positive gripping
- BASE:**
  - Swivel base with double lock down
- ANVIL:**
  - Built-in anvil for flat shaping

## IDEAL FOR

- Light Duty Use
- General Purpose
- Home Shop
- Weekend Projects

Stock No.	Model	Jaw Width (in.)	Maximum Opening (in.)	Throat Depth (in.)	Pipe Jaw Capacity (in.)	Net Weight (lbs.)
<b>GENERAL PURPOSE</b>						
11104	-	4	4	2-1/4	-	16
11105	-	5	5	2-1/2	-	27
11106	-	6	6	3	-	39

# WILTON® SUPER JUNIORS

## THE MINI BULLET



CLAMP-ON  
BASE

SWIVEL BASE

NOTE:  
• Clamp-On has 3" opening



BROAD ANVIL



LIGHTWEIGHT AND  
PORTABLE



FULLY ENCLOSED DESIGN



# WILTON® CLAMP-ON & VACUUM

## FOR SMALLER PROJECTS

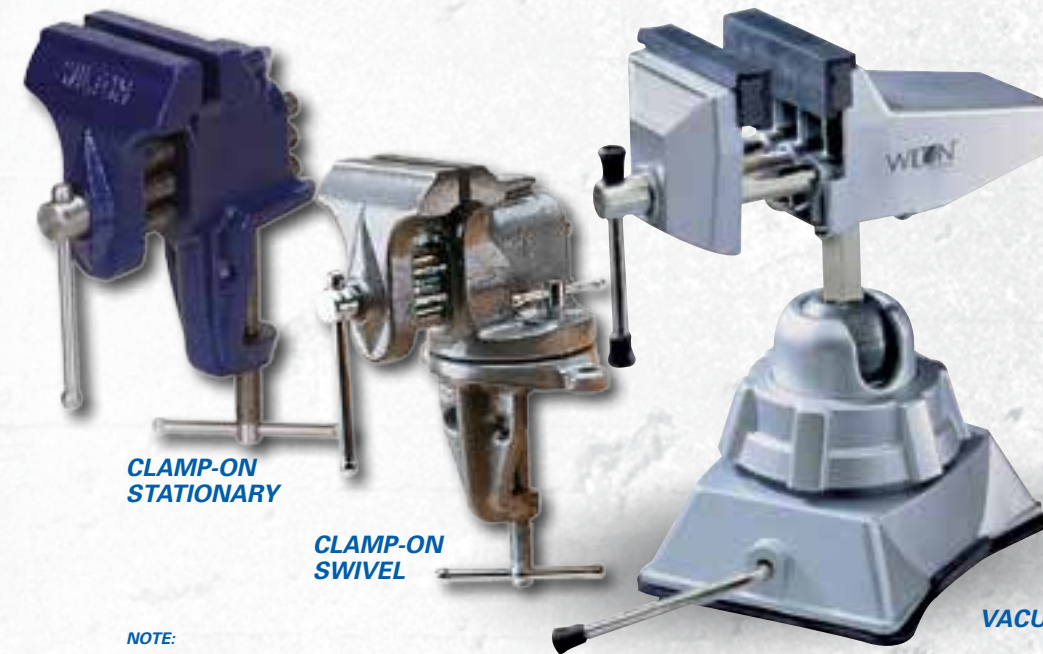

CLAMP-ON  
STATIONARY

CLAMP-ON  
SWIVEL

VACUUM

NOTE:  
• Clamp-On Meets federal spec #GGG-V-410a



DOUBLE STEEL  
GUIDE BARS



CAST JAWS



VACUUM BASE



## FEATURES

### STEEL TOP JAWS:

- Replaceable and grooved for strong holding action

### 45° LOCKING SWIVEL BASE:

- Double lockdowns for quick and easy positioning in any working position

## IDEAL FOR

- General Purpose
- Light Tradesman
- Home Shop

Stock No.	Model	Jaw Width (in.)	Jaw Opening (in.)	Throat Depth (in.)	Replacement Jaw Insert No.	Net Weight (lbs.)
<b>WILTON® SUPER-JUNIOR® – CLAMP-ON BASE</b>						
63198	CBV-65	2-1/2	2-1/8	1-3/4	2900270	11
63247	CBV-100	4	2-1/4	2	2900300	18
<b>WILTON® SUPER-JUNIOR® – SWIVEL BASE</b>						
63244	SBV-65	2-1/2	2-1/8	1-3/4	2900270	9
63248	SBV-100	4	2-1/4	2	2900300	14

## FEATURES - Clamp-On

### DOUBLE STEEL GUIDE BARS:

- Insures parallel alignment of pipe jaws for consistent holding pressure

### CAST JAWS:

- Holds workpiece firmly

### PORTABLE:

- Vice can quickly and easily be transferred to new work station

## IDEAL FOR

- General Purpose
- Light Tradesman
- Woodworking

## FEATURES - Vacuum

### 360° SWIVEL BASE AND 180° HEAD TILT:

- Can be used in a wide variety of working positions

### SEAL VACUUM BASE:

- Secure base to any flat, clean and dry surface by pressing base to surface and pulling lock arm

### CAST ALUMINUM BODY:

- Strong and durable

Stock No.	Model	Jaw Width (in.)	Maximum Opening (in.)	Net Weight (lbs.)
<b>WILTON® CLAMP-ON VISE – STATIONARY BASE</b>				
33150	150	3	2-1/2	4
<b>WILTON® CLAMP-ON VISE – SWIVEL BASE</b>				
33153	153	3	2-1/2	6
<b>WILTON® VACUUM VISE</b>				
63500	3VB	2-3/4	2-1/2	3

# WILTON® WOODWORKING

WOODWORKING MADE TOUGH



Replaceable Magnetic Maple Jaw Inserts

LIGHT-DUTY WOODWORKING



SELF CENTERING JAW



REPLACEABLE MAPLE JAW INSERTS



STURDY STEEL HANDLE

# BENCH VISE ACCESSORIES



## MODEL P-PRISM MAGNEFIX JAW CAPS

- Aluminum alloy with synthetic rubber cover
- Jaw construction includes a 120° horizontal V-groove, three vertical V-grooves and a 90° groove for marking out and center punching
- Ideal for light tapping and thread cutting

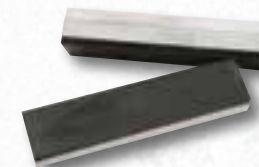

## MODEL A-ALUMINUM MAGNEFIX JAW CAPS

- Aluminum alloy design includes six grooves to compensate for the unevenness of the workpiece
- Deeper V-groove ensures more secure clamping of circular workpieces
- Use together with rubber magnefix jaw caps



## MODEL F-FIBER FACE MAGNEFIX JAW CAPS

- Aluminum alloy with laminated fiber cover to prevent the absorption of outside materials
- Heat parts rapidly by concentrating heat into part
- Use on workpieces to avoid distortion and clamping marks



## MODEL R-RUBBER FACE MAGNEFIX JAW CAPS

- Aluminum alloy with synthetic rubber cover
- Jaw cap conforms to workpiece and grips firmly without slipping while protecting work surface
- Use in combination with aluminum and prism jaw caps to clamp taper pins or tapered workpieces

## COPPER JAW CAPS

- Designed to avoid marring the surface of materials
- 100% copper jaw caps have polished faces and pliable copper extensions for a sure-grip fit

## MULTI-GRIP VISE JAWS

- Soft polyurethane jaws designed to avoid marring the surface of softer metals and to protect jaw face
- Designed to fit any 3" – 6" vise jaws, including all WILTON® and Columbian® vises
- Magnetic back mounts securely to jaw
- Great for holding wood, metal and tubing
- One size fits all

## WOODWORKING FEATURES

### SELF CENTERING JAW:

- Ensure a strong hold on all workpieces no matter what the shape

### FRONT JAW:

- Pivots 10° to allow for irregular shaped parts

### PIVOT JAW:

- Can be removed for wider clamping requirements

## IDEAL FOR

- Woodworking
- Light Tradesman

## LIGHT-DUTY FEATURES

### HIGH-TENSILE IRON JAWS:

- Provide strength and durability

### LIGHTWEIGHT DESIGN:

- Perfect for home craftsmen

### COLD ROLLED STEEL GUIDE BARS:

- Offer strength and integrity to the tool

Stock No.	Model	Jaw Width (in.)	Jaw Opening (in.)	Type of Nut	Replacement Jaw Insert No.	Net Weight (lbs.)
<b>WOODWORKING VISES</b>						
63144	78A	4 x 7	10	Rapid	63142	32
63218	79A	4 x 10	13	Rapid	63143	36
<b>LIGHT-DUTY WOODWORKING VISE</b>						
33176	176	6-1/2	4-1/2	-	-	6

Stock No.	Model	Jaw Width (in.)	Net Weight (lbs.)
<b>MODEL P-PRISM</b>			
14846	P-4	4	1
14847	P-4.5	4-1/2	1
14848	P-5	5	1
14873	P-5.5	5-1/2	1
14849	P-6	6	1
14876	P-6.5	6-1/2	1
<b>MODEL R-RUBBER FACE</b>			
14838	R-3	3	1
14840	R-4	4	1
14841	R-4.5	4-1/2	1
14842	R-5	5	1
14872	R-5.5	5-1/2	1
14843	R-6	6	1
14875	R-6.5	6-1/2	1

Stock No.	Model	Jaw Width (in.)	Net Weight (lbs.)
<b>MODEL A-ALUMINUM</b>			
14828	A-4	4	1
14829	A-4.5	4-1/2	1
14830	A-5	5	1
14871	A-5.5	5-1/2	1
14831	A-6	6	1
14874	A-6.5	6-1/2	1
<b>COPPER JAW CAPS</b>			
24403	404-3	3	1
24404	404-3-1/2	3-1/2	1
24405	404-4	4	1
24406	404-4-1/2	4-1/2	1
24407	404-5	5	1
63203	404-5-1/2	5-1/2	2
24408	404-6	6	2
63204	404-6-1/2	6-1/2	3
24409	404-8	8	4

Stock No.	Model	Jaw Width (in.)	Net Weight (lbs.)
<b>MODEL F-FIBER FACE</b>			
14834	F-4	4	1
14835	F-4.5	4-1/2	1
14836	F-5	5	1
14837	F-6	6	1
<b>MULTI-GRIP VISE JAWS</b>			
21111	21111	5-1/2	1



# WILTON® POW-R-ARMS

**MADE IN  
USA**

## WORKHOLDING SUPPORT FOR PRODUCTION LINES

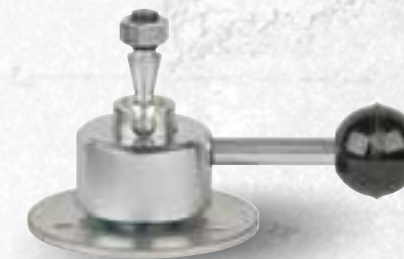

### POW-R-ARM™ MECHANICAL NO. 301

- Extra-strong, positioner with exceptionally fast on-off action, the 301 is designed for high production assembly line applications.
- Body is machined cast iron with all steel parts
- Two mounting holes at top (5/16-18) are 1" apart

### POW-R-ARM™ HYDRAULIC NO. 303

- Same size and strength as Model 301 with hydraulic locking action
- Rated for heavy-duty assembly, welding, maintenance and tool room work
- Hydraulic system is hand operated, self-contained and sealed with replaceable cups
- Two mounting holes at top (5/16-18) holes 1" apart

### POW-R-ARM™ JUNIOR NO. 343

- Fast on-off action with horizontal-moving lock handle
- Body is cast aluminum with steel parts
- 3" diameter mounting pad with two 1/4 - 20 holes
- 180° apart. Four slotted equally spaced 9/32" diameter mounting holes

### POW-R-ARM™ VEEP NO. 344

- Design provides more work-holding capacity and faster on-off action
- Horizontal handle is easily accessible and dwells below level of work
- Steel body is cadmium plated with cast iron base
- Mounting hole at top is 1/2" diameter x 1/2" deep with set screw to hold a fixture
- Four 1/4" diameter equally spaced slotted mounting holes
- For light production assembly or electronic applications

### POW-R-ARM™ MIDGET NO. 345

- Recommended for intricate electronic work including small printed circuits.
- Fast on/off action with horizontal handle
- All steel parts
- Mounting stud at top is 5/16-24 x 15/32" long

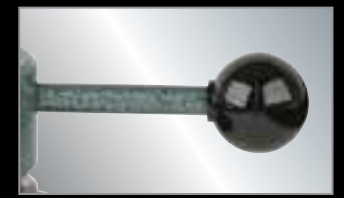

ERGONOMIC HANDLES



MACHINED STEEL PARTS



CAST IRON & ALUMINUM  
BODY CONSTRUCTION



## IDEAL FOR

- Production Environments
- Assembly Lines
- Intricate Work
- Fab Shops
- Electronic MRO



POW-R-ARMS have been popular in production lines for decades. Seen here in use at Burroughs Corporation, circa 1956.

Stock No.	Model	Workholding Capacity (lbs.)	Base Diameter (in.)	Diameter Bolt Circle (in.)	Extended Height (in.)	Net Weight (lbs.)
<b>POW-R-ARM MECHANICAL NO. 301</b>						
16240	301	70	5-15/16	5	10-1/2	14
<b>POW-R-ARM HYDRAULIC NO. 303</b>						
16300	303	150	5-7/8	5	10-1/2	15
<b>POW-R-ARM JUNIOR NO. 343</b>						
16180	343	30	4-1/4	2-1/4	5	4
<b>POW-R-ARM VEEP NO. 344</b>						
16120	344	20	3-3/4	3-3/8	4-1/4	3
<b>POW-R-ARM MIDGET NO. 345</b>						
16060	345	6	2-1/2	1-7/8	1-1/4	1





# TRUCK HITCH VISE

**YOUR TRUCK JUST GOT ONE HELL OF AN UPGRADE**

Some jobs go beyond the workshop. Some jobs make you come to them. For the jobs that demand function, strength and mobility, we present the ATV All-Terrain Vise.



**5" ATV®**



**6" ATV®**



**6" ATV® WITH CARRYING CASE**



**ATV® ACCESSORIES**

# ATV® ALL-TERRAIN VISE

SECURE IT IN YOUR HITCH OR MOUNT IT ON YOUR BENCH



6" ATV WITH CARRYING CASE



6" ATV



5" ATV



MOUNTING BRACKET (INCLUDED WITH 6" ATV)



FITS 2" HITCH, HITCH PIN INCLUDED



LARGE STRIKING ANVIL



360° LOCKING HANDLE



DRIVE TIGHT SET SCREWS



CARRYING HANDLE SCREWS



## FEATURES

### DRIVE TIGHT SET SCREWS:

- Patented set screws adjust to provide a tight fit in the hitch and reduce vibration while driving

### 360 LOCKING HANDLE

- Secures the handle while driving or repositions it while working

### PIPE JAWS:

- Pipe jaws clamp round objects up to 3"

### REPLACEABLE JAWS:

- Include a V-groove for verticle clamping of round objects

### LARGE ANVIL:

- Large striking anvil for forming and shaping materials.

### MOUNTING BRACKET

- Can be mounted on a bench or trailer for even greater versatility
- Included with 6" ATV (SKUs 10010 and 10015)

## IDEAL FOR

- Construction
- Farm and ranch
- Automotive
- Off roaders



Stock No.	Jaw Width (in.)	Maximum Opening (in.)	Throat Depth (in.)	Pipe Jaw Capacity (in.)	Net Weight (lbs.)
<b>ATV® – ALL-TERRAIN VISE</b>					
10025	5	6	4-1/4	7/8-3	25-1/2
10010	6	5-3/4	5	3/4-3	34
<b>ATV® – ALL-TERRAIN VISE WITH CARRYING CASE</b>					
10015	6	5-3/4	5	3/4-3	44
<b>ATV® – ACCESSORIES*</b>					
10055	10" Riser				5
10065	Locking Hitch Pin				1
10300	Mounting Bracket				6
10350	Carrying Case				10

\* Accessories fit both sizes of ATV



# VERTI-LOCK<sup>®</sup> MILLING MACHINE VISE

ACCURATE, SOLID & TRUE

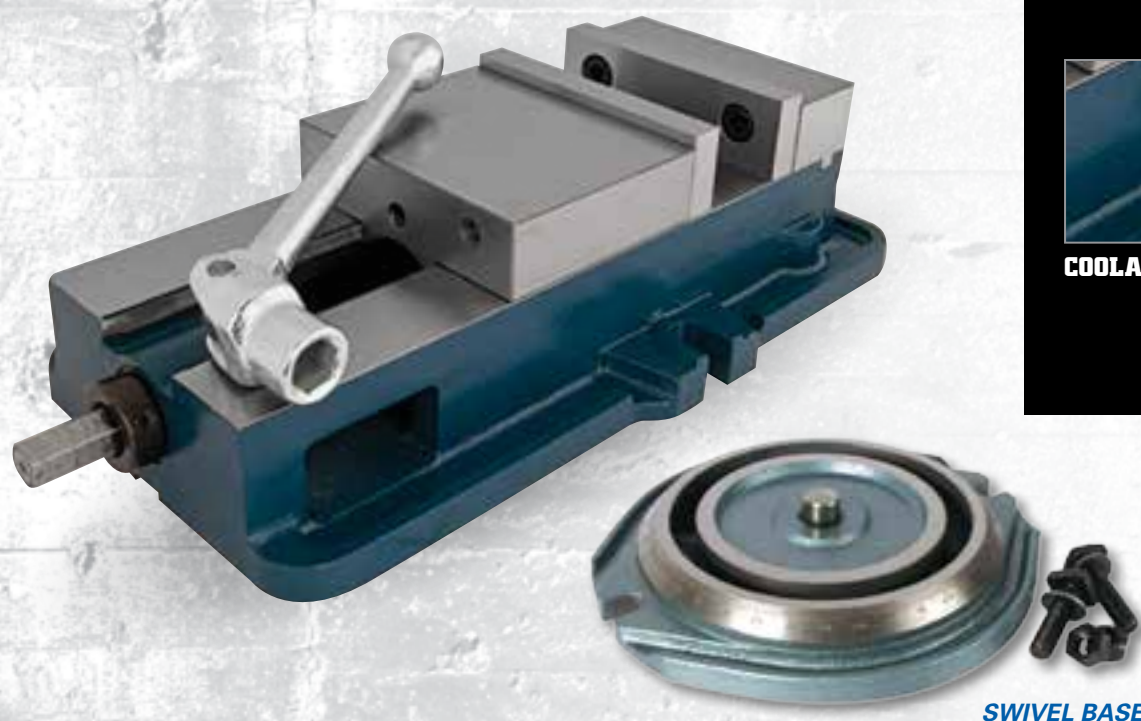

FLAME HARDENED BED



HARDENED JAWS



COOLANT DRAIN



SWIVEL BASE

## COMMON FEATURES

### WISE BODY:

- The ductile alloy vise body with flame-hardened bed provides solid work support, accuracy, and longevity

### WISE JAWS:

- The fixed jaw is rated at 85,000 PSI and the annealed, surface ground sliding jaw at 70,000 PSI

### SPINDLE:

- Fully enclosed spindle is protected from milling elements
- Cut from special alloy steel, hardened and ground

Stock No.	Model	Jaw Width (in.)	Jaw Depth (in.)	Jaw Opening (in.)	Net Weight (lbs.)
<b>STANDARD VISE ONLY</b>					
12390	1250N	5	1-7/16	4-1/2	50
63186	1275N	6	1-3/4	7-1/2	75
12375	1280N	8	2-1/4	7-1/2	164
<b>SWIVEL BASE ONLY</b>					
12285	5S	5	-	-	20
12290	6S	6	-	-	26
12295	8S	8	-	-	48

# SUPER PRECISION MACHINE VISES

ANGULAR & SELF CENTERING PRECISION



## SUPER PRECISION 3-AXIS TILTING

- Perfect vise for 3-axis jobs in milling, drilling, grinding, shaping and jig boring
- Vise bodies are constructed of close grained, high tensile, seasoned alloy castings
- Ergonomically designed all steel handle with spring loaded ball attachment
- Durable polychromatic finish
- Hardness of Jaws 55 ± 3HRC



## SUPER PRECISION 2-AXIS ANGULAR

- Perfect vise for applications where the workpiece requires machining on an angle
- Vise bodies are constructed of close grained, high tensile, seasoned alloy castings
- All ground surfaces made to close tolerances
- Ergonomically designed all steel handle with spring loaded ball attachment
- Hardness of Jaws 55 ± 3HRC



## SUPER PRECISION SELF CENTERING

- Very convenient for use with drilling and milling machines where quick centering is required
- Allows for accurate centering of jobs automatically
- Special design allows accurate setting up of jobs with only a single machine setting

Stock No.	Model	Jaw Width (in.)	Jaw Depth (in.)	Jaw Opening (in.)	Net Weight (lbs.)
<b>SUPER PRECISION 3-AXIS TILTING</b>					
11700	TLT/SP-50	2	1	2	10
11701	TLT/SP-75	3	1-5/16	3	26
11702	TLT/SP-100	4	1-1/2	4	52
11803	TLT/SP-125	5	1-3/4	5	84
11804	TLT/SP-150	6	1-3/4	6	119

Stock No.	Model	Jaw Width (in.)	Jaw Depth (in.)	Jaw Opening (in.)	Net Weight (lbs.)
<b>SUPER PRECISION 2-AXIS TILTING</b>					
11703	AMV/SP-50	2	15/16	2	8
11704	AMV/SP-75	3	1-5/16	3	22
11705	AMV/SP-100	4	1-9/16	4	43
11706	AMV/SP-125	5	2	5	74
11707	AMV/SP-150	6	2	6	101

Stock No.	Model	Jaw Width (in.)	Jaw Depth (in.)	Jaw Opening (in.)	Net Weight (lbs.)
<b>SUPER PRECISION SELF CENTERING VISE</b>					
11713	SCV/SP-100	4	1-1/2	4	34



# DRILL PRESS VISES

## VERSATILITY AND SPEED

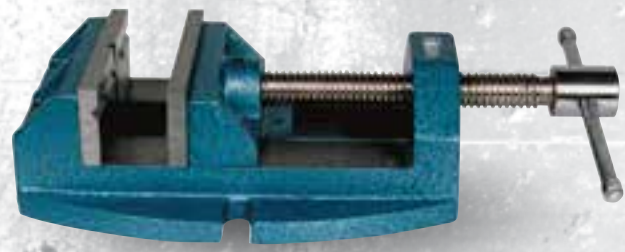

### VERSATILE DRILL PRESS VISES

- Rapid acting nut disengages spindle for quick adjustments
- Made from high grade cast iron
- Ground vise bed for smooth, consistent jaw movement
- Hardened top V-groove jaws
- Rugged design and large workload capacity

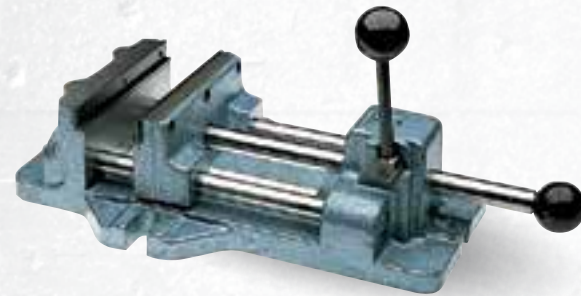

### CAM ACTION DRILL PRESS VISES

- Simple push or pull on the center bar knob sets the jaw in position
- Easy press locking lever cams the jaw ahead 3/32", exerting a holding pressure that is adjustable from 400 to 1100 lbs.
- Base is designed for clear through drilling applications
- Unique top locking lever can be raised or lowered to tighten or loosen against the work piece.

# DRILL PRESS VISES

## GENERAL PURPOSE

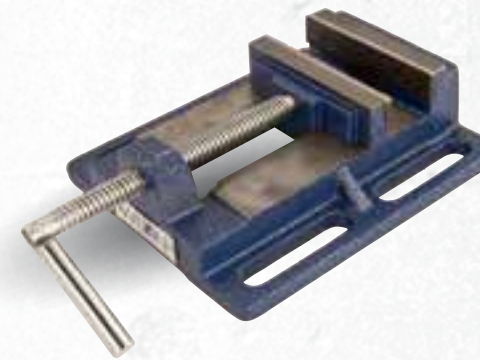

### STANDARD DRILL PRESS VISE

- 4" Jaw width opens to a maximum of 4-1/2"
- Grooved jaws provide a firm, secure grip on your work material
- Elongated holes for easy fastening onto drill presses or work surfaces



### INDUSTRIAL DRILL PRESS VISES

- Designed for applications including drilling, tapping, reaming and grinding
- Durable base has bolt lugs for easy mounting on a machine table
- Hardened V Grooved Jaws hold round shaped objects both vertically and horizontally
- Zinc plated fine threaded screw provides smooth clamping action

Stock No.	Model	Jaw Width (in.)	Jaw Opening (in.)	Jaw Depth (in.)	Net Weight (lbs.)
<b>VERSATILE – CONTINUOUS NUT</b>					
63238	1335	3	2-3/4	1-7/8	6
63239	1345	4	4	2-1/8	12
63240	1360	5	5	2-1/8	20
<b>VERSATILE – RAPID ACTING NUT</b>					
63242	1445	4-1/2	4-3/4	1-7/8	15
63243	1460	6	6-3/4	2-1/8	29

Stock No.	Model	Jaw Width (in.)	Jaw Opening (in.)	Jaw Depth (in.)	Net Weight (lbs.)
<b>CAM ACTION</b>					
13400	1203	3	3	1-1/4	10
13401	1204	4	4-11/16	1-5/16	18
13402	1206	6	6-3/16	1-13/16	35
13403	1208	8	8-3/16	2	53

Stock No.	Model	Jaw Width (in.)	Jaw Opening (in.)	Jaw Depth (in.)	Replacement Jaw Insert No.	Net Weight (lbs.)
<b>STANDARD DRILL PRESS VISE</b>						
69997	1203	4	4-1/2	1-1/2	-	7

Stock No.	Model	Jaw Width (in.)	Jaw Opening (in.)	Jaw Depth (in.)	Replacement Jaw Insert No.	Net Weight (lbs.)
<b>INDUSTRIAL DRILL PRESS VISES</b>						
11674	DI44	4	4	1-1/2	11674-01	10
11676	DI66	6	6	2	11676-01	35



# DRILL PRESS VISES

## GENERAL PURPOSE

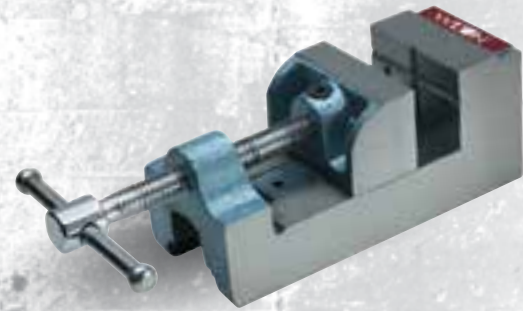

### STANDARD THREE-SIDED DRILL PRESS VISES

- Precision grinding of sides and front side face permits additional mounting positions for drilling, tapping or reaming
- Combining a smooth moveable jaw plate with a cross-patterned 90° V groove stationary jaw.
- The vise is recommended for general use.



### LOW PROFILE DRILL PRESS VISES

- Designed for applications including drilling, tapping and reaming
- Low profile clearance for increased working room on machine table
- Hardened V Grooved Jaws hold round shaped objects both vertically and horizontally
- Durable construction with fine grain cast iron castings and hardened steel vise jaws
- Black oxide coated ACME threaded screw provides consistent clamping pressure
- Highly accurate with beds and bases parallel to  $\pm .001"$

# DRILL PRESS VISES

## PRECISE ANGLED DRILLING



### CRADLE STYLE ANGLE DRILL PRESS VISE

- Designed for applications including drilling, tapping and reaming requiring angle setup
- Cradle design with 90° vertical indexing, scaled in 1° increments
- Side tommy bar allows secure locking at any increment from 0° - 90°
- Pin hard stops at 0°, 15°, 30°, 45°, 60°, 75° and 90° for common applications
- Durable construction with fine grain cast iron castings and hardened smooth vise jaws

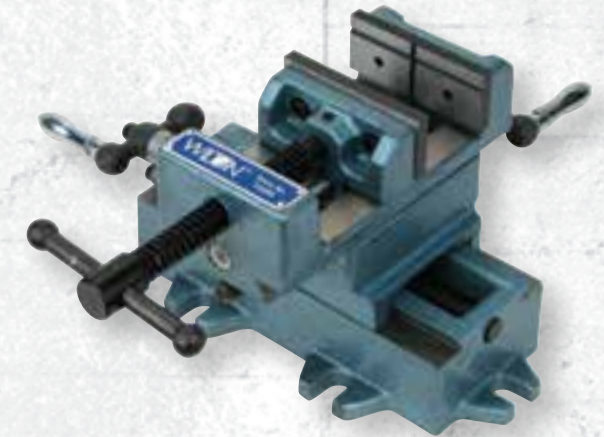

### CROSS SLIDE DRILL PRESS VISES

- Accurately moves your workpiece horizontal and longitudinal for precise positioning
- Cast side knobs accurately dial in .1mm increments
- Hardened V Grooved Jaws hold round shaped objects both vertically and horizontally
- Durable construction with fine grain cast iron castings
- Black oxide coated screw provides consistent clamping pressure
- Durable base has 5 bolt lugs for easy mounting on a machine table

Stock No.	Model	Jaw Width (in.)	Jaw Opening (in.)	Jaw Depth (in.)	Net Weight (lbs.)
<b>STANDARD THREE-SIDED DRILL PRESS VISES</b>					
12800	25	2-1/2	2-9/16	1-1/2	6
12860	30	3	3-1/8	1-3/4	10

Stock No.	Model	Jaw Width (in.)	Jaw Opening (in.)	Jaw Depth (in.)	Replacement Jaw Insert No.	Net Weight (lbs.)
<b>LOW PROFILE DRILL PRESS VISES</b>						
11743	LP3	3	3	1-1/8	11743-01	8
11744	LP4	4	4	1-1/2	11744-01	12
11746	LP6	6	6	2	11746-01	30
11748	LP8	8	8	2	11748-01	50

Stock No.	Model	Jaw Width (in.)	Jaw Opening (in.)	Jaw Depth (in.)	Replacement Jaw Insert No.	Net Weight (lbs.)
<b>CRADLE STYLE ANGLE DRILL PRESS VISE</b>						
11753	CR3	4	3	1-1/8	11753-01	12
11754	CR4	6	4	1-1/2	11754-01	17

Stock No.	Model	Jaw Width (in.)	Jaw Opening (in.)	Jaw Depth (in.)	X-Travel (in.)	Y-Travel (in.)	Replacement Jaw Insert No.	Net Weight (lbs.)
<b>CROSS SLIDE DRILL PRESS VISES</b>								
11693	CS3	3	3	1-1/8	4-9/10	4-9/10	11693-01	16
11694	CS4	4	4	1-3/8	4-9/10	4-9/10	11694-01	20
11695	CS5	5	5	1-1/2	5-9/10	5-9/10	11695-01	45
11696	CS6	6	6	2	7-9/10	7-9/10	11696-01	59
11698	CS8	8	8	2	7-9/10	7-9/10	11698-01	77



# STRUT CUTTER

CLEANER. FASTER. SAFER.

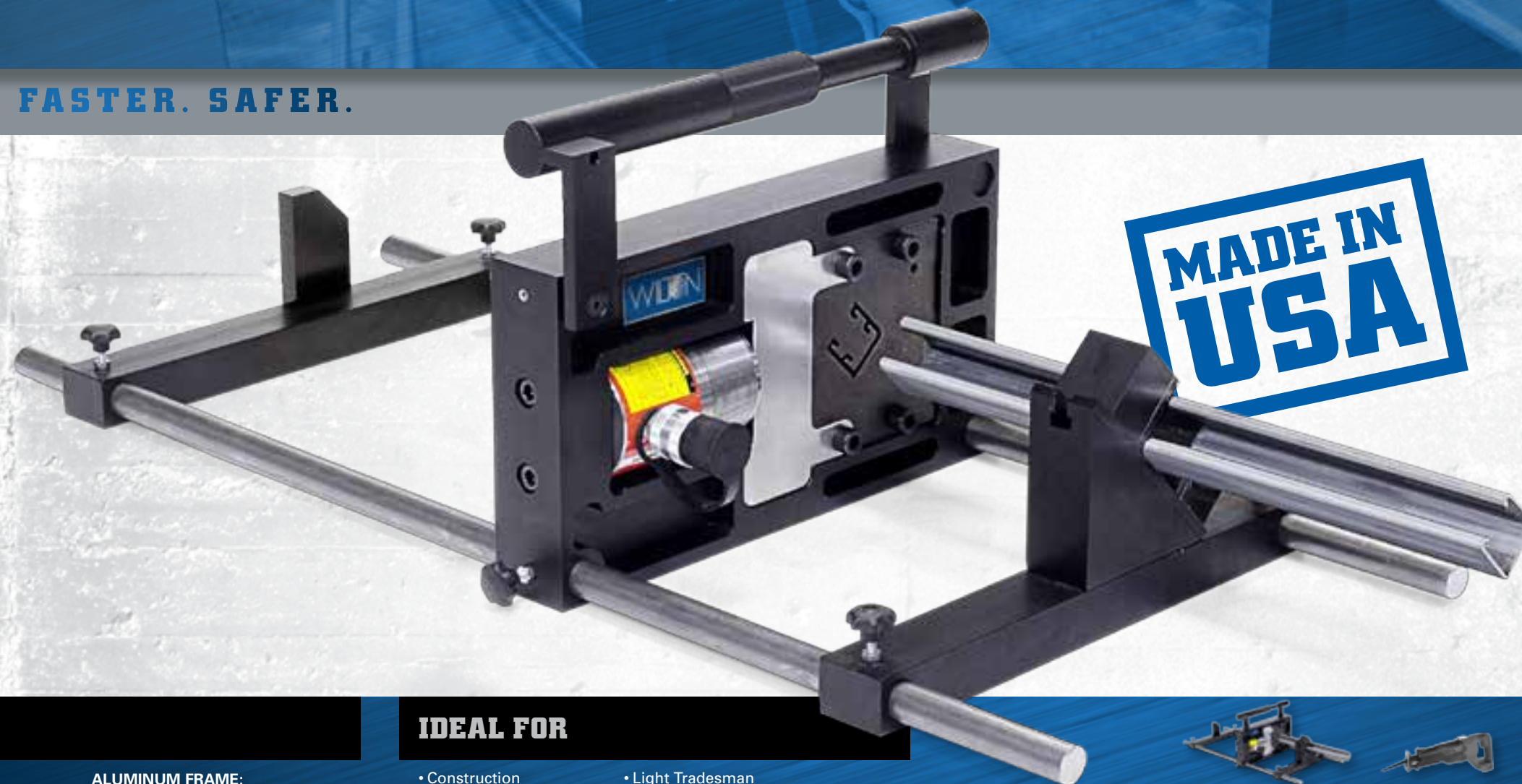

BACK GUAGE



COLLAPSIBLE HANDLE



25 TON HYDRAULIC CYLINDER



ALUMINUM FRAME

## FEATURES

### BACK GUAGE:

- Adjustable back guage allows for quick production shearing for uniform lengths

### COLLAPSIBLE HANDLE SYSTEM:

- The collapsible handle provides easy movement on the job site
- Handle doubles as support legs

### 25 TON HYDRAULIC CYLINDER:

- Compact and powerful, the 25 ton cylinder easily pushes through any production job
- The quick-couple connects to any 10,000 psi power supply

### ALUMINUM FRAME:

- The Wilton Strut Cutter's 7075-T651 precision-machined, anodized aluminum frame is durable enough to last a lifetime

### CUTTING DIES:

- EDM profiled, heat-treated S7 tool steel dies are available in standard and custom profiles
- Make thousands of cuts with no waste and no post-cut processing
- Custom profiles available.

### MATERIAL REST:

- Hold any strut securely with the adjustable machined material rest

## IDEAL FOR

- Construction
- Production Environments
- Fab Shops
- Light Tradesman
- Maintenance and Repair

Stock No.	Product Description
<b>WILTON® STRUT CUTTER ACCESSORIES</b>	
ESP1105	Wilton Strut Cutter Power Kit
ESP1110	Wilton Strut Cutter Starter Pack
ESP1159	Wilton Strut Cutter Standard Blade Set
ESP1159-1	Wilton Strut Cutter Custom Blade Set
ESP1160	Wilton Strut Cutter Blade Set B-Line B22 and B52
ESP1161	Wilton Strut Cutter Blade Set B-Line 4Dimension 4D21
ESP1162	Wilton Strut Cutter Blade Set B-Line 4Dimension 4D22
ESP1163	Wilton Strut Cutter Material Rest Assembly



	Wilton Strut Cutter	Reciprocating Saw	Abrasive Saw	Portaband Saw	Metal Cutting Saw
Cutting Cycle	3 seconds	70 seconds	29 seconds	28 seconds	7 seconds
Change Cycle	7 seconds	7 seconds	7 seconds	7 seconds	7 seconds
De-burring	0 seconds	10 seconds	10 seconds	10 seconds	10 seconds
Total Cut Time	10 seconds	87 seconds	46 seconds	45 seconds	24 seconds
Total Cuts/Hr.	360	41	78	80	150
Total Cuts/Day	2880	328	624	640	1200
Labor Cost/Cut	\$0.14	\$1.20	\$0.63	\$0.62	\$0.33

Costs per cut test results were calculated using a qualified test tool and self test documentation.

Stock No.	Deep Strut (in.)	Shallow Strut (in.)	Max. Capacity (gauge)	Cylinder (tons)	Unit Weight (lbs.)	Guides (lbs.)	Height (in.)	Height with Handles (in.)	Width (in.)	Depth (in.)
<b>WILTON® STRUT CUTTER</b>										
ESP1100	1-5/8 x 1-5/8	1-5/8 x 13/16	12	25	49	13.5	9	13	17	5.5

# COLD FRONT™ 3037 ATOMIZING COOLING FAN

EFFECTIVE. PORTABLE

## HEAT: A HAZARD YOU CAN'T AFFORD

When the temperature rises, so do on-the-job risks. Damaged equipment. Lost productivity. Serious injury. You could accept these risks as the status quo. Or you could beat the heat for good—with the Wilton® Cold Front™ 3037 Atomized Cooling Fan.



### BEAT HEAT

Protect workers from hazardous conditions



### BEAT HUMIDITY

Reduce discomfort and equipment damage



### BEAT INEFFICIENCY

Keep cool without disrupting workflow



SAVES EFFORT



ADDS POWER



WORKS LONGER



MOVES EASIER

## FEATURES

### EFFECTIVE

- Cools over 3,000 sq. ft.
- Minimal increase in humidity

### SAFE

- Keeps workers cool
- Reduced chance of water damage
- No puddles, drips or slipping hazards

### FAST

- Flash evaporation starts cooling quickly
- Instant startup and shutdown

### DURABLE

- Galvanized steel and aluminum construction
- Plastic water tank will not rust
- No pads or filters to replace

## IDEAL FOR

- Automotive
- Production Environments
- Fab Shops
- Light Tradesman
- Maintenance and Repair
- Warehouse and Dock

**MADE IN  
USA**

Electrical Supply	Cooling Coverage (ft²)	Air Flow (CFM)	Velocity (mph)	Water Output Rate (gal/hr)	Amperage (A)	Fan Diameter (in.)	Fan Speed Settings	Fan Drive	Sound Level (db)	Water Capacity (gal.)	Water Supply	Unit Dimensions (in.)
WILTON® COLD FRONT™ 3037 ATOMIZED COOLING FAN												
120 VAC / 60 Hz	3,161	8,462	22.3	1.74	10.3	30	1	direct	77.5 at 5 ft.	19	tank (no hose)	45 L x 24 W x 56 H





# WILTON F-CLAMPS

THE WELDER'S CHOICE

At Wilton®, we know welding. As the leader in professional grade workholding equipment for more than 75 years, we understand the intricacies of your work. That's why we are proud to introduce our full line of welding F-Clamps.

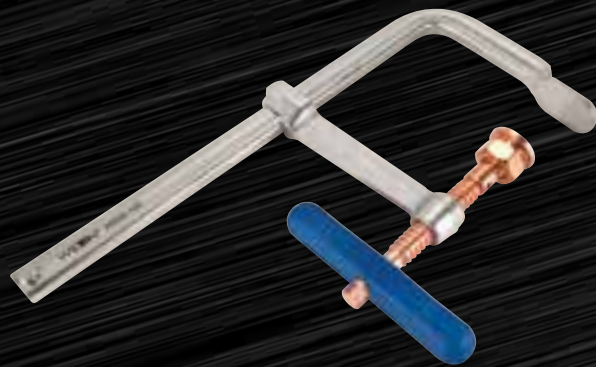

**SPARK-DUTY™  
COPPER PLATED  
F-CLAMPS**



**CLASSIC SERIES  
F-CLAMPS**



**LEVER  
CLAMPS**



# SPARK-DUTY™ COPPER-PLATED F-CLAMPS

THE SERIOUS WELDER'S CHOICE

BUILT FOR IRREGULAR SHAPES

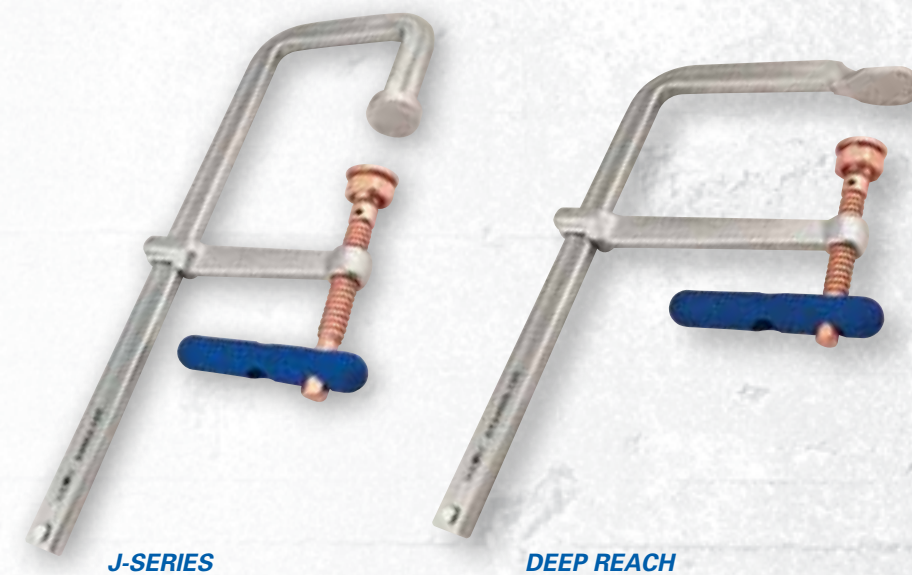
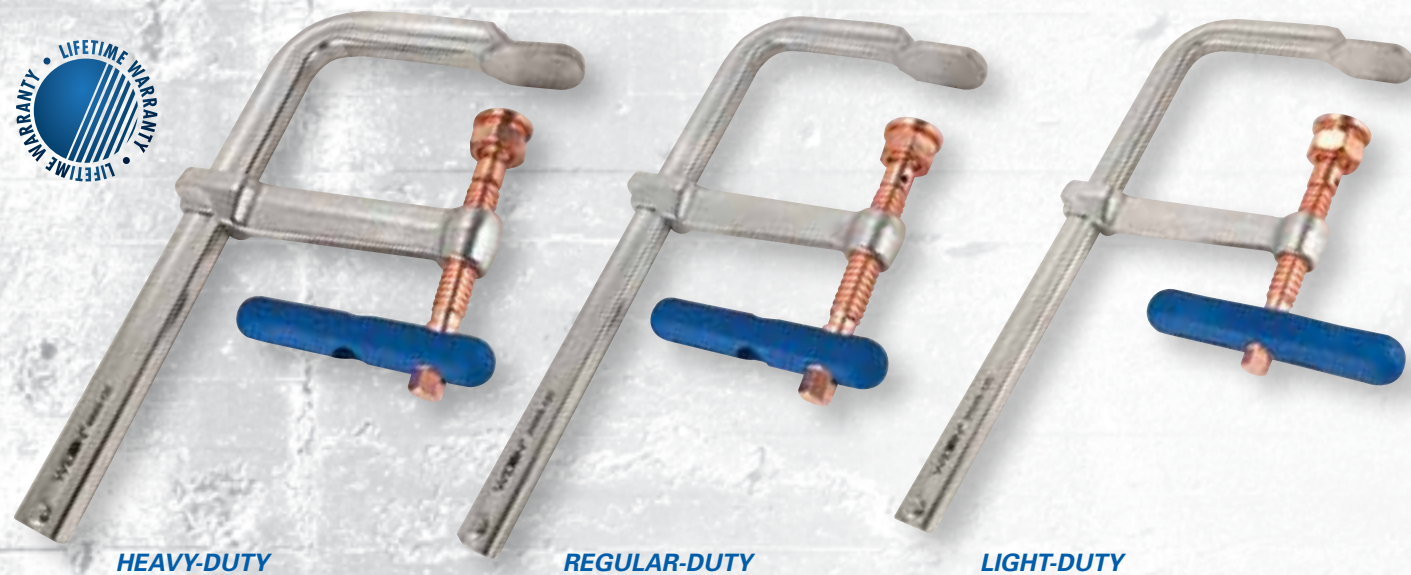

V-GROOVE PAD INCLUDED



ERGONOMIC GRIP INCLUDED



COPPER-PLATED SPINDLE

## FEATURES

### DROP-FORGED ARM:

- Minimal flex under heavy workloads

### SPARK-DUTY™ COPPER-PLATED SPINDLE:

- Extends the life of the clamp by protecting the spindle and pad from harmful welding spatter

### QUICK-TWIST PADS:

- Simple and fast replaceable pads in V-Groove or serrated surfaces

### V-GROOVE PAD

- Included with every clamp. Clamp round objects up to 14" in diameter

### ERGONOMIC WILTON-GRIP®:

- Anti-Fatigue Wilton-Grip® provides comfort during repetitive clamping

Stock No.	Model	Nominal Opening Capacity (in.)	Throat Depth (in.)	Clamping Force (lbs.)	Net Weight (lbs.)
<b>SPARK-DUTY™ 4800S SERIES – HEAVY-DUTY</b>					
86500	4800S-12C	12	7	4,880	12
86510	4800S-18C	18	7	4,880	15
86520	4800S-24C	24	7	4,880	16
86530	4800S-36C	36	7	4,880	21
86540	4800S-48C	48	7	4,880	24
86550	4800S-60C	60	7	4,880	27
<b>SPARK-DUTY™ 2400S SERIES – REGULAR-DUTY</b>					
86400	2400S-8C	8	5-1/2	2,660	6
86410	2400S-12C	12	5-1/2	2,660	7
86420	2400S-16C	16	4-3/4	2,660	7
86430	2400S-20C	20	5-1/2	2,660	8
86440	2400S-24C	24	4-3/4	2,660	9
86450	2400S-36C	36	5-1/2	2,660	12
86460	2400S-48C	48	5-1/2	2,660	14
86470	2400S-60C	60	5-1/2	2,660	15
<b>SPARK-DUTY™ 2000S SERIES – LIGHT-DUTY</b>					
86300	2000S-8C	8	4-3/4	2,000	5
86310	2000S-12C	12	5-1/2	2,000	5
86320	2000S-18C	18	4-3/4	2,000	6
86330	2000S-24C	24	4-3/4	2,000	7

## FEATURES

### J-SHAPED RAIL (J-SERIES):

- Steps over I-Beams and irregular shapes

### INCREASED THROAT DEPTH (DEEP REACH):

- Provides deeper reach for unique projects

### SPARK-DUTY™ COPPER-PLATED SPINDLE:

- Extends the life of the clamp by protecting the spindle and pad from harmful welding spatter

### QUICK-TWIST PADS:

- Simple and fast replaceable pads in V-Groove or serrated surfaces

### V-GROOVE PAD

- Included with every clamp. Clamp round objects up to 16" in diameter

### ERGONOMIC WILTON-GRIP®:

- Anti-Fatigue Wilton-Grip® provides comfort during repetitive clamping

Stock No.	Model	Nominal Opening Capacity (in.)	Throat Depth (in.)	Clamping Force (lbs.)	Net Weight (lbs.)
<b>SPARK-DUTY™ J-SERIES</b>					
86900	1200J-10C	10	4-3/4	1,200	4
86910	2400J-12C	12	5-1/2	2,400	8
86920	4800J-20C	20	7	4,800	19
<b>SPARK-DUTY™ DEEP REACH</b>					
86700	DT2400S-12C	12	8	1,770	8
86710	DT2400S-24C	24	8	1,770	10



# SPARK-DUTY™ WELDERS SHOE CLAMP

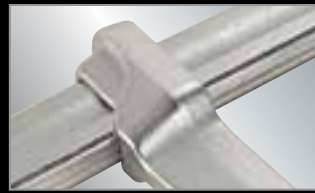
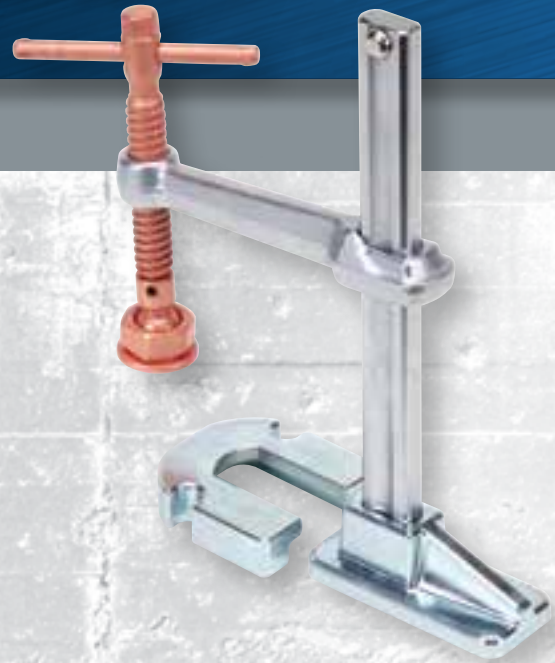

FORGED SLIDE ARM



PERMA-PADS®



COPPER-PLATED SPINDLE

# COPPER PLATED SPARK-DUTY™ F-CLAMP ACCESSORIES



## FEATURES

### SPARK-DUTY™ COPPER-PLATED SPINDLE:

- Extends the life of the clamp by protecting the spindle and pad from harmful welding spatter

### HEAVY-DUTY SHOE:

- Bolt or weld shoe to workstation for maximum stability

### DROP-FORGED ARM:

- Slides up and down robust rail for rapid loading

Stock No.	Model	Nominal Opening Capacity (in.)	Throat Depth (in.)	Nominal Rail Size (in.)	Clamping Force (lbs.)	Nominal Spindle Diameter (in.)	Net Weight (lbs.)
<b>SPARK-DUTY™ WELDERS SHOE CLAMP</b>							
63295	-	8-1/2	5-1/2	1-3/16 x 9/16	2,600	3/4	8

## IDEAL FOR

- Production work
- Repetitive welding
- High-efficiency



Stock No.	Model	Wilton Grip Stock No.	Plain Pad Stock No.	Serrated Pad Stock No.	V-Pad Stock No.	Nut Stock No.	Joint with Spring Pin Stock No.	Spindle and Handle with Spring Pin Stock No.
<b>SPARK-DUTY™ 2000S SERIES</b>								
86300	2000S-8C	1713511	2909101	2909201	2909301	1701701	1701501	1701601
86310	2000S-12C	1713551	2909101	2909201	2909301	1701701	1701501	1701601
86320	2000S-18C	1713511	2909101	2909201	2909301	1701701	1701501	1701601
86330	2000S-24C	1713511	2909101	2909201	2909301	1701701	1701501	1701601
<b>SPARK-DUTY™ 2400S SERIES</b>								
86400	2400S-8C	1713551	2909102	2909202	2909302	1701702	1701502	1701602
86410	2400S-12C	1713551	2909102	2909202	2909302	1701702	1701502	1701602
86420	2400S-16C	1713551	2909102	2909202	2909302	1701702	1701502	1701602
86430	2400S-20C	1713551	2909102	2909202	2909302	1701702	1701502	1701602
86440	2400S-24C	1713551	2909102	2909202	2909302	1701702	1701502	1701602
86450	2400S-36C	1713551	2909102	2909202	2909302	1701702	1701502	1701602
86460	2400S-48C	1713551	2909102	2909202	2909302	1701702	1701502	1701602
86470	2400S-60C	1713551	2909102	2909202	2909302	1701702	1701502	1701602
<b>SPARK-DUTY™ 4800S SERIES</b>								
86500	4800S-12C	1713561	2909102	2909202	2909302	1701702	1701502	1701603
86510	4800S-18C	1713561	2909102	2909202	2909302	1701702	1701502	1701603
86520	4800S-24C	1713561	2909102	2909202	2909302	1701702	1701502	1701603
86530	4800S-36C	1713561	2909102	2909202	2909302	1701702	1701502	1701603
86540	4800S-48C	1713561	2909102	2909202	2909302	1701702	1701502	1701603
86550	4800S-60C	1713561	2909102	2909202	2909302	1701702	1701502	1701603
<b>SPARK-DUTY™ DEEP REACH SERIES</b>								
86700	DT2400S-12C	1713551	2909101	2909201	2909301	1701701	1701501	1701601
86710	DT2400S-24C	1713551	2909101	2909201	2909301	1701701	1701501	1701601
<b>SPARK-DUTY™ J SERIES</b>								
86900	1200J-10C	1713551	2909100	2909200	2909300	1701700	1701500	1701600
86910	2400J-12C	1713551	2909102	2909202	2909302	1701702	1701502	1701602
86920	4800J-20C	1713561	2909102	2909202	2909302	1701702	1701502	1701603

# CLASSIC™ SERIES HEAVY-DUTY F-CLAMPS

NOTHING BEATS A CLASSIC

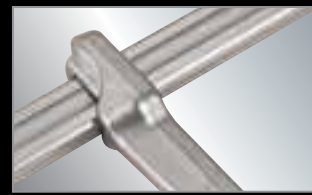
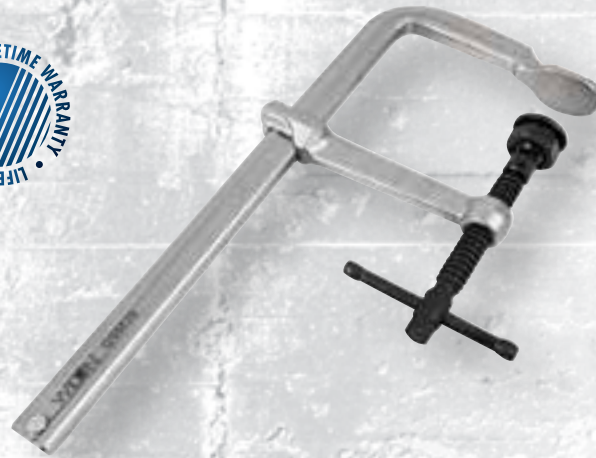

FORGED SLIDE ARM



STURDY TOMMY BAR



HEAVY DUTY  
REPLACEABLE PAD

## FEATURES

### BLACK OXIDE SPINDLES:

- Resist wear and tear while impeding rust

### DROP-FORGED ARM:

- Provides minimal flex under heavy workloads

### QUICK TWIST PADS:

- Heavy duty pads are simple and fast to replace

### STURDY TOMMY BAR:

- Engineered for durability and comfort

## IDEAL FOR

- Fabrication
- Welding
- Repetitive Clamping

Stock No.	Model	Nominal Opening Capacity (in.)	Throat Depth (in.)	Clamping Force (lbs.)	Net Weight (lbs.)
<b>CLASSIC HEAVY-DUTY F-CLAMPS</b>					
86640	GSM20	8	5-1/2	2,660	6
86650	GSM30	12	5-1/2	2,660	7
86660	GSM40	16	4-3/4	2,660	7
86670	GSM50	20	5-1/2	2,660	8
86680	GSM60	24	4-3/4	2,660	9

Stock No.	Plain Pad Stock No.	Serrated Pad Stock No.	V Pad Stock No.	Nut Stock No.	Joint w/ Spring Pin Stock No.	Spindle and Handle w/ Spring Pin Stock No.
<b>REPLACEMENT PARTS CLASSIC HEAVY-DUTY F-CLAMP</b>						
86640	2909102A	2909202A	2909302A	1701702A	1701502A	1701602B
86650	2909102A	2909202A	2909302A	1701702A	1701502A	1701602B
86660	2909102A	2909202A	2909302A	1701702A	1701502A	1701602B
86670	2909102A	2909202A	2909302A	1701702A	1701502A	1701602B
86680	2909102A	2909202A	2909302A	1701702A	1701502A	1701602B

# CLASSIC™ SERIES REGULAR & LIGHT DUTY F-CLAMPS

NOTHING BEATS A CLASSIC

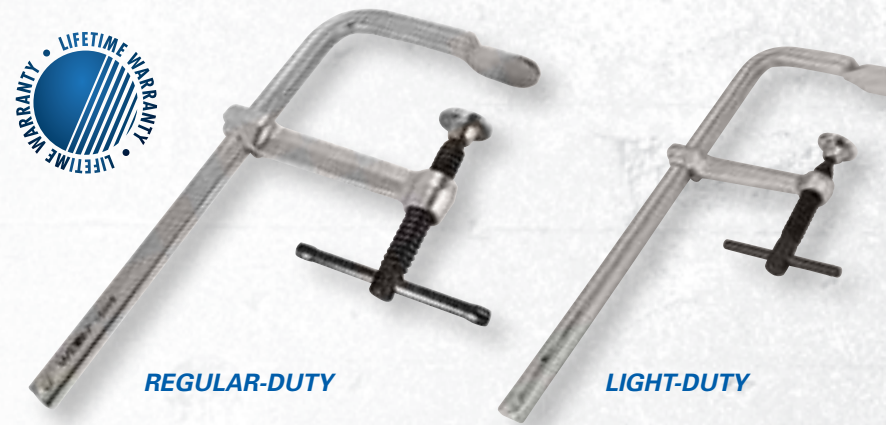

## FEATURES

### BLACK OXIDE SPINDLES:

- Resist wear and tear while impeding rust

### DROP-FORGED ARM:

- Provides minimal flex under heavy workloads

### SWIVEL PAD:

- Centers on workpiece for a sturdy hold

### STURDY TOMMY BAR:

- Engineered for durability and comfort

## IDEAL FOR

- Fabrication
- Welding
- Repetitive Clamping



FORGED SLIDE ARM



STURDY TOMMY BAR



OSCILLATING PAD

Stock No.	Model	Nominal Opening Capacity (in.)	Throat Depth (in.)	Clamping Force (lbs.)	Net Weight (lbs.)
<b>CLASSIC REGULAR-DUTY F-CLAMPS</b>					
86200	1800S-8	8	4-3/4	1,800	4
86210	1800S-12	12	5-1/2	1,800	5
86220	1800S-18	18	4-3/4	1,800	6
86230	1800S-24	24	4-3/4	1,800	6
<b>CLASSIC LIGHT-DUTY F-CLAMPS</b>					
86100	660S-8	8	4	660	2
86110	660S-12	12	4	660	2
86120	660S-18	18	4	660	3
86130	1200S-8	8	4-3/4	1,200	2
86140	1200S-12	12	4-3/4	1,200	3
86150	1200S-18	18	4-3/4	1,200	4
86160	1200S-24	24	4-3/4	1,200	4

# CLASSIC™ SERIES MINI F-CLAMPS

NOTHING BEATS A CLASSIC



FORGED SLIDE ARM



STURDY TOMMY BAR



OSCILLATING PAD

# HEAVY-DUTY LEVER CLAMPS

SPINDLELESS CLAMPS



QUICK RATCHETING  
DESIGN



SELF CENTERING PAD



ERGONOMIC HANDLE

## FEATURES

### BLACK OXIDE SPINDLES:

- Resist wear and tear while impeding rust

### DROP-FORGED ARM:

- Provides minimal flex under heavy workloads

### SWIVEL PAD:

- Centers on workpiece for a sturdy hold

### STURDY TOMMY BAR:

- Engineered for durability and comfort

Stock No.	Model	Nominal Opening Capacity (in.)	Throat Depth (in.)	Clamping Force (lbs.)	Net Weight (lbs.)
<b>CLASSIC MINI F-CLAMPS</b>					
86000	MMS-4	4	2-1/4	400	1
86010	MMS-8	8	2-1/4	400	1
86020	MMS-12	12	2-1/4	400	1

## IDEAL FOR

- Fabrication
- Welding
- Repetitive Clamping

## FEATURES

### RATCHETING DESIGN:

- Allows easy, spindle-free operation

### QUICK-TRIGGER RELEASE:

- Release clamp pressure with one squeeze

### WILTON® BLUE ALUMINUM HANDLE:

- Ergonomically designed for repetitive clamping and resistant to heat

### SELF CENTERING PAD:

- Centers on workpiece for a sturdy hold

Stock No.	Model	Nominal Opening Capacity (in.)	Throat Depth (in.)	Clamping Force (lbs.)	Net Weight (lbs.)
<b>LEVER CLAMPS</b>					
86800	LC4	4	2-3/8	350	2
86810	LC8	8	4	770	3
86820	LC12	12	5-1/2	1,100	3
86830	LC20	20	4-3/4	1,200	4





# WILTON® C-CLAMPS

QUALITY CLAMPING SOLUTIONS

Tried and true, Wilton® C-Clamps have been a part of American history stemming all the way back to the automotive boom in the 1950's. To this day, through evolutionary innovation, you will find the clamp for your application in our offering of over 135 different C-Clamps.



**BRUTE FORCE™  
C-CLAMPS**



**400 SERIES  
C-CLAMPS**



**4400 & 800  
C-CLAMPS**



**CARRIAGE  
C-CLAMPS**



**JUNIOR  
C-CLAMPS**



**SPECIALTY  
CLAMPS**

# BRUTE FORCE™ 0-SERIES C-CLAMPS

BRIDGE / BOILER CLAMPS

**MADE IN  
USA**



FULL LENGTH SPINDLE



SQUARE SPINDLE HEAD



40,000 LBS. OF PURE  
CLAMPING PRESSURE



**NOTE:**

• Meets federal spec # GGG-C-406D, Type I, Class D Heavy Service

## FEATURES

**HIGHEST CLAMPING PRESSURE:**

- Ranging up to 40,000 lbs. standing up to the demands of the heaviest industrial applications

**SPINDLE:**

- Full length, machined from a single piece of square, cold drawn steel, hardened and tempered

**SQUARE SPINDLE HEAD:**

- Stands up to heavy wrench tightening use, including both hand and torque wrench

## IDEAL FOR

- Heavy Construction
- Bridge Building
- Heavy Fabrication
- Ship Building

Stock No.	Model	Nominal Opening Capacity (in.)	Throat Depth (in.)	Clamping Force (lbs.)	Spindle Size (in.)	Net Weight (lbs.)
<b>BRUTE FORCE – 0 SERIES</b>						
14518	1 F.C.	0 – 1-3/8	1-3/32	5,600	7/16	1
14527	1-1/2 F.C.	0 – 1-3/4	1-3/16	8,750	5/8	2
14536	2 F.C.	0 – 2-3/8	1-7/8	12,500	3/4	3
14545	3 F.C.	0 – 3-5/16	2-5/16	16,250	7/8	7
14554	4 F.C.	0 – 4-1/2	2-3/4	20,000	1	10
14563	5 F.C.	0 – 5-1/4	3-1/8	23,800	1	14
14572	6 F.C.	0 – 6-1/4	3-3/8	27,500	1-1/8	19
14581	8 F.C.	0 – 8-1/2	3-5/8	31,250	1-1/4	26
14590	10 F.C.	0 – 10-1/4	3-15/16	35,000	1-1/4	37
14599	12 F.C.	0 – 12-3/8	4-1/4	40,000	1-1/4	44

# BRUTE FORCE™ 100-SERIES C-CLAMPS

15,000 LBS. OF PRESSURE

**MADE IN  
USA**



HARDENED AND  
TEMPERED STEEL  
SPINDLE



REPLACEABLE  
PERMA-PADS



SQUARE HEAD HANDLE



**NOTE:**

• Meets federal spec # GGG-C-406D, Type I, Class B Medium Service

## FEATURES

**SPINDLE:**

- Full length, machined from a single piece of square, cold drawn steel, hardened and tempered

**SQUARE HEAD HANDLE:**

- Designed for maximum torque and flexible usage
- Can be tightened by hand or wrench

## IDEAL FOR

- Heavy Construction
- Mining and Extraction
- Machine Tool Fixtures
- Press Work

Stock No.	Model	Nominal Opening Capacity (in.)	Throat Depth (in.)	Clamping Force (lbs.)	Spindle Size (in.)	Net Weight (lbs.)
<b>BRUTE FORCE – 100 SERIES</b>						
14114	102	0 – 2	1-1/2	7,500	9/16	2
14128	103	0 – 3	2	8,750	5/8	3
14142	104	0 – 4	2-1/4	10,000	3/4	4
14156	106	2 – 6	2-1/2	11,250	3/4	6
14170	108	4 – 8	2-3/4	12,500	3/4	8
14184	110	6 – 10	2-7/8	13,750	3/4	9
14198	112	8 – 12	2-15/16	15,000	3/4	12

# CLASSIC 400 SERIES™ C-CLAMPS

## DEEP THROAT CLAMPS



HI-VIS



V GROOVED ANVIL

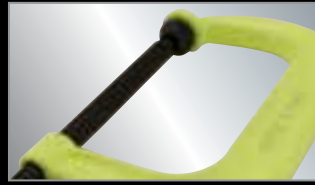

HI-VIS SAFETY  
YELLOW FRAME



REPLACEABLE  
PERMA-PADS



**NOTE:**

- Meets federal spec # GGG-C-406a, Type I, Class A, Grade a, Style 1 & 2
- Hi Vis conforms to OSHA safety color standard for physical regulation #1910.144

## FEATURES

**DROP FORGED:**

- Manufactured for greater strength under regular strength applications

**ACME ROLLED SPINDLE:**

- Threads provide continuous smooth operation for faster clamping action and maximum strength

**BLACK OXIDE COATING:**

- Spindles and PERMA-PADS® are treated to resist corrosion

**V GROOVED ANVIL:**

- Feature allows secure holding of all materials including rounds, squares and flats

## IDEAL FOR

- Steel Fabrication
- Industrial Maintenance
- Production
- Repair Operations

Stock No.	Model	Nominal Opening Capacity (in.)	Throat Depth (in.)	Clamping Force (lbs.)	Spindle Size(in.)	Net Weight (lbs.)
<b>CLASSIC 400 SERIES™</b>						
14214	402	0 – 2-1/8	2-1/4	3,500	9/16	2
14228	403	0 – 3	2-1/2	3,500	9/16	2
14242	404	0 – 4-1/4	3-1/4	6,200	3/4	4
14256	406	0 – 6-1/16	4-1/8	6,600	3/4	5
14270	408	0 – 8-1/4	5	6,900	3/4	8
14284	410	2 – 10-1/8	6	8,000	3/4	11
14298	412	2 – 12-1/4	6-5/16	9,300	7/8	14
<b>CLASSIC 400 SERIES™ HI-VIS SAFETY</b>						
14300	402-SF	0 – 2-1/8	2-1/4	3,500	9/16	1
14301	403-SF	0 – 3	2-1/2	3,500	9/16	2
14302	404-SF	0 – 4-1/4	3-1/4	6,200	3/4	4
14303	406-SF	0 – 6-1/16	4-1/8	6,600	3/4	5
14305	408-SF	0 – 8-1/4	5	6,900	3/4	7
14306	410-SF	2 – 10-1/8	6	8,000	3/4	11
14307	412-SF	2 – 12-1/4	6-5/16	9,300	7/8	15

# SPARK-DUTY™ 400P AND HI-VIS C-CLAMPS

## SPATTER RESISTANT COPPER

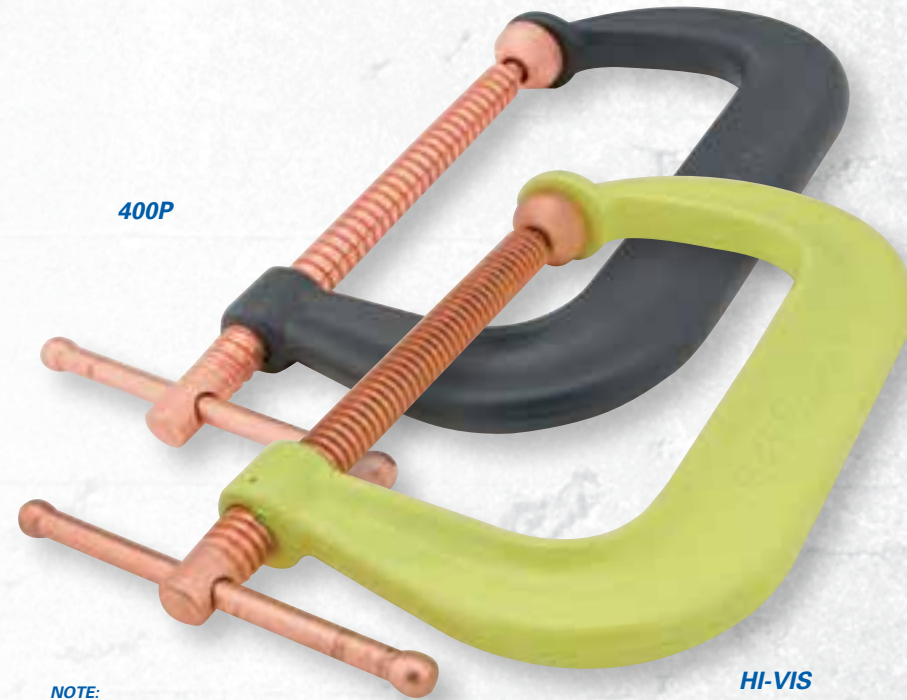

400P

HI-VIS



V-GROOVED ANVIL

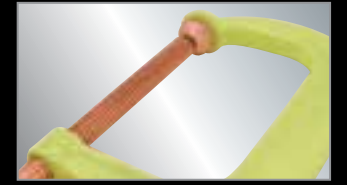

HI-VIS SAFETY  
YELLOW FRAME



COPPER PLATED SPINDLE  
AND PERMA-PADS®



**NOTE:**

- Hi Vis conforms to OSHA safety color standard for physical regulation #1910.144

## FEATURES

**DROP FORGED:**

- Manufactured for greater strength under regular strength applications

**V GROOVED ANVIL:**

- Feature allows secure holding of all materials including rounds, squares and flats

**ACME ROLLED SPINDLE:**

- Threads provide continuous smooth operation for faster clamping action and maximum strength

**COPPER PLATED:**

- Spindles and pads are copper plated to provide resistance to welding splatter and corrosion

## IDEAL FOR

- Steel Fabrication
- Industrial Welders

Stock No.	Model	Nominal Opening Capacity (in.)	Throat Depth (in.)	Clamping Force (lbs.)	Spindle Size(in.)	Net Weight (lbs.)
<b>SPARK-DUTY 400P</b>						
14215	402-P	0-2-1/8	2-5/8	3,500	9/16	2
14229	403-P	0-3	2-1/2	3,500	5/8	2
14243	404-P	0-4-1/4	3-1/4	6,200	3/4	4
14257	406-P	0-6-1/16	4-1/8	6,600	3/4	5
14271	408-P	0-8-1/4	5	6,900	3/4	8
14285	410-P	2-10-1/8	6	8,000	3/4	10
14299	412-P	2-12-1/4	6-5/16	9,300	7/8	15
<b>SPARK-DUTY 400CS HI-VIS</b>						
20479	H402CS	0 – 2	2	3,500	1/2	2
20481	H403CS	0 – 3	2-3/8	3,500	5/8	2
20483	H404CS	0 – 4	2-3/4	6,200	3/4	3
20484	H406CS	0 – 6	3-5/8	6,600	3/4	5
20485	H408CS	0 – 8	4-1/2	6,900	3/4	8
20486	H410CS	2 – 10	5-3/8	8,000	7/8	12
20487	H412CS	2 – 12	5-3/4	9,500	7/8	15

# CLASSIC 400 SERIES™ COLUMBIAN ECONOMY C-CLAMPS

**SAFE AND ECONOMICAL**



**NOTE:**  
• COLUMBIAN C-Clamp meets federal spec # GGG-C-406D, Type I, Class A Light Service



**DROP FORGED  
CONSTRUCTION**



**OSCILLATING HEAD**



**BLACK OXIDE COATING**



# 4400 & 800 SERIES C-CLAMPS

**SQUARE THROAT AND STANDARD DEPTH**



**NOTE:**  
• 800 Series C-Clamp meets federal spec # GGG-C-406a, Type I, Class A, Grade a, Style 1



**PERMA-PADS®**

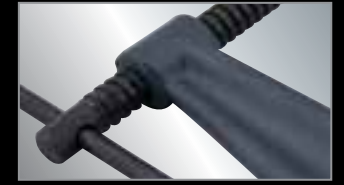

**BLACK OXIDE COATING**



**DROP FORGED  
CONSTRUCTION**



## FEATURES

### DROP FORGED:

- Manufactured for greater strength under regular strength applications

### BLACK OXIDE COATING:

- Spindles and pads are treated to resist corrosion

### PATENTED DESIGN:

- Frame geometry allows for maximum strength with greater throat depth and lower weight

## IDEAL FOR

- Steel Fabrication
- Industrial Maintenance
- Production
- Repair Operations

Stock No.	Model	Nominal Opening Capacity (in.)	Throat Depth (in.)	Clamping Force (lbs.)	Spindle Size (in.)	Net Weight (lbs.)
<b>400 SERIES COLUMBIAN</b>						
20301	H402	0 – 2	2	3,500	1/2	2
20302	H403	0 – 3	2-3/8	3,500	5/8	2
20303	H404	0 – 4	2-3/4	6,200	3/4	3
20304	H406	0 – 6	3-5/8	6,600	3/4	5
20305	H408	0 – 8	4-1/2	6,900	3/4	8
20306	H410	0 – 10	5-3/8	8,000	7/8	12
20307	H412	0 – 12	5-3/4	9,500	7/8	14

## FEATURES

### SQUARE THROAT DESIGN (4400 SERIES):

- Up to 37% more throat depth than standard deep throat C-Clamps

### PERMA-PADS®:

- Exclusive black oxide coated pad swivels and adapts to angular work pieces for tighter holding

### REPLACEABLE PARTS:

- Both the spindle and PERMA-PADS® are replaceable and can be individually ordered

### DROP FORGED:

- Manufactured for greater strength under regular strength applications

## IDEAL FOR

- Steel Fabrication
- Industrial Maintenance
- Production
- Repair Operations

Stock No.	Model	Nominal Opening Capacity (in.)	Throat Depth (in.)	Clamping Force (lbs.)	Spindle Size (in.)	Net Weight (lbs.)
<b>4400 SERIES SQUARE THROAT</b>						
14350	4404	0 – 4	4	4,100	3/4	5
14375	4406	0 – 6	5	5,400	3/4	6
14400	4408	2 – 8	6	5,900	3/4	10
<b>800 SERIES STANDARD DEPTH</b>						
14714	802	0-2	1-13/16	2,700	9/16	1
14728	803	0-3	1-15/16	3,000	9/16	2
14742	804	0-4	2-5/16	3,700	5/8	2
14756	806	0-6	2-15/16	4,500	5/8	4
14770	808	0-8	3-7/16	5,200	3/4	7
14784	810	1-1/2-10	3-3/4	6,000	3/4	8
14798	812	1-1/8-12	3-7/8	8,000	3/4	15



# 540A SERIES CARRIAGE C-CLAMPS

INDUSTRY'S CLASSIC DESIGN



OSCILLATING HEAD



SLIDING CROSS  
PIN HANDLE



DUCTILE IRON FRAMES



# 140 SERIES CARRIAGE C-CLAMPS

LIGHT INDUSTRIAL

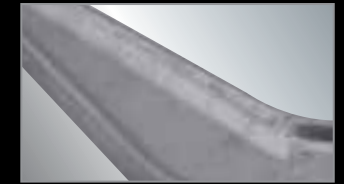

DUCTILE IRON FRAMES

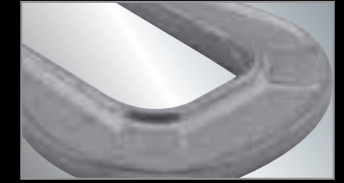

EXTRA DEEP REACH  
DESIGN



BLACK OXIDE COATING



## FEATURES

### DUCTILE IRON FRAMES:

- Rugged frames designed for maximum clamping pressure

### CLASSIC DESIGN:

- Most popular C-Clamp for over 50 years

### BLACK OXIDE COATING:

- Spindles and pads are treated to resist corrosion

### OSCILLATING HEAD:

- High quality steel pad is built to last and provide firm gripping action on angular surfaces

## IDEAL FOR

- Light Industrial
- Home Craftsman
- Woodworking
- Repair

Stock No.	Model	Nominal Opening Capacity (in.)	Throat Depth (in.)	Clamping Force (lbs.)	Spindle Size (in.)	Net Weight (lbs.)
<b>540 SERIES CARRIAGE</b>						
22001	540A-2-1/2	0 – 2-1/2	1-3/4	1,110	1/2	1
22002	540A-3	0 – 3	1-7/8	1,800	1/2	2
22003	540A-4	0 – 4	2-1/16	2,150	5/8	2
22004	540A-5	0 – 5	2-1/2	2,250	5/8	2
22005	540A-6	0 – 6	2-3/4	2,450	5/8	3
22006	540A-8	0 – 8	3-1/4	2,750	3/4	5
22007	540A-10	0 – 10	3-5/8	2,850	7/8	7
22008	540A-12	0 – 12	3-5/8	2,850	7/8	9
22009	540A-14	0 – 14	3-3/4	2,850	7/8	10

## FEATURES

### DEEP REACH PATTERN:

- Provided maximum depth for applications requiring increased throat capacity

### DUCTILE IRON FRAMES:

- Rugged frames designed for maximum clamping pressure

### BLACK OXIDE COATING:

- Spindle and pads are treated to resist corrosion

## IDEAL FOR

- Light Industrial
- Home Craftsman
- Woodworking
- Repair

Stock No.	Model	Nominal Opening Capacity (in.)	Throat Depth (in.)	Clamping Force (lbs.)	Spindle Size (in.)	Net Weight (lbs.)
<b>140 SERIES STANDARD CARRIAGE</b>						
41411	141C	0 – 1	1-1/16	645	1/4	1
41416	141-1/2C	0 – 1-1/2	1-1/2	820	5/16	1
41421	142C	0 – 2	1-1/8	800	5/16	1
41423	1422C	0 – 2-1/2	1-7/16	850	3/8	1
41426	142-1/2C	0 – 2-1/2	2-1/2	1,005	3/8	1
41405	143C	0 – 3	2	1,430	3/8	1
41406	144C	0 – 4	2-3/4	1,535	1/2	1
41407	145C	0 – 5	3	1,225	5/8	2
41408	146C	0 – 6	3-1/4	1,400	5/8	3
41409	148C	0 – 8	4	1,700	3/4	4
<b>DEEP REACH CARRIAGE</b>						
42510	251	0 – 1	3	350	1/4	1
42520	252	0 – 2	3-1/2	450	5/16	1
42525	252-1/2	0 – 2-1/2	4	600	3/8	1
42530	253	0 – 3	4-1/2	700	7/16	2
<b>XTRA DEEP REACH CARRIAGE</b>						
42450	245	2-1/2	4-3/4	1,600	7/16	2
42460	246	2-1/2	6-1/4	1,600	7/16	2

# JUNIOR® & SUPER JUNIOR® C-CLAMPS

**SUPER SMALL. SUPER TOUGH.**

566/588 JUNIOR



SUPER JUNIOR



ZINC PLATED SCREW

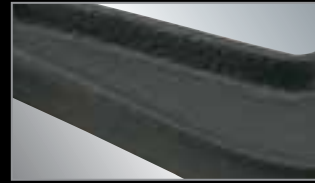

FORGED STEEL FRAMES



NYLON CAPS/FOOT INSERTS

# C-CLAMP REPLACEMENT PARTS



## FEATURES

### ZINC PLATED SCREW:

- Steel spindles are treated to resist corrosion extending life

### FORGED STEEL FRAMES:

- Heat treated to provide a strong weight to strength ratio

### NYLON CAPS / FOOT INSERTS (566/588 JUNIOR):

- Optional feature to protect the work surface from marring

### OSCILLATING HEAD:

- Firm gripping action on angular surfaces

## IDEAL FOR

- Light-Duty Clamping
- Aircraft/Aerospace Industry
- Pattern and Mold Making

Stock No.	Model	Nominal Opening Capacity (in.)	Throat Depth (in.)	Clamping Force (lbs.)	Spindle Size (in.)	Net Weight (lbs.)
<b>SUPER JUNIOR®</b>						
21301	50	0 – 1	1	500	1/4	1
21302	51	0 – 1	1-1/2	500	1/4	1
21303	52	0 – 1-1/4	1-1/4	800	1/4	1
21304	53	0 – 1-1/2	1-1/2	850	5/16	1
21305	54	0 – 2	1-1/4	875	5/16	1
21306	55	0 – 3	1-3/8	1,100	3/8	1
21307	56	0 – 2-1/2	2-1/2	850	3/8	1
<b>566/588 JUNIOR®</b>						
22105	H566	0 – 1-1/4	1-1/4	450	1/4	1
22115	H566N	0 – 1-1/4	1-3/16	550	1/4	1
22116	H568N	0 – 2-1/2	2-5/16	550	3/4	1

Stock No.	Model	Spindle Assembly Stock No.	Perma-Pad® with Ring Stock No.
<b>BRUTE FORCE 0-SERIES</b>			
14518	1 F.C.	20203-35	N/A
14527	1-1/2 F.C.	20203-35	N/A
14536	2 F.C.	07142-35	N/A
14545	3 F.C.	07161-35	N/A
14554	4 F.C.	07147-35	N/A
14563	5 F.C.	07162-35	N/A
14572	6 F.C.	07149-35	N/A
14581	8 F.C.	07150-35	N/A
14590	10 F.C.	07151-35	N/A
14599	12 F.C.	07152-35	N/A
<b>BRUTE FORCE 100 SERIES</b>			
14114	102	1700010	2901300
14128	103	1700020	2901300
14142	104	1700030	2901310-1
14156	106	1700030	2901310-1
14170	108	1700030	2901310-1
14184	110	1700030	2901310-1
14198	112	1700030	2901310-1
<b>CLASSIC 400 SERIES</b>			
14214	402	1701080	2901300
14228	403	1701160	2901300
14242	404	1700150	2901310
14256	406	1700170	2901310
14270	408	1700190	2901310
14284	410	1700190	2901310
14298	412	1700220	2901310

Stock No.	Model	Spindle Assembly Stock No.	Perma-Pad® with Ring Stock No.
<b>CLASSIC 400 SERIES HI-VIS SAFETY</b>			
14300	402-SF	1701080	2901300
14301	403-SF	1701160	2901300
14302	404-SF	1700150	2901310
14303	406-SF	1700170	2901310
14305	408-SF	1700190	2901310
14306	410-SF	1700190	2901310
14307	412-SF	1700220	2901310
<b>SPARK-DUTY 400P</b>			
14215	402-P	1701090	2901330
14229	403-P	1701110	2901330
14243	404-P	1700160	2901340
14257	406-P	1700180	2901340
14271	408-P	1700210	2901340
14285	410-P	1700210	2901340
14299	412-P	1700230	2901340
<b>SPARK-DUTY 400CS HI-VIS SAFETY</b>			
20479	H402CS	1701090	2901330
20481	H403CS	1701110	2901330
20483	H404CS	1700160	2901340
20484	H406CS	1700180	2901340
20485	H408CS	1700210	2901340
20486	H410CS	1700210	2901340
20487	H412CS	1700230	2901340

Stock No.	Model	Spindle Assembly Stock No.	Perma-Pad® with Ring Stock No.
<b>4400 SERIES DEEP THROAT</b>			
14350	4404	1700150	2901310
14375	4406	1700170	2901310
14400	4408	1700170	2901310
<b>800 SERIES STANDARD DEPTH</b>			
14714	802	1701080	2907920
14728	803	1701160	2907920
14742	804	1700750	2901320
14756	806	1700740	2901320
14770	808	1700190	2907930
14784	810	1700190	2907930
14798	812	1700630	2907930



# ANGLE CLAMPS

## 90° CLAMPING

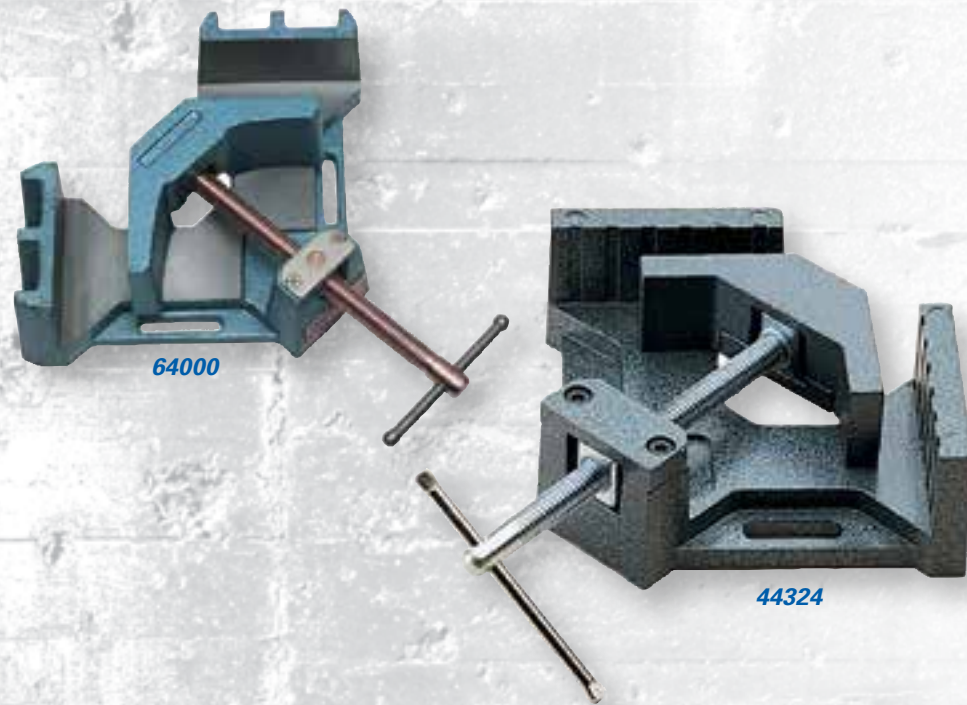

SELF CENTERING JAW



VERSATILE MOUNTING SLOTS



COPPER PLATED SPINDLE  
(64000 & 64002 ONLY)

## FEATURES

### HEAVY DUTY FRAME:

- The 90° angle clamp is made of high-quality cast iron (SKUs 64000 and 64002) or solid aluminum construction (SKU 44324)

### VERSATILE MOUNTING SLOTS:

- Slotted holes are provided in the base for convenient workbench mounting

### PRECISION:

- Work surfaces (including base) are milled for added precision

## IDEAL FOR

- Welding
- Woodworking
- Light Industrial

Stock No.	Model	Capacity Miter (in.)	Jaw Height (in.)	Jaw Length (in.)	Net Weight (lbs.)
<b>HEAVY-DUTY STEEL ANGLE CLAMPS</b>					
64000	AC-325	3-11/32	1-3/8	4-1/8	11
64002	AC-326	4-3/8	2-3/8	4-1/8	21
<b>REGULAR-DUTY ALUMINUM ANGLE CLAMP</b>					
44324	AC-324	2-3/4	1-3/8	2-1/4	3

# SPECIALTY CLAMPS



## EXTRA DEEP STEEL PIPE CLAMP

- Ideal for any applications where extra deep-reach is required
- Moveable and stationary parts are made of heavy-duty, ductile cast iron for added strength
- Multiple disc clutch provides sliding jaws with instant adjustment, secure hold and quick release
- 2-Piece design universal fit for any 3/4" pipe

## REGULAR-DUTY I BAR CLAMPS

- A rapid acting powerful clamp designed and constructed for hard, everyday production work
- Patented, quick action, no slip clutches are 3/4" apart and formed in the web for greater bar strength
- High strength ductile slide cannot slip or bind, easily released
- Steel handle, with comfortable wood crank handle for fast clamping
- Bar dimension is 7/16" x 1-1/2" x 5/32", screw diameter is 5/8"

Stock No.	Pipe Size (in.)	Clamp Face (in.)	Net Weight (lbs.)
<b>EXTRA DEEP PIPE CLAMP</b>			
14870	3/4	2 x 1-3/4	8

Stock No.	Bar Length (ft.)	Throat Depth (in.)	Clamp Face (in.)	Clamping Force (lbs.)	Net Weight (lbs.)
<b>I BAR CLAMPS</b>					
21801	2	1-13/16	1-7/8	6,000	8
21803	3	1-13/16	1-7/8	6,000	8
21804	4	1-13/16	1-7/8	6,000	10
21805	5	1-13/16	1-7/8	6,000	13
21806	6	1-13/16	1-7/8	6,000	14





# WILTON B.A.S.H.<sup>®</sup>

**THE WORLD'S MOST DURABLE STRIKING TOOLS**

At Wilton<sup>®</sup>, we are on a never-ending journey to create the highest quality, most indestructible tools on the market. On this journey we've managed to design patents for the world's most durable hammers with Unbreakable<sup>®</sup> Handle Technology, revolutionary design, and engineered no-slip rubber grip.



**WILTON B.A.S.H.<sup>®</sup>  
SLEDGE HAMMERS**



**WILTON B.A.S.H.<sup>®</sup>  
BRASS HAMMERS**



**WILTON B.A.S.H.<sup>®</sup>  
BALL & CROSS PEIN**

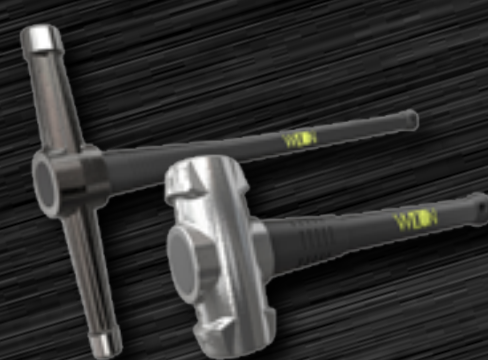

**WILTON B.A.S.H.<sup>®</sup>  
GRADE B SLEDGE  
HAMMERS & SPIKE MAUL**



**WILTON B.A.S.H.<sup>®</sup>  
SPIKE & SPLITTING  
MAULS**



**WILTON B.A.S.H.<sup>®</sup>  
DEAD BLOW  
HAMMERS**

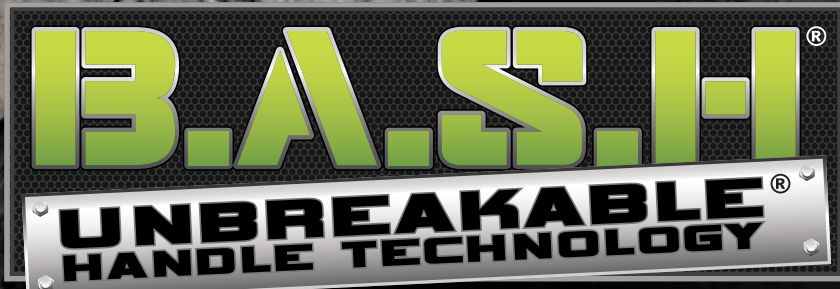

# BAD ASS... & WE'LL PROVE IT

400% TOUGHER...

STRIKE AFTER STRIKE THE RESULTS SPEAK FOR THEMSELVES

## THE WORLD'S MOST DURABLE STRIKING TOOLS

- A: UNBREAKABLE® HANDLE TECHNOLOGY**  
STEEL CORE DESIGN PREVENTS BREAKING DURING OVERSTRIKES
- B: SAFETY PLATE**  
LOCKS HEAD FIRMLY TO HANDLE ELIMINATING DISLODGING
- C: NO-SLIP GRIP**  
TEXTURED HANDLE FOR SECURE GRIP WHILE STRIKING
- D: TRADEMARK GREEN HEAD**  
HI-VIS, DROP FORGED 46 HRC HEAD ENDURES THE MOST DEMANDING APPLICATIONS AND ADDS INSTANT IDENTIFICATION



### OVERSTRIKE TEST\*

Number of mechanical overstrikes before handle breaks



**FLAT HEAD**  
CONVENIENTLY DESIGNED TO STAND UPRIGHT FOR EASY REACH



**ANTI-VIBE NECK**  
ERGONOMICALLY DESIGNED TO PREVENT INJURY FROM REPEATED JOB SITE USE



**LANYARD HOLE**  
SAFELY SECURE SLEDGE HAMMER TO YOUR WRIST

\* Results based on independent laboratory testing. Chart is for visual representation only.

# B.A.S.H.<sup>®</sup> SLEDGE HAMMERS

THE WORLD'S MOST DURABLE SLEDGE HAMMER



B.A.S.H.<sup>®</sup> SLEDGE HAMMER



B.A.S.H.<sup>®</sup> SOFT FACE



UNBREAKABLE<sup>®</sup>  
HANDLE TECHNOLOGY



SAFETY PLATE



ANTI-VIBE NECK

## DURABILITY & SAFETY FEATURES

### UNBREAKABLE<sup>®</sup> HANDLE TECHNOLOGY:

- Steel core eliminates breaking during overstrikes

### TRADEMARK GREEN HEAD :

- Patented hi-vis drop forged 46 HRC head endures the most demanding applications

### SAFETY PLATE:

- Secures head to handle preventing head from dislodging

### ANTI-VIBE NECK:

- Thick, tapered neck absorbs vibration reducing worker fatigue

### NO-SLIP GRIP:

- Vulcanized rubber handle for secure grip while striking

### LANYARD HOLE:

- Safely secure hammer to wrist or stationary object

Stock No.	Head Size (lbs.)	Handle Size (in.)	Net Weight (lbs.)
<b>B.A.S.H.<sup>®</sup> SLEDGE HAMMERS (46 HRC)</b>			
20212	2-1/2	12	4
20412	4	12	5
20416	4	16	6
20424	4	24	6
20616	6	16	8
20624	6	24	9
20630	6	30	10
20636	6	36	11
20816	8	16	11
20824	8	24	11
20830	8	30	12
20836	8	36	13

Stock No.	Head Size (lbs.)	Handle Size (in.)	Net Weight (lbs.)
<b>B.A.S.H.<sup>®</sup> SLEDGE HAMMERS (46 HRC)</b>			
21016	10	16	13
21024	10	24	13
21030	10	30	15
21036	10	36	15
21224	12	24	16
21230	12	30	17
21236	12	36	18
21424	14	24	18
21430	14	30	19
21436	14	36	20
22024	20	24	24
22030	20	30	25
22036	20	36	27

Stock No.	Head Size (lbs.)	Handle Size (in.)	Net Weight (lbs.)
<b>B.A.S.H.<sup>®</sup> SOFT FACE SLEDGE HAMMERS (30 HRC)</b>			
40212	2-1/2	12	4
40412	4	12	5
40416	4	16	6
40624	6	24	9
40636	6	36	11
40824	8	24	11
40836	8	36	11
41036	10	36	15
41236	12	36	18
41436	14	36	20

## IDEAL FOR

- Demolition Work
- Fracturing Stone and Concrete

- Driving Fence Posts
- Police, Fire & Rescue

## IDEAL FOR

- Maintenance on hard metal surfaces
- Mining
- Cutting Tools



# B.A.S.H.<sup>®</sup> GRADE B SLEDGE HAMMERS & SPIKE MAUL

THE WORLD'S MOST DURABLE SLEDGE HAMMER



**GRADE B  
ALLOY**

## GRADE B SPECIFICATIONS

- Sledge Hammers and Spike Maul designed in-line with AREMA plan 13-08 and 3-08 respectively
- Extending the life of the tool, Grade B striking tools use harder alloy (51-55 HRC) and receive a deeper heat treatment permitting heads to be redressed.
- Manufactured with production with date codes on both the head and the handle in accordance with AREMA standards.
- More contoured striking face reduces material chip off.

## IDEAL FOR

- Removing & Installing Rail Anchors
- Driving Railroad Spikes
- Performing Railway Maintenance



**UNBREAKABLE<sup>®</sup>  
HANDLE TECHNOLOGY**



**SAFETY PLATE**



**ANTI-VIBE NECK**

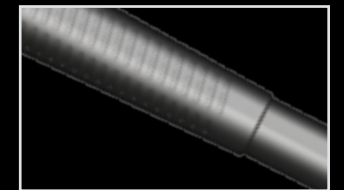

**NO-SLIP GRIP**

Stock No.	Head Size (lbs.)	Handle Size (in.)	Net Weight (lbs.)
<b>B.A.S.H.<sup>®</sup> GRADE B SLEDGE HAMMERS (51-55 HRC)</b>			
20212B	2-1/2	12	4
20416B	4	16	6
20630B	6	30	10
20830B	8	30	12
21036B	10	36	15
21236B	12	36	18
<b>B.A.S.H.<sup>®</sup> GRADE B SPIKE MAUL (51-55 HRC)</b>			
31036B	10	36	14



# B.A.S.H.<sup>®</sup> BRASS SLEDGE HAMMERS

THE WORLD'S MOST DURABLE



UNBREAKABLE<sup>®</sup>  
HANDLE TECHNOLOGY



SAFETY PLATE



ANTI-VIBE NECK



NON-SPARKING  
BRASS HEAD

# B.A.S.H.<sup>®</sup> BALL & CROSS PEIN HAMMERS

THE WORLD'S MOST DURABLE



BALL PEIN

CROSS PEIN



UNBREAKABLE<sup>®</sup>  
HANDLE TECHNOLOGY



SAFETY PLATE



ANTI-VIBE NECK

## DURABILITY & SAFETY FEATURES

### UNBREAKABLE<sup>®</sup> HANDLE TECHNOLOGY:

- Steel core eliminates breaking during overstrikes

### BRASS HEAD :

- Non-sparking for use near combustible materials and non-marring to reduce work damage

### SAFETY PLATE:

- Secures head to handle preventing head from dislodging

### ANTI-VIBE NECK:

- Thick, tapered neck absorbs vibration reducing worker fatigue

### NO-SLIP GRIP:

- Vulcanized rubber handle for secure grip while striking

### LANYARD HOLE:

- Safely secure hammer to wrist or stationary object

Stock No.	Head Size (lbs.)	Handle Size (in.)	Net Weight (lbs.)
<b>B.A.S.H.<sup>®</sup> BRASS SLEDGE HAMMERS</b>			
90212	2.5	12	4
90412	4	12	5
90416	4	16	6
90616	6	16	8
90816	8	16	10
90830	8	30	12

## IDEAL FOR

- Use near combustible materials
- Where surface protection is required
- Oil & gas
- Mining
- Aerospace



HOLDING STRONG SINCE 1941

## DURABILITY & SAFETY FEATURES

### UNBREAKABLE<sup>®</sup> HANDLE TECHNOLOGY:

- Steel core eliminates breaking during overstrikes

### SAFETY PLATE:

- Secures head to handle preventing head from dislodging

### ANTI-VIBE NECK:

- Thick, tapered neck absorbs vibration reducing worker fatigue

### NO-SLIP GRIP:

- Vulcanized rubber handle for secure grip while striking

### TRADEMARK GREEN HEAD:

- Patented hi-vis drop forged 46 HRC head endures the most demanding applications

### LANYARD HOLE:

- Safely secure hammer to wrist or stationary object

## IDEAL FOR

- Light Forging
- Bending
- Forming
- Peining



WILTONTOOLS.COM



# B.A.S.H.<sup>®</sup> DEAD BLOW HAMMERS

THE WORLD'S MOST DURABLE



DEAD BLOW



SOFT FACE



SPARK-RESISTANT

# B.A.S.H.<sup>®</sup> SPIKE & SPLITTING MAULS

THE WORLD'S MOST DURABLE



UNBREAKABLE<sup>®</sup> HANDLE TECHNOLOGY



SAFETY PLATE

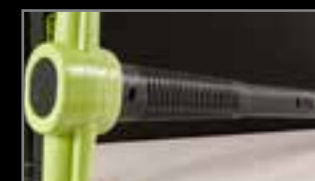

ANTI-VIBE NECK

## DURABILITY & SAFETY FEATURES

### DEAD BLOW:

- Eliminates bounce back when striking hardened surfaces

### SPARK-RESISTANT:

- Safe for use near combustible materials - no exposed metal on face, head or shaft

### SOFT FACE:

- Helps prevent marring

### UNBREAKABLE<sup>®</sup> HANDLE TECHNOLOGY:

- Steel core eliminates breaking during overstrikes

### ERGONOMIC HANDLE:

- Shaped and thickened for improved comfort and less vibration

### NO-SLIP GRIP:

- Vulcanized rubber handle for secure grip while striking

### LANYARD HOLE:

- Safely secure hammer to wrist or stationary object

Stock No.	Hammer Weight (lbs.)	Handle Size (in.)
<b>B.A.S.H.<sup>®</sup> DEAD BLOW HAMMERS</b>		
55114	1-1/2	14
55214	2	14
55314	3	14
55416	4	16
55830	8	30



## IDEAL FOR

- Automotive
- Metal Fabrication
- Oil and Mining
- Wood and Metal Assembly
- Aerospace Industry

## DURABILITY & SAFETY FEATURES

### UNBREAKABLE<sup>®</sup> HANDLE TECHNOLOGY:

- Steel core eliminates breaking during overstrikes

### SAFETY PLATE:

- Secures head to handle preventing head from dislodging

### ANTI-VIBE NECK:

- Thick, tapered neck absorbs vibration reducing worker fatigue

### NO-SLIP GRIP:

- Vulcanized rubber handle for secure grip while striking

### TRADEMARK GREEN HEAD:

- Patented hi-vis drop forged 46 HRC head endures the most demanding applications

### LANYARD HOLE:

- Safely secure hammer to wrist or stationary object

Stock No.	Head Size (lbs.)	Handle Size (in.)	Net Weight (lbs.)
<b>B.A.S.H.<sup>®</sup> SPIKE MAUL</b>			
31036	10	36	14
<b>B.A.S.H.<sup>®</sup> SPLITTING MAUL</b>			
50630	6	30	9
50636	6	36	10
50830	8	30	11
50836	8	36	11



## IDEAL FOR

- Driving Railroad Spikes (*Spike Maul*)
- Splitting Wood (*Splitting Maul*)
- Striking Wedges (*Splitting Maul*)

# B.A.S.H.<sup>®</sup> 3 PC HAMMER KIT

THE WORLD'S MOST DURABLE



# DUCTILE IRON & ALUMINUM PIPE WRENCHES

HEAVY-DUTY AND BUILT TO LAST



DROP FORGED JAWS



DUCTILE CAST IRON  
HANDLE



HEAVY-DUTY  
ADJUSTABLE RING



LIGHTWEIGHT  
ALUMINUM BODY

## DURABILITY & SAFETY FEATURES

### UNBREAKABLE<sup>®</sup> HANDLE TECHNOLOGY:

- Steel core eliminates breaking during overstrikes

### SAFETY PLATE:

- Secures head to handle preventing head from dislodging

### ANTI-VIBE NECK:

- Thick, tapered neck absorbs vibration reducing worker fatigue

### NO-SLIP GRIP:

- Vulcanized rubber handle for secure grip while striking

### TRADEMARK GREEN HEAD:

- Patented hi-vis drop forged 46 HRC head endures the most demanding applications

### LANYARD HOLE:

- Safely secure hammer to wrist or stationary object

Stock No.	Qty.	Description
<b>B.A.S.H.<sup>®</sup> 3-Piece Hammer Kit 3PCBASH</b>		
20212	1	2-1/2 Lb. Head, 12" Handle Hammer
32414	1	24 Oz. Head, 14" Handle Ball Pein Hammer
30216	1	2 Lb. Head, 16" Handle Cross Pein Hammer
-	1	Protective Carrying Case

## DUCTILE FEATURES

### JAW CONSTRUCTION

- Drop forged upper and lower jaws

### JAW TYPE:

- Floating hook jaw with spring suspension for easier gripping

### RING AND HANDLE:

- Heavy-Duty adjustable ring and ductile cast iron handle

### CAPACITY:

- 1.5" to 5"

Stock No.	Description	Pipe Capacity (in.)	Net Weight (lbs.)
<b>WILTON<sup>®</sup> DUCTILE IRON PIPE WRENCHES</b>			
38110	10" Ductile Pipe Wrench	1-1/2	2
38114	14" Ductile Pipe Wrench	2	4
38118	18" Ductile Pipe Wrench	2-1/2	6
38124	24" Ductile Pipe Wrench	3	9
38136	36" Ductile Pipe Wrench	5	21

## ALUMINUM FEATURES

### HANDLE CONSTRUCTION

- High quality cast aluminum body

### JAWS:

- Drop forged upper and lower jaws

### ADJUSTING RING

- Heavy-Duty adjustable ring

### CAPACITY:

- 1.5" to 5"

Stock No.	Description	Pipe Capacity (in.)	Net Weight (lbs.)
<b>WILTON<sup>®</sup> ALUMINUM PIPE WRENCHES</b>			
38210	10" Aluminum Pipe Wrench	1-1/2	1
38214	14" Aluminum Pipe Wrench	2	2
38218	18" Aluminum Pipe Wrench	2-1/2	4
38224	24" Aluminum Pipe Wrench	3	6
38236	36" Aluminum Pipe Wrench	5	11



**HOLDING STRONG SINCE 1941**

**WILTONTOOLS.COM**