

### 20645

(201-990-00-50)  
Black Nylon

Rear Compartment  
Carpet Retainer  
Stud Size: 5mm  
Head Diameter: 24mm  
Hex: 10mm

UNIT PACKAGE: 25



### 21431

(BMW: 16-13-1-176-747;  
Mercedes-Benz: 003-990-02-51)  
Black Nylon

Nylon Flange Nut  
Stud Size: 5mm  
Flange Diameter: 16mm  
Hex: 10mm  
Overall Height: 11mm  
BMW & Mercedes-Benz 1997 - On

UNIT PACKAGE: 25



### 20653

Gray Nylon

Wire Routing Clip  
Inside Diameter: 7mm x 10mm  
Fits into 6mm Hole  
BMW & Mercedes

UNIT PACKAGE: 50



### 20654

(001-997-42-90)  
Black Nylon

*Photo not actual size*  
Cable Strap  
Length: 120mm (4-3/4")  
Fits into 8mm Hole

UNIT PACKAGE: 10

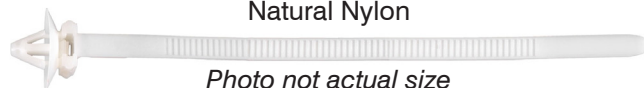

### 21305

(Not Available from O.E.M.)  
Natural Nylon

*Photo not actual size*  
Push-Mount Cable Strap  
Strap Width: 5mm (3/16")  
Length: 156mm (6-1/8")  
Snaps into 6.3mm (1/4") Hole  
Maximum Bundle Diameter: 40mm (1-9/16")  
European Makes & Universal

UNIT PACKAGE: 25



### 20655

(114-997-02-90)  
Black Nylon

*Photo not actual size*  
Cable Strap  
Length: 160mm (6-3/8")  
Fits into 8mm Hole

UNIT PACKAGE: 10



### 21823

(Mercedes-Benz: 001-994-98-45)  
Zinc

Shield Clip Nut  
Screw Size: M4.8-1.61 (#10)  
Head Size: 10mm x 19mm  
Overall Height: 7.5mm  
Mercedes-Benz 2002 - On

UNIT PACKAGE: 25



### 22115

(Mercedes: 124-988-90-78-M89)  
Zinc

Bumper Moulding Clip  
Width: 16mm  
Length: 19mm  
Overall Height: 9mm  
Mercedes

UNIT PACKAGE: 25

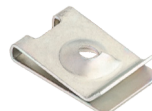

### 20649

Screw Size: M3.5 (#6)  
Panel Range: .5mm - 1.5mm  
Center of Hole to Edge: 8mm

UNIT PACKAGE: 50



### 13223

(BMW: 0712-9-925-708;  
Mercedes: 000-994-25-45)  
Plated

U-Type Nut  
Screw Size: 4.2mm (#8)  
Panel Range: 3mm-4mm  
Center of Hole to Edge: 7mm

UNIT PACKAGE: 50



### 13224

(000-994-04-45)  
Plated

U-Type Nut  
Screw Size: 4.2mm (#8)  
Panel Range: .5mm-1.7mm  
Center of Hole to Edge: 8mm

UNIT PACKAGE: 50

**MERCEDES-BENZ AND MINI-COOPER  
CLIPS & FASTENERS**



**20650**  
(123-994-08-45)  
Zinc

Screw Size: M4.2 (#8)  
Panel Range: .5mm - 2.5mm  
Center of Hole to Edge: 14mm

UNIT PACKAGE: 25



**13216**  
Zinc

U-Type Nut  
Screw Size: 4.8mm  
Panel Range: .9mm-2.0mm  
Center of Hole to Edge: 8mm

UNIT PACKAGE: 25



**13218**  
(BMW: 0712-9-925-737;  
Mercedes 000-994-06-45)  
Plated

U-Type Nut  
Screw Size: 4.8mm  
Panel Range: .5mm-1.7mm  
Center of Hole to Edge: 7mm

UNIT PACKAGE: 50



**13220**  
(Mercedes: 000-994-09-45;  
Volvo: 946-418; Opel: 20-72-175)  
Plated

U-Type Nut  
Screw Size: 6.3mm  
Panel Range: .7mm-1.5mm  
Center of Hole to Edge: 13mm

UNIT PACKAGE: 50



**13215**  
(BMW: 0711-9-916-945,  
Mercedes 000-994-14-45)  
Plated

U-Type Nut  
Screw Size: 4.8mm  
Panel Range: .8mm-1.7mm  
Center of Hole to Edge: 11mm

UNIT PACKAGE: 50



**20651**  
(001-990-00-91)  
Zinc

Screw Size: M6 - 1.0  
Panel Range: .5mm - 1.7mm  
Center of Hole to Edge: 15mm

UNIT PACKAGE: 10

**MINI-COOPER CLIPS & FASTENERS**



**21659**  
(07-13-2-757-821)  
Gray Nylon

Moulding Clip  
Top Head Size: 11mm x 19mm  
Bottom Head Diameter: 21mm  
Stem Length: 11mm  
Mini-Cooper 2002 - On

UNIT PACKAGE: 15



**21709**  
(Mini-Cooper: 07-13-1-480-419)  
Black Nylon

Rocker Panel Moulding Clip  
Top Head Size: 16mm x 20mm  
Middle Head Diameter: 18mm  
Bottom Head Diameter: 23mm  
Stem Length: 19mm  
Mini-Cooper 2002 - On

UNIT PACKAGE: 15



**21527**  
(07-13-7-073-915)  
White Nylon

Trim Panel & Fender Flare Moulding Clip  
Top Head Size: 11.5mm x 19mm  
Bottom Head Diameter: 21mm  
Stem Length: 13mm  
Fits into 8mm Hole  
Mini Cooper S 2002 - On

UNIT PACKAGE: 15



**21716**  
(Mini-Cooper: 51-71-7-127-742)  
Red Nylon

Moulding Clip  
Top Head Size: 16mm x 20mm  
Middle Head Diameter: 18mm  
Bottom Head Diameter: 23mm  
Stem Length: 21mm  
Overall Length: 29mm  
R58, R59 & S 2009 - On

UNIT PACKAGE: 15



### 21143

(51-71-1-496-621)  
Black Nylon

Rocker Moulding Retainer  
Head Size: 8.5mm x 14mm  
Stem Size: 5mm x 7.5mm  
Stem Length: 14mm  
Mini Cooper 2002 - On

UNIT PACKAGE: 25



### 21137

(07-13-0-702-516)  
Black Nylon

Rear Quarter Wheel Opening  
Moulding Retaining Clip  
Top Head Diameter: 13mm  
Middle Head Diameter: 15mm  
Bottom Head Diameter: 15mm  
Stem Diameter: 10mm  
Stem Length: 8mm  
Fits into 8mm Hole  
Mini Cooper 2002 - On

UNIT PACKAGE: 25



### 21787

(BMW: 51-77-7-171-002)  
White Nylon

Wheel Arch Cover & Footboard  
Retainer with Sealer  
Top Head Diameter: 12mm  
Bottom Head Diameter: 18mm  
Stem Diameter: 9.5mm  
Stem Length: 16mm  
Mini-Cooper S & SX Series 2011 - On  
BMW X Series 2006 - On

UNIT PACKAGE: 25



### 21139

(07-14-7-145-753)  
White Nylon

Body Side Moulding Retainer with Sealer  
Top Head Diameter: 12mm  
Middle Head Diameter: 15mm  
Bottom Head Diameter: 18mm  
Stem Diameter: 9.5mm  
Stem Length: 11mm  
Mini Cooper 2002 - On

UNIT PACKAGE: 25



### 21138

(51-43-7-001-491-2)  
White Nylon

Headliner Retainer  
Top Head Diameter: 14mm  
Middle Head Diameter: 15mm  
Bottom Head Diameter: 18mm  
Stem Diameter: 9mm  
Stem Length: 14mm  
Mini Cooper 2005 - On

UNIT PACKAGE: 25



### 21788

(BMW: 51-41-8-224-768, 51-41-0-407-984)  
White Nylon

Door Panel Lining & Rear Window  
Retainer with Sealer  
Top Head Diameter: 14mm  
Middle Head Diameter: 15.5mm  
Bottom Head Diameter: 18mm  
Stem Diameter: 9.5mm  
Stem Length: 14mm  
Mini-Cooper 2002 - On  
BMW X Series 2006 - On

UNIT PACKAGE: 25



### 22285

(Mini-Cooper: 07-14-6-962-771)  
Red Nylon

Rocker Moulding &  
Pillar Retainer with Sealer  
Top Head Diameter: 14.3mm  
Middle Head Diameter: 15.5mm  
Bottom Head Diameter: 18mm  
Stem Diameter: 9.5mm  
Stem Length: 13mm  
Overall Length: 19mm  
Mini-Cooper 2006 - On

UNIT PACKAGE: 15



### 22303

(BMW: 51-16-8-197-908)  
Black Nylon

Upper Cover & Spoiler  
Push-Type Retainer  
Head Diameter: 12mm  
Stem Length: 13mm  
Fits into 7mm Hole

BMW 1, 3, M3 & Z4 and Mini-Cooper Base, John  
Cooper Works, Countryman & Paceman 2013 - On

UNIT PACKAGE: 15



### 20570

(Mini-Cooper: 07-13-0-702-715;  
Honda: 75307-SN7-000)

Wheel Opening Nylon Moulding Nut  
With Brass Insert  
Thread: M4-0.7  
Flange Outer Diameter: 12mm  
Hex: 10mm  
Height: 11mm

UNIT PACKAGE: 15

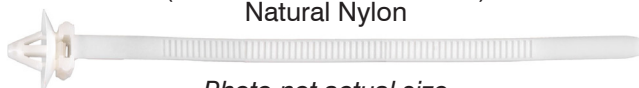

### 21305

(Not Available from O.E.M.)  
Natural Nylon

*Photo not actual size*  
Push-Mount Cable Strap  
Length: 156mm (6-1/8")  
Strap Width: 5mm (3/16")  
Snaps into 6.3mm (1/4") Hole  
Maximum Bundle Diameter: 40mm (1-9/16")  
European Makes & Universal

UNIT PACKAGE: 25



**19343**  
(MB608137)  
Natural Nylon

Windshield Moulding Clip  
Diamante 1995-91

UNIT PACKAGE: 15



**19745**  
(MB880455)  
Light Blue Nylon

Windshield Moulding Clip  
Montero 1992-On

UNIT PACKAGE: 10

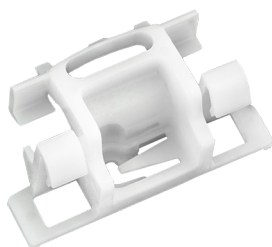

**19314**  
(MB814419)  
Nylon

Drip Moulding & Garnish  
Moulding Clip  
Galant 1993-On

UNIT PACKAGE: 25



**17195**  
Black Nylon

Grille Clip  
Width: 13mm  
Length: 22mm  
Ford Escort, Honda, Isuzu,  
Mitsubishi & Plymouth Laser

UNIT PACKAGE: 25



**21623**  
(Mitsubishi: MR221507;  
Toyota: 90467-13075)  
Gray Nylon

Radiator Grille Clip  
Width: 14mm  
Length: 24mm  
Mitsubishi Diamante, Endeavor & Galant 1997 - On  
Toyota 4 Runner, Highlander & Land Cruiser 1998 - On

UNIT PACKAGE: 25



**20572**  
(MB846992)  
White Nylon

Rocker Panel Retainer  
Top Head Diameter: 12mm  
Bottom Head Diameter: 16mm  
Stem Length: 14mm  
Fits into 7mm Hole  
Montero 2001 - On

UNIT PACKAGE: 10



**19330**  
(MB608140)  
White Nylon

Trunk Air Dam  
Side Moulding Clip  
Diamante 1991-On

UNIT PACKAGE: 10



**21863**  
(Hyundai: 87758-35010)  
White Nylon

Moulding Clip with Sealer  
Top Head Size: 10mm x 12mm  
Bottom Head Size: 14mm x 18mm  
Stem Length: 10mm  
Hyundai Accent, Kia Soul &  
Mitsubishi Outlander 2006 - On

UNIT PACKAGE: 15



**21632**  
(MU480001)  
Natural Nylon

Screw Size: M3.5(#6)  
Head Size: 10mm x 10mm  
Stem Length: 7mm  
Fits into 6mm x 6mm Hole  
Mitsubishi Eclipse and Chrysler  
Avenger, Colt, Jeep Eagle Talon,  
Laser & Sebring 2000 - 1984

UNIT PACKAGE: 50



**14255**  
(Mitsubishi: MS-480001;  
Honda: 75522-611-000;  
Mazda: 9991-00-412)  
Black Nylon

Screw Size: #8  
Width: 9.5mm  
Length: 9.5mm  
Snaps into 7mm x 7mm Hole

UNIT PACKAGE: 50



**19487**  
(MB419858)  
Natural Nylon

Scuff Plate Screw Grommet  
Screw Size: #6  
Diamante 1995-91

UNIT PACKAGE: 15





### 13932

(Mitsubishi: MS-480002;  
Toyota: 90189-05013)  
Natural Nylon

Screw Size: #10  
Width: 12mm  
Length: 12mm  
Fits into 8mm x 9mm Hole

UNIT PACKAGE: 50



### 19485

Natural Nylon

Screw Size: #14 (M6.3)  
Fits into 3/8" x 3/8" Hole  
Eclipse

UNIT PACKAGE: 10



### 20573

(MB817060)  
White Nylon

Headliner Nylon Nut  
Head Diameter: 15mm  
Inside Diameter: 6mm  
Stem Length: 11mm  
Fits into 9mm Hole  
Montero 1997 - On

UNIT PACKAGE: 15



### 14335

(Mitsubishi: MB-106212;  
Nissan: 96706-H9400, -K1300, -K1351)  
Natural Nylon

Screw Grommet  
Screw Size: #8  
Head Diameter: 13.5mm  
Stem Length: 16mm  
Fits into 6mm x 6mm Hole

UNIT PACKAGE: 50



### 14695

(Mitsubishi: MS-480012;  
Honda: 90661-SC7-003;  
Mazda: H001-50-841;  
Nissan: 01651-00481, 74798-S9000;  
Toyota: 90189-06042)  
White Nylon

Screw Grommet  
Screw Size: #8  
Head Diameter: 16mm  
Stem Length: 17mm  
Fits into 8mm x 8mm Hole

UNIT PACKAGE: 25



### 19322

(MU480034)  
Natural Nylon

Rear Side & Trunk Trim  
Screw Grommet  
Screw Size: #8  
Eclipse 1994-On

UNIT PACKAGE: 15



### 14275

(Mitsubishi: MB-098145;  
Nissan: 01281-00023, 01281-00231;  
Toyota: 90189-06001)  
White Nylon

Screw Grommet  
Screw Size: #10  
Head Diameter: 18mm  
Stem Length: 17mm  
Fits into 8.5mm x 8.5mm Hole

UNIT PACKAGE: 25



### 20581

(MR478263)  
Black Rubber

Bumper Cover & Garnish  
Moulding Grommet with Sealer  
Head Diameter: 16mm  
Stem Length: 20mm  
Fits into 9mm Hole

**Use with Auveco 20580**  
Chrysler Sebring & Stratus  
and Mitsubishi Eclipse 2000 - On

UNIT PACKAGE: 15



### 20565

(MB271999)  
Black Nylon

Bumper Cover Grommet  
Head Diameter: 24mm  
Stem Length: 21mm  
Fits into 13mm Hole  
Chrysler Colt, Eagle, Sebring & Stratus 1989 - On  
Mitsubishi Eclipse, Galant & Mirage 1993 - On

UNIT PACKAGE: 10



### 19324

(MB888561)  
Natural Nylon

Drip Moulding Screw Grommet  
Screw Size: #8  
Eclipse 1994-On

UNIT PACKAGE: 25



**21025**  
(MB645307)  
Black Nylon

Back Glass Lower Moulding,  
Quarter Glass Moulding &  
Spoiler Grommet with Sealer  
Head Size: 12mm x 16mm  
Stem Length: 14mm  
Dodge Avenger & Stealth and  
Chrysler Sebring 1991 - On  
Mitsubishi 1991 - On

UNIT PACKAGE: 15



**19331**  
(MB869072)  
Black Nylon

Headliner & Trunk Trim  
Retaining Clip  
Head Diameter: 14mm  
Stem Length: 11mm  
Fits into 7mm Hole  
Diamante 1995-91

UNIT PACKAGE: 15



**20381**  
(Honda: 90667-671-013ZA;  
Mitsubishi: MC440901;  
Nissan: 62660-48600-1)  
Black Nylon

Trim Panel Retaining Clip  
Head Diameter: 16mm  
Stem Diameter: 7mm  
Stem Length: 16mm  
Honda, Mitsubishi & Nissan

UNIT PACKAGE: 25



**14720**  
(HB-121467)  
Black Nylon

Retaining Clip  
Head Diameter: 18mm  
Shank Length: 15mm  
Panel Thickness: 5mm  
Snaps into 8mm Hole

UNIT PACKAGE: 25



**19323**  
(MU481187)  
Black Nylon

Hood Insulation Retainer  
Head Diameter: 26mm  
Stem Diameter: 10mm  
Stem Length: 8mm  
Diamante 1993-On

UNIT PACKAGE: 15



**19385**  
(MB020923)  
Gray Nylon

Hood Insulation Retainer  
Head Diameter: 26mm  
Stem Diameter: 10mm  
Stem Length: 8mm  
Jeep Eagle & Mitsubishi Eclipse 1992 - On

UNIT PACKAGE: 10



**22082**  
(Mitsubishi: MB655630)  
Black Nylon

Hood Insulation Retainer  
Head Diameter: 26mm  
Stem Length: 14mm  
Fits into 9mm Hole  
Mitsubishi Diamante & Montero  
2004 - 1992

UNIT PACKAGE: 15



**21690**  
(Mitsubishi: MR322000)  
White Nylon

Trim Panel Retainer with Sealer  
Top Head Diameter: 12mm  
Bottom Head Diameter: 16mm  
Stem Diameter: 8mm x 8mm  
Stem Length: 14mm  
Diamante, Eclipse, Galant,  
Montero & Outlander 2000 - On

UNIT PACKAGE: 25



**19334**  
(MB566720)  
Natural Nylon

Rear Pillar Trim &  
Air Inlet Grille Retainer  
Top Head Diameter: 12mm  
Bottom Head Diameter: 16mm  
Stem Diameter: 9mm  
Stem Length: 15  
Eclipse 1994-On

UNIT PACKAGE: 15



**19320**  
(MB696120)  
White Nylon

Side Garnish & Moulding Trim Retainer  
Top Head Diameter: 12mm  
Bottom Head Diameter: 16mm  
Stem Diameter: 9mm  
Stem Length: 11mm  
Eclipse 1994-On

UNIT PACKAGE: 15



### 20571

(MR435918)  
White Nylon

Rocker Panel Retainer  
Top Head Diameter: 13mm  
Bottom Head Diameter: 18mm  
Stem Diameter: 9mm  
Stem Length: 9mm  
Montero 2001 - On

UNIT PACKAGE: 15



### 21118

(MB374270, MB374271)  
White Nylon

Trim Panel Retainer  
Top Head Diameter: 13mm  
Middle Head Diameter: 16mm  
Bottom Head Diameter: 18mm  
Stem Diameter: 10mm  
Stem Length: 14mm

Chrysler Laser, Dodge Stealth, Jeep Eagle & Talon and  
Mitsubishi Eclipse & Montero 1989 - On

UNIT PACKAGE: 15



### 19325

(MU481027)  
Brown Nylon

Hood Weatherstrip  
Retainer  
Head Size: 5mm x 13mm  
Stem Diameter: 7mm  
Stem Length: 6mm  
Eclipse & Diamante 1991-On

UNIT PACKAGE: 25



### 21658

(Mitsubishi: MR288150;  
Subaru: 909130013)  
Black Nylon

Push-Type Retainer  
Head Diameter: 15mm  
Stem Length: 11mm  
Fits into 6mm Hole  
Mitsubishi Endeavor, Galant, Lancer, Mirage,  
Montero & Outlander 1997 - On  
Subaru BRZ, Forester, Impreza, Legacy,  
Outback, & XV Crosstrek 2004 - On

UNIT PACKAGE: 10



### 21140

(MB619582)  
Black Nylon

Interior Trim, Bumper & Grille  
Push-Type Retainer  
Head Diameter: 15mm  
Stem Length: 12mm  
Fits into 6.3mm Hole  
Eclipse, Endeavor, Lancer & Outlander 2002 - On

UNIT PACKAGE: 25



### 20580

(MR478262)  
Black Nylon

Bumper Cover & Garnish Moulding  
Push-Type Retainer  
Top Head Diameter: 15mm  
Bottom Head Diameter: 14mm  
Stem Length: 12mm  
Fits into 7mm Hole

#### Use with Auveco 20581

Chrysler Sebring & Stratus  
and Mitsubishi Eclipse 2000 - On

UNIT PACKAGE: 15



### 19239

(Honda: 91512-SX0-003;  
Mitsubishi: MU000319; GM: 11519949)  
Black Nylon

Front Fender & Bumper Support  
Push-Type Retainer  
Head Diameter: 20mm  
Stem Length: 11mm  
Fits into 8mm Hole  
Acura 3.5RL, Honda Accord,  
Prelude & Odyssey 1994-On  
Mitsubishi Lancer 2002-On  
GM 1997 - On

UNIT PACKAGE: 25



### 20247

(MR200300)  
Black Nylon

Fender & Bumper Push-Type Retainer  
Head Diameter: 18mm  
Stem Length: 12mm  
Fits into 9mm Hole  
Honda & Mitsubishi 1998 - On

UNIT PACKAGE: 15



### 17351

(MB-253964)  
Black Nylon

Front & Rear Bumper Push-Type Retainer  
Head Diameter: 17mm  
Stem Length: 10mm  
Fits into 7mm Hole  
Tredia 1988-83

UNIT PACKAGE: 10



### 22077

(Mitsubishi: MB879499)  
Black Nylon

Front Bumper Push-Type Retainer  
Head Diameter: 18mm  
Stem Length: 9mm  
Fits into 9mm Hole  
Mitsubishi Montero 2006 - 01

UNIT PACKAGE: 25

**MITSUBISHI AND NISSAN  
CLIPS & FASTENERS**



**17472**

(Mitsubishi: MB547806;  
Nissan: 63854-01A00)  
Black Nylon

Front Bumper Fascia Push-Type Retainer  
Head Diameter: 20mm  
Stem Length: 20mm  
Fits into 8mm Hole

UNIT PACKAGE: 15



**19140**

(Acura: 90505-SL0-003;  
GM: 94852638;  
Mitsubishi: MB888869;  
Toyota: 90467-08155)  
Black Nylon

Push-Type Retainer  
Head Diameter: 20mm  
Stem Length: 21mm  
Fits into 8mm Hole

Acura, Dodge Avenger, Eagle Talon, Geo Prizm,  
Mitsubishi Eclipse & Galant and Toyota 1993-On

UNIT PACKAGE: 5



**18951**

(MR-138807)  
Black Nylon

Front Bumper & Support  
Push-Type Retainer  
Head Diameter: 20mm  
Stem Length: 26mm  
Fits into 8mm Hole  
Eclipse 1994-On

UNIT PACKAGE: 5



**19328**

(MR201466)  
White Nylon

Trunk Trim Cap  
Eclipse 1994-On

UNIT PACKAGE: 15



**20380**

(Not Supplied by O.E.M.)  
Black Nylon

*Photo not actual size*  
Cable Strap

Width: 5mm (3/16")  
Length: 200mm (8")  
Max. Bundle Diameter: 44mm (1-3/4")  
Fits into 6.3mm (1/4") Hole  
Import Cars

UNIT PACKAGE: 25



**13225**

Plated

U-Type Nut  
Screw Size: 4.2mm (#8)  
Width: 11mm  
Length: 16.5mm  
Panel Range: .5mm-2.5mm  
Center of Hole to Edge: 8mm

UNIT PACKAGE: 50

**NISSAN CLIPS & FASTENERS**



**16860**

(62318-01WOO)  
Dark Gray Nylon

Grille Clip  
Overall Height: 21.5mm (27/32")

UNIT PACKAGE: 25



**21121**

(01553-03831)  
Black Nylon

Grille Clip  
Overall Height: 22mm (7/8")  
Maxima & Stanza 1982 - On

UNIT PACKAGE: 25



**22000**

(Nissan: 01553-05751)  
Gray Nylon

Grille Clip  
Width: 18mm  
Overall Length: 22mm  
Nissan

UNIT PACKAGE: 10

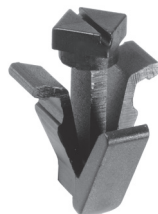

**21619**

(76882-0M060)  
Black Nylon

Grille Clip  
Overall Height: 25mm (1")  
Frontier, Krom & SL 2006 - On

UNIT PACKAGE: 15





## 22301

(Nissan: 01553-05233)  
Black Nylon

Fender Liner Moulding Clip  
Top Width: 31mm  
Bottom Width: 30mm  
Overall Height: 11mm

Infiniti JX35 & QX60 2013 - On  
Nissan Altima, Murano, Pathfinder,  
Rogue & Sentra 2007 - On

UNIT PACKAGE: 25



## 21085

(Not Available from O.E.M.)  
Light Blue Nylon

Rocker Panel Moulding Clip  
Overall Height: 15mm  
Stem Length: 9mm  
Murano 2003 - On

UNIT PACKAGE: 15



## 21291

(76988-4N000)  
White Nylon

Moulding Clip  
Top Head Size: 8mm x 15mm  
Bottom Head Diameter: 15mm  
Stem Diameter: 5.3mm  
Stem Length: 9mm  
Quest & 370Z 2004 - On

UNIT PACKAGE: 25



## 22076

(Nissan: 76882-6P010)  
Natural Nylon

Hood, Front Fender Bracket  
& Exterior Moulding Clip  
Top Head Size: 15mm x 15mm  
Bottom Head Size: 15mm x 15mm  
Stem Length: 15mm  
Overall Length: 22mm  
Infiniti Q45 2001 - 1996  
Nissan Altima & Maxima 2006 - 2002

UNIT PACKAGE: 25



## 21683

(Nissan: 76882-EW00B)  
White Nylon

Rocker Moulding & Exterior Trim  
Moulding Clip with Sealer  
Top Head Size: 6mm x 9mm  
Bottom Head Diameter: 13mm  
Stem Length: 7mm  
Fits into 8mm Hole  
Nissan Altima & Juke 2011 - On

UNIT PACKAGE: 10



## 22061

(Nissan: 76882-JG10A)  
White Nylon

Fender Moulding Clip with Sealer  
Top Head Size: 6mm x 12mm  
Bottom Head Diameter: 16mm  
Stem Length: 10mm  
Infiniti Qx80 2014 - On  
Nissan Juke 2011 - On

UNIT PACKAGE: 25



## 21285

(76882-EG01A)  
Black Nylon

Rocker Panel  
Moulding Clip with Sealer  
Top Head Size: 10mm x 15mm  
Bottom Head Diameter: 18mm  
Stem Length: 12mm  
Fits into 8mm Hole  
Altima and Maxima 2010 - On

UNIT PACKAGE: 15



## 22055

(Nissan: 76847-1JB0A)  
White Nylon

Moulding Clip with Sealer  
Top Head Diameter: 13mm  
Bottom Head Diameter: 13mm  
Stem Length: 11mm  
Fits into 8mm Hole  
Nissan Altima, Quest & Sentra 2011 - On

UNIT PACKAGE: 15



## 21618

(01553-08911)  
White Nylon

Scuff Plate Moulding Clip  
Top Head Size: 12mm x 15mm  
Bottom Head Diameter: 16mm  
Stem Length: 12mm  
Fits into 8.5mm Hole  
Maxima 1999 - On

UNIT PACKAGE: 15



## 20873

(73858-8J000)  
Black Nylon

Drip Rail Moulding Clip  
Width: 13.5mm  
Length: 31mm  
Nissan 2000 - On

UNIT PACKAGE: 10



**20961**

(Not Available from O.E.M.)  
White Nylon

Drip Moulding Clip with Sealer  
Top Width: 25mm  
Overall Height: 16mm  
Fits into 5mm Hole

Infiniti M45, I30 & G35 2005 - On  
Nissan Altima, Maxima & 350Z 2002 - On

UNIT PACKAGE: 15



**20614**

(66820-3S510)  
White Nylon

Cowl Vent Retainer  
Head Size: 10mm x 18mm  
Stem Diameter: 6mm  
Stem Length: 13mm  
Frontier & Xterra 1998 - On

UNIT PACKAGE: 25



**12583**

(76884-90100)  
Nylon

Step Moulding Clip  
Width: 24mm  
Length: 14mm  
Snaps into 8mm Hole

UNIT PACKAGE: 15



**22345**

(Not Available from O.E.M.)  
Black Nylon

Rocker Panel Moulding Clip  
Top Head Size: 14mm x 21.5mm  
Bottom Head Size: 14mm x 21.5mm  
Stem Length: 12mm  
Fits into 9mm Hole  
Nissan Pathfinder

UNIT PACKAGE: 25



**12585**

(255 Y 3616-10)  
Nylon

Side Window Moulding Clip  
Width: 12mm  
Length: 12mm  
Snaps into 5mm Hole

UNIT PACKAGE: 15



**21617**

(76882-0E700)  
White Nylon

Rocker Moulding Clip  
Top Head Size: 14mm x 14mm  
Bottom Head Diameter: 16mm  
Stem Length: 10mm  
Altima 1996 - On

UNIT PACKAGE: 15

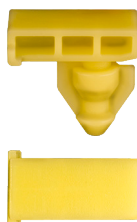

**22281**

(Nissan: 76847-JG00A)  
Yellow Nylon

Wheel Well Opening Moulding Clip  
Head Size: 8mm x 17mm  
Stem Length: 12mm  
Overall Height: 16.5mm  
**Use with Auveco 22257**  
Nissan Juke 2011 - On

UNIT PACKAGE: 25



**22032**

(Nissan: 76988-3DN0A)  
Green Nylon

Windshield Garnish Moulding Clip  
Overall Length: 44mm  
Fits into 7mm x 12mm Hole  
Nissan Altima, Juke  
& Sentra 2011 - On

UNIT PACKAGE: 10



**15468**

(72826-01P00)  
Nylon

Windshield Moulding Clip  
Width: 11mm  
Length: 40mm  
300ZX 1984 - On

UNIT PACKAGE: 15



**17348**

(73856-51E00)  
Nylon

Roof Side Moulding Clip  
Stanza 1990 - On

UNIT PACKAGE: 25



**17349**

(79796-71E00)  
Nylon

Window Reveal Moulding Clip  
Back Glass  
Maxima 1990-On

UNIT PACKAGE: 25



**15470**  
(72727-W1000)  
White Nylon

Windshield Reveal Moulding Clip  
Width: 21mm  
Length: 40mm

UNIT PACKAGE: 15



**21097**  
(Not Available  
from O.E.M.)  
Black Nylon

Windshield Moulding Clip  
Width: 22mm  
Length: 46mm  
Altima 2004 - On

UNIT PACKAGE: 25



**18113**  
(69951-12180)  
Nylon with  
Steel Threaded Insert

Glass Mount  
Thread: M6-1.0  
Nissan, Ford & Imports

UNIT PACKAGE: 5



**13931**  
(26023-H1000)  
White Nylon

Screw Grommet  
For Headlight Adjusting Screws  
Screw Size: 5mm  
Width: 14mm  
Length: 14mm

UNIT PACKAGE: 50



**21930**  
(Renault & Dacia: 77-03-081-160;  
Nissan: 01281-00QAF)  
Natural Nylon

Nylon Nut  
Screw Size: M2.9mm (#4)  
Head Size: 9mm x 9mm  
Stem Length: 7mm  
Renault, Dacia & Nissan

UNIT PACKAGE: 50



**13930**  
(Nissan: 96706-B0700;  
Mazda: 9991-00-412)  
White Nylon

Screw Size: #8  
Width: 9.5mm  
Length: 9.5mm  
Snaps into 7mm x 7mm Hole

UNIT PACKAGE: 50



**14274**  
(Mazda: 9991-00-601;  
Honda: 75521-611-000;  
Nissan: 96706-P0105;  
Toyota: 90189-06010)  
Natural Nylon

Screw Size: #10  
Width: 13mm  
Length: 13mm  
Snaps into 8.5mm x 8.5mm Hole

UNIT PACKAGE: 25



**14334**  
(96706-N8000)  
Natural Nylon

Screw Size: #8  
Width: 12mm  
Length: 15mm  
Fits into 8mm x 12mm Hole

UNIT PACKAGE: 25



**14313**  
(Nissan: 62698-V7000, 68425-H5000;  
Honda: 90662-671-003;  
Mazda: 9991-00-503)  
Natural Nylon

Screw Size: #10  
Width: 17mm  
Length: 17mm  
Snaps into 8mm x 8.5mm Hole

UNIT PACKAGE: 25

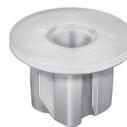

**20764**  
(01281-00831)  
Natural Nylon

Bumper, Fender & Light Screw Grommet  
Screw Size: M4.2 (#8)  
Head Diameter: 16mm  
Stem Length: 10mm  
Fits into 9mm x 9mm Hole  
Nissan 240SX, Altima, Frontier, Maxima, Pathfinder,  
Quest & Xterra and Infiniti 1989 - On

UNIT PACKAGE: 25



**17342**

(01281-00441)  
Black Nylon

Front Bumper Apron  
Nylon Nut  
Screw Size: #10  
Head Diameter: 15mm  
Snaps into 8mm x 8mm Hole  
Stanza 1990-On

UNIT PACKAGE: 25



**21820**

(Not Available from O.E.M.)  
Black Nylon

Nylon Nut  
Screw Size: M5.5 (#12)  
Head Diameter: 15mm  
Stem Length: 8mm  
Fits into 8.5mm x 8.5mm Hole  
Nissan

UNIT PACKAGE: 50



**20266**

(62319-0W000)  
Natural Nylon

Front Bumper Nylon Nut  
Screw Size: M5.5 (#12)  
Head Diameter: 16mm  
Stem Length: 11mm  
Frontier Truck 1997 - On

UNIT PACKAGE: 10



**22274**

(Nissan: 01281-01121)  
White Nylon

Screw Grommet with Sealer  
Screw Size: 2.9mm (#4)  
Head Diameter: 12mm  
Stem Length: 16mm  
Fits into 7mm x 7mm Square Hole  
Infiniti M35h, M45, Q45 & QX50 and  
Nissan Altima, Maxima, Pathfinder, Quest,  
Rogue & Sentra 2012 - 2003

UNIT PACKAGE: 10



**14724**

(96706-H2500)  
Natural Nylon

Screw Grommet  
Screw Size: #6  
Head Diameter: 11.5mm  
Stem Diameter: 9.5mm  
Fits into 7mm x 7mm Hole

UNIT PACKAGE: 25



**14366**

(Nissan: 96706-89901;  
Mazda: 9991-00-402)  
Natural Nylon

Screw Grommet  
Screw Size: #6  
Width: 9.5mm  
Length: 9.5mm  
Stem Length: 16mm  
Fits into 7mm x 7mm Hole

UNIT PACKAGE: 50



**21367**

(01281-00501)  
White Nylon

Body Side Moulding  
Screw Grommet with Sealer  
Screw Size: M3.5 (#6)  
Head Size: 9.5mm x 9.5mm  
Stem Length: 16mm

UNIT PACKAGE: 15



**14335**

(Nissan: 96706-H9400; -K1300, -K1351;  
Mitsubishi: MB-106212)  
Natural Nylon

Screw Grommet  
Screw Size: #4  
Head Diameter: 13.5mm  
Stem Length: 16mm  
Fits into 6mm x 6mm Hole

UNIT PACKAGE: 50



**14695**

(Nissan: 01651-00481 74798-S9000;  
Honda: 90661-SC7-003;  
Mazda: H001-50-841;  
Mitsubishi: MS-480012;  
Toyota: 90189-06042)  
White Nylon

Screw Grommet  
Screw Size: #8  
Head Diameter: 16mm  
Stem Length: 17mm  
Fits into 8mm x 8mm Hole

UNIT PACKAGE: 25



**21324**

(01281-00691)  
Natural Nylon

Screw Grommet with Sealer  
Screw Size: 4.2 (#8)  
Head Diameter: 16mm  
Stem Length: 20mm  
Nissan 240SX, Altima, Frontier, Maxima, Pathfinder &  
Titan and Infiniti I30, I35 & Q45 1989 - On

UNIT PACKAGE: 15





## 22239

(Nissan: 76881-JG00A)  
Black Nylon

Screw Grommet  
Head Diameter: 16mm  
Stem Length: 12mm  
Fits into 8mm x 8mm Hole  
Nissan Murano & Rogue 2014 - On

UNIT PACKAGE: 15



## 20604

(01281-00711)  
Natural Nylon

Rocker Moulding Screw Grommet  
Screw Size: M4.2 (#8) & M4.8 (#10)  
Head Diameter: 20mm  
Stem Length: 15mm  
Nissan & Infiniti 1995 - On

UNIT PACKAGE: 10



## 14275

(Nissan: 01281-00023, 01281-00231;  
Mitsubishi: MB-098145;  
Toyota: 90189-06001)  
White Nylon

Screw Grommet  
Screw Size: #10  
Head Diameter: 18mm  
Stem Length: 17mm  
Fits into 8.5mm x 8.5mm Hole

UNIT PACKAGE: 25



## 21621

(01553-02913)  
White Nylon

Moulding Grommet with Sealer  
Screw Size: M4.2 (#8)  
Head Diameter: 14mm  
Stem Length: 8mm  
Fits into 8mm Hole  
Nissan Frontier, Pathfinder &  
Titan and Infiniti QX4 & QX56 1996 - On

UNIT PACKAGE: 15



## 19293

(01281-00601)  
Natural Nylon

Body Side Moulding  
Floor & Trunk Screw Grommet  
Screw Size: M4.8 (#10)  
Maxima, Sentra, 240SX & 300ZX 1986-On

UNIT PACKAGE: 15



## 22311

(Nissan: 88796-6P000)  
Natural Nylon

Screw Grommet with Sealer  
Screw Size: M4.8 (#10)  
Head Diameter: 16mm  
Stem Length: 15mm  
Nissan Frontier & Rogue 2005 - On

UNIT PACKAGE: 15



## 21768

(Nissan: 63846-5V000)  
White Nylon

Bumper Grommet with Sealer  
Screw Size: M4.8 (#10)  
Head Diameter: 20mm  
Stem Length: 16mm  
Overall Length: 22mm  
Infiniti FX35, FX45, JX35, M35, M36, M37, M56 & QX56  
and Nissan Altima, Juke, Maxima, Murano,  
Quest & Sentra 2003 - On

UNIT PACKAGE: 25



## 22123

(Nissan: 85099-1VA0A)  
White Nylon

Screw Grommet with Sealer  
Screw Size: M5.5 (#12)  
Head Diameter: 19mm  
Stem Length: 16mm  
Overall Length: 20mm  
Nissan LEAF, Pathfinder & Rogue 2011 - On

UNIT PACKAGE: 10



## 21824

(Nissan: 26557-2U001)  
Brown Nylon

Screw Grommet with Sealer  
Screw Size: M6.3-1.81 (#14)  
Head Size: 15mm x 19mm  
Stem Length: 16mm  
Infiniti EX35, G37, JX35, M35, M45, Q50, QX56, QX60  
& QX70 and Nissan 350Z, 370Z, Altima, Armada,  
Cube, Juke, Maxima, Murano, Pathfinder, Quest,  
Rouge, Sentra, Versa & Xterra 2014 - 02

UNIT PACKAGE: 15



## 21111

(01281-00331)  
Natural Nylon

Bumper, Rocker Panel & Light Mounting  
Screw Grommet with Sealer  
Screw Size: M6.3 (#14)  
Head Diameter: 20mm  
Stem Length: 16mm  
Fits into 10mm Square Hole  
Infiniti 1997 - On  
Nissan 1996 - On

UNIT PACKAGE: 25



**22261**

(Nissan: 76848-35F00)  
White Nylon

Moulding Screw Grommet with Sealer  
Head Diameter: 18mm  
Stem Diameter: 8.5mm  
Stem Length: 14mm

Infiniti G35, G37, I30, I35, M35h, Q40, Q50,  
Q70, QX56 & QX80 and Nissan 350Z, Altima,  
Cube, Pathfinder & Sentra 2003 - On

UNIT PACKAGE: 15



**22257**

(Nissan: 76848-JG00A)  
Gray Nylon

Wheel Well Opening &  
Fender Flare Screw Grommet  
Screw Size: M6.3-1.81 (#14)  
Head Size: 12mm x 16mm  
Stem Length: 10mm  
Overall Height: 12mm

**Use with Auveco 22281**  
Nissan Juke & Rogue 2011 - On

UNIT PACKAGE: 15



**20736**

(01281-01081)  
Natural Nylon

Front Bumper Nylon Nut  
Screw Size: M4.8 (#10)  
Flange Diameter: 16mm  
Overall Length: 22mm  
Nissan & Infiniti 1997 - On

UNIT PACKAGE: 15



**22176**

(Nissan: 01281-00431)  
Natural Nylon

Screw Grommet  
Screw Size: M6 (#14)  
Head Size: 14mm x 14mm  
Overall Height: 19mm  
Nissan Murano 2003 - On

UNIT PACKAGE: 25



**14690**

(Nissan: 78856-R4301,  
Honda: 90683-693-000)  
White Nylon

Screw Grommet  
Screw Size: #10  
Width: 12mm  
Length: 19mm  
Stem Length: 17mm  
Fits into 8mm x 15mm Hole

UNIT PACKAGE: 25



**22059**

(Nissan: 76848-54C00)  
Black Nylon

Rear Taillight Assembly & Exterior  
Rocker Moulding Grommet with Sealer  
Head Diameter: 18mm  
Stem Diameter: 8.5mm  
Stem Length: 14mm  
Nissan 2003 - On

UNIT PACKAGE: 25



**21622**

(76848-71S00)  
Yellow Nylon

Pillar Moulding Grommet with Sealer  
Screw Size: M5.5 (#12)  
Head Size: 15.4mm x 19mm  
Stem Length: 15mm  
Nissan 370Z & Quest and  
Infiniti G37 & Q45 2002 - On

UNIT PACKAGE: 15



**20786**

(76848-8J010)  
Black Nylon

Headlight Assembly Grommet  
Head Size: 17mm x 23mm  
Stem Length: 10mm  
Altima 2002 - On

UNIT PACKAGE: 10



**21688**

(Nissan: 01553-02923)  
White Nylon

Moulding Grommet with Sealer  
Head Size: 14mm x 18mm  
Stem Length: 13mm  
Infiniti M45 & Q45 and Nissan Armada,  
Frontier, Pathfinder & Xterra 1996 - On

UNIT PACKAGE: 25



**17196**

(62380-U7400)  
Black Nylon

Grille Grommet  
Width: 22mm  
Length: 26mm  
Nissan 1987 - On

UNIT PACKAGE: 10



### 22287

(Nissan: 62319-AU000)  
Black Nylon

Front Bumper & Grille Screw Grommet  
Head Size: 13.5mm x 23.5mm  
Stem Length: 13mm  
Overall Height: 15mm  
Infiniti G37, M35, M45, QX56 &  
QX80 and Nissan Rogue 2006 - On

UNIT PACKAGE: 15



### 22218

(Nissan: 85284-EG000)  
Yellow Nylon

Rear Bumper Clip  
Width: 20mm  
Length: 32mm  
Overall Height: 25mm  
Nissan GT-R and Infiniti G,  
Q40, FX & QX70 2009 - On

UNIT PACKAGE: 15



### 21318

(01281-0005U)  
Black Nylon

Grille Grommet  
Head Diameter: 20mm  
Stem Length: 13mm  
Fits into 11mm Hole  
Frontier & Titan 2005 - On

UNIT PACKAGE: 25



### 20813

(63846-9E000)  
Natural Nylon

Rear Bumper  
Moulding Grommet with Sealer  
Head Size: 18mm x 18mm  
Stem Length: 15mm  
Altima 2001 - 1998

UNIT PACKAGE: 15



### 22255

(Nissan: 76848-ED000)  
Light Blue Nylon

Rocker & Door Trim Panel Grommet  
Head Diameter: 15mm  
Stem Diameter: 8mm  
Stem Length: 15mm  
Infiniti Q60 Coupe and Nissan 350Z &  
Versa 2014 - 2006

UNIT PACKAGE: 25



### 22128

(Nissan: 66820-9N00A)  
Black Nylon

Cowl & Dash  
Retaining Clip  
Width at Bottom Legs:  
19mm  
Overall Height: 29.5mm  
Nissan 370Z, Leaf &  
Maxima 2009 - On

UNIT PACKAGE: 25

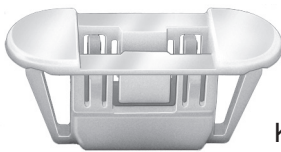

### 19736

(76988-3J000)  
White Nylon

Kick Plate Retainer Grommet  
Head Size: 14mm x 34mm  
Stem Length: 14mm  
Altima 1997-On

UNIT PACKAGE: 15



### 21850

(Nissan: 26398-ED000)  
White Nylon

Tail Light Clip  
Top Head Size: 13mm x 13mm  
Bottom Head Diameter: 19mm  
Stem Length: 10mm  
Infiniti M37, M56 & M Hybrid 2013 - On  
Nissan Armada, Juke, Pathfinder,  
Sentra & Versa 2006 - On

UNIT PACKAGE: 25



### 20790

(85222-0M000)  
Black Nylon

Rear Bumper  
Fascia Clip with Sealer  
Overall Height: 35mm  
Stem Length: 16mm  
Pathfinder 2004 - On

UNIT PACKAGE: 5



### 17633

(66820-88E00)  
Nylon

Cowl Screen Pin Retainer  
Maxima 1990-On

UNIT PACKAGE: 25



**21689**  
 (Nissan: 66820-61U00)  
 Black Nylon

Cowl Grille Retainer  
 Head Diameter: 11mm  
 Stem Diameter: 4.5mm  
 Stem Length: 15mm  
 Infiniti M45 & Q45 and  
 Nissan Sentra 1997 - On

UNIT PACKAGE: 25



**17634**  
 (01553-01781)  
 Black Nylon

Cowl Grille Retainer  
 Head Diameter: 12mm  
 Stem Length: 16mm  
 Stem Diameter: 6mm  
 240SX 1990-On

UNIT PACKAGE: 25



**21588**  
 (80850-CA003)  
 Black Nylon

Weatherstrip Retainer  
 Head Diameter: 8mm  
 Stem Diameter: 5.3mm  
 Stem Length: 7mm  
 Murano & Rouge 2003 - On

UNIT PACKAGE: 25



**14355**  
 (01553-00401)  
 Black Nylon

Retaining Clip  
 Head Diameter: 11mm  
 Stem Length: 13mm  
 Snaps into 5mm Hole  
 Panel Range: 4mm

UNIT PACKAGE: 50



**21295**  
 (01553-08961)  
 Black Nylon

Weatherstrip Retaining Clip  
 Head Diameter: 10mm  
 Stem Diameter: 6mm  
 Stem Length: 8mm  
 Altima 2009 - On

UNIT PACKAGE: 25



**14349**  
 (Mazda: 9926-40-543;  
 Nissan: 01553-00291)  
 Black Nylon

Retaining Clip  
 Head Diameter: 11mm  
 Stem Length: 15mm  
 Panel Thickness: 5mm  
 Fits into 5.5mm Hole

UNIT PACKAGE: 50



**22060**  
 (Nissan: 65810-K2002)  
 Black Nylon

Hood Seal Retaining Clip  
 Head Size: 6.5mm x 16mm  
 Stem Diameter: 3.5mm x 5.5mm  
 Stem Length: 8mm  
 Infiniti 2003 - 1997  
 Nissan 2003 - 1996

UNIT PACKAGE: 25



**14352**  
 (76876-W5000)  
 Black Nylon

Retaining Clip  
 Head Diameter: 13mm  
 Stem Length: 13mm  
 Panel Thickness: 4mm  
 Fits into 5mm Hole

UNIT PACKAGE: 50



**21229**  
 (65810-K2000)  
 Black Nylon

Hood Seal Retaining Clip  
 Head Size: 6.4mm x 16mm  
 Stem Diameter: 3.5mm x 6mm  
 Stem Length: 10mm  
 Nissan Maxima & Pathfinder and  
 Infiniti I30, I35, Q45 & QX4 2004 - 1996

UNIT PACKAGE: 25



**17452**  
 (01553-00545)  
 Black Nylon

Bumper Fascia Retainer  
 Head Diameter: 13mm  
 Stem Length: 15mm  
 Fits into 5mm Hole  
 Sentra 1990-On

UNIT PACKAGE: 25





## 14737

(Nissan: 01553-00172;  
Toyota: 90467-07050)  
Black Nylon

Retaining Clip  
Head Diameter: 13mm  
Stem Length: 15mm  
Panel Thickness: 3mm  
Fits into 5mm Hole

UNIT PACKAGE: 25



## 14723

(62869-N4700)  
Black Nylon

Retaining Clip  
Head Diameter: 14mm  
Stem Length: 11mm  
Panel Thickness: 4mm  
Fits into 6mm Hole

UNIT PACKAGE: 25



## 14353

(76906-T3000)  
Black Nylon

Retaining Clip  
Head Diameter: 14mm  
Stem Length: 16mm  
Panel Thickness: 5mm  
Snaps into 6mm Hole

UNIT PACKAGE: 50



## 14348

(27948-M7002)  
Black Nylon

Retaining Clip  
Head Diameter: 16mm  
Stem Length: 15mm  
Panel Thickness: 4mm  
Snaps into 5mm Hole

UNIT PACKAGE: 25



## 20381

(Honda: 90667-671-013ZA;  
Mitsubishi: MC440901;  
Nissan: 62660-48600-1)  
Black Nylon

Trim Panel Retaining Clip  
Head Diameter: 16mm  
Stem Diameter: 7mm  
Stem Length: 16mm  
Honda, Mitsubishi & Nissan

UNIT PACKAGE: 25



## 14347

(Nissan: 01553-00202;  
Toyota: 90467-10018)  
Black Nylon

Retaining Clip  
Head Diameter: 18mm  
Stem Length: 12mm  
Panel Thickness: 4mm  
Snaps into 7mm Hole  
Nissan & Toyota

UNIT PACKAGE: 50



## 20671

(01553-0052U)  
Black Nylon

Trim Panel Retaining Clip  
Head Diameter: 20mm  
Stem Diameter: 9.5mm  
Stem Length: 15mm  
Frontier Xterra 2000 - On

UNIT PACKAGE: 25

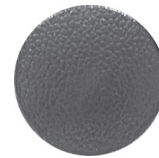

**FasTrack Web is your next step to savings.  
Recover money spent on repair fasteners  
during collision repair jobs.**

**Go to [www.auveco.com](http://www.auveco.com) to learn more about  
Auveco's FasTrack Web  
"Your body shop cost recovery system."**



## 14356

(01553-00051)  
Black Nylon

Retaining Clip  
Head Diameter: 20mm  
Stem Length: 16mm  
Panel Thickness: 7mm  
Snaps into 7mm Hole

UNIT PACKAGE: 50



## 22286

(Nissan: 80287-37F00)  
Natural Nylon

Front Door, Garnish &  
Interior Trim Retaining Clip  
Head Diameter: 14mm  
Stem Length: 10mm  
Overall Height: 11.5mm  
Infiniti FX35, FX45, G35, G37 &  
Q60 and Nissan Murano 2015 - 2003

UNIT PACKAGE: 25



**18948**

(Nissan: 01553-0075U; GM: 1644290)  
Black Nylon

Hood Insulation Retainer  
Head Diameter: 11mm  
Stem Diameter: 5.5mm  
Stem Length: 17.5mm  
Altima & Maxima 2002 - On

UNIT PACKAGE: 25

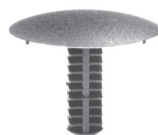

**16775**

(Honda: 90667-SA7-003;  
Nissan: 89427-98070)  
Black Nylon

Trim Panel Retainer  
Head Diameter: 20mm  
Stem Length: 15mm  
Fits into 5mm Hole

UNIT PACKAGE: 25



**21519**

(01553-01A50)  
Black Nylon

Bumper & Trim Retainer  
Head Diameter: 12mm  
Stem Diameter: 6mm  
Stem Length: 15mm  
Infiniti FX35, G35, G37, M35, M45 & Q45  
and Nissan 350Z & 370Z 1997 - On

UNIT PACKAGE: 25



**21288**

(65846-4Z000)  
Black Nylon

Hood Insulation Retainer  
Head Diameter: 28mm  
Stem Diameter: 6mm  
Stem Length: 10mm  
Altima 2010 - On

UNIT PACKAGE: 15



**20256**

(01553-01182)  
Black Nylon

Splash Shield Retainer  
Head Diameter: 15mm  
Stem Diameter: 4.5mm  
Stem Length: 14mm  
Frontier Truck 1997 - On

UNIT PACKAGE: 50



**17237**

(65832-F5000, 65846-30F00)  
Black Nylon

Hood Insulation Retainer  
Outer Diameter: 29.5mm  
Stem Diameter: 7mm  
Stem Length: 9mm  
Nissan 1981-On

UNIT PACKAGE: 15



**16776**

(Honda: 90667-SA0-003;  
Nissan: 76996-01P02)  
Black Nylon

Trim Panel Retainer  
Head Diameter: 18mm  
Stem Length: 20mm  
Fits into 6mm Hole

UNIT PACKAGE: 25



**20672**

(66820-3S500-C1)  
White Nylon

Cowl Vent Retainer  
Top Head Diameter: 13mm  
Bottom Head Diameter: 16mm  
Stem Diameter: 4mm  
Stem Length: 13mm  
Frontier & Xterra 1998 - On

UNIT PACKAGE: 25



**22075**

(Nissan: 01553-06451)  
Black Nylon

Upper Quarter Trim &  
Rear Trunk Seal Retainer  
Head Diameter: 20mm  
Stem Diameter: 8.7mm  
Stem Length: 16mm

Infiniti G35, J30, JX60, M35, M37, M56, Q45, Q50 &  
QX60 and Nissan Altima, Pathfinder & Quest 1996 - On

UNIT PACKAGE: 25



**22063**

(Nissan: 01553-02903)  
White Nylon

Front Side Lower Fender  
Panel Bracket Retainer  
Top Head Diameter: 13mm  
Bottom Head Diameter: 12mm  
Stem Length: 14mm  
Overall Length: 21mm  
Infiniti Qx4 & Qx56 and Nissan Pathfinder,  
Frontier & Xterra 2010 - 1997

UNIT PACKAGE: 25



**21289**  
(84953-JA00A)  
Yellow Nylon

Trim Panel Retainer  
Top Head Diameter: 12.5mm  
Middle Head Diameter: 16mm  
Bottom Head Diameter: 18mm  
Stem Diameter: 9.5mm  
Stem Length: 14mm  
Altima 2010 - On

UNIT PACKAGE: 25



**19731**  
(84915-0W000)  
White Nylon

Trim Panel Retainer  
Top Head Diameter: 13mm  
Middle Head Diameter: 16mm  
Bottom Head Diameter: 17mm  
Stem Diameter: 9.5mm  
Stem Length: 13mm  
Pathfinder 1995 - On

UNIT PACKAGE: 15



**20669**  
(01553-07111)  
Black Nylon

Trim Panel Retainer  
Top Head Diameter: 13mm  
Middle Head Diameter: 15mm  
Bottom Head Diameter: 18mm  
Stem Diameter: 9mm  
Stem Length: 15mm  
Nissan Altima and  
Infiniti G35 & Q45 1997 - On

UNIT PACKAGE: 25



**21998**  
(Nissan: 01553-08101)  
Yellow & White Nylon

Trim Panel Retainer  
Top Head Diameter: 13mm  
Middle Head Diameter: 16mm  
Bottom Head Diameter: 17mm  
Stem Length: 9mm  
Overall Length: 18.5mm  
Fits into 8mm Hole  
Nissan

UNIT PACKAGE: 10



**21414**  
(80999-VE000)  
White Nylon

Trim Panel Retainer with Sealer  
Top Head Diameter: 13mm  
Middle Head Diameter: 16mm  
Bottom Head Diameter: 18mm  
Stem Diameter: 9mm  
Stem Length: 13mm  
Infiniti & Nissan 1993 - On

UNIT PACKAGE: 25



**22237**  
(Nissan: 01553-30001)  
White Nylon

Trim Panel Retainer  
Top Head Diameter: 13mm  
Middle Head Diameter: 16.5mm  
Bottom Head Diameter: 18mm  
Stem Diameter: 9mm  
Stem Length: 13mm  
Nissan Altima, Cube, GT-R, Murano,  
Pathfinder, Quest, Rogue, Sentra,  
Versa & Versa Note 2007 - On

UNIT PACKAGE: 25



**21701**  
(Nissan: 85284-4J500)  
Black Nylon

Retainer with Sealer  
Top Head Diameter: 13mm  
Middle Head Diameter: 16mm  
Bottom Head Diameter: 18mm  
Stem Diameter: 10mm  
Stem Length: 11mm  
Overall Length: 17mm  
Infiniti I35 and Nissan Altima,  
Cube & Maxima 2011 - 02

UNIT PACKAGE: 10



**20668**  
(01553-09791)  
White Nylon

Trim Panel Retainer  
Top Head Diameter: 13mm  
Middle Head Diameter: 16mm  
Bottom Head Diameter: 18mm  
Stem Diameter: 9mm  
Stem Length: 14mm  
Nissan & Infiniti 1999 - On

UNIT PACKAGE: 15



**20670**  
(01553-02821)  
Gray Nylon

Trim Panel Retainer  
Top Head Diameter: 13mm  
Middle Head Diameter: 16mm  
Bottom Head Diameter: 18mm  
Stem Diameter: 8.5mm  
Stem Length: 12mm  
Maxima 1988 - On

UNIT PACKAGE: 15



**13945**  
(01553-S3500)  
White Nylon

Door Trim Panel Retainer  
Trucks

UNIT PACKAGE: 50



**18166**  
(80875-85E00)  
Black Nylon

Trim Panel Retainer  
Head Diameter: 10mm  
Stem Length: 10mm  
Stem Diameter: 4mm  
Maxima 1989-On

UNIT PACKAGE: 25



**21633**  
(80850-89900)  
White Nylon

Weatherstrip Retainer  
Head Size: 6mm x 16mm  
Stem Diameter: 6.5mm  
Stem Length: 12mm  
Nissan Maxima and  
Infiniti I30, I35 & M45 2004 - 2000

UNIT PACKAGE: 25



**19724**  
(65810-K2009)  
White Nylon

Hood to Cowl  
Seal Retainer  
Head Size: 6mm x 16mm  
Stem Length: 15mm  
Fits into 5mm Hole  
Infiniti & Pathfinder 1992 - On

UNIT PACKAGE: 25



**19684**  
(01553-09311)  
Blue Nylon

Weatherstrip Retainer  
Head Size: 7mm x 16mm  
Stem Length: 12mm  
Fits into 6mm Hole  
Altima & Sentra 1994-On

UNIT PACKAGE: 25



**22107**  
(Nissan: 80850-JM01A)  
Black Nylon

Weatherstrip Retainer  
Head Size: 6mm x 15mm  
Stem Size: 5.6mm x 7mm  
Stem Length: 12mm  
Overall Length: 16mm  
Nissan Rogue 2008 - On

UNIT PACKAGE: 25



**16783**  
(66824-01G00)  
Black Nylon

Push-Type Retainer  
Head Diameter: 12mm  
Stem Length: 8mm (Excluding the Pin)  
Fits into 6mm Hole

UNIT PACKAGE: 25



**21159**  
(66820-AX020)  
Black Nylon

Cowl Vent & Outside Mirror  
Push-Type Retainer  
Head Diameter: 14mm  
Stem Length: 10mm  
Fits into 6mm Hole  
Pathfinder & Versa 2005 - On

UNIT PACKAGE: 15



**16859**  
(Nissan: 66860-01W01;  
GM: 94051993)  
Black Nylon

Cowl Panel to Reinforcement Plate &  
Engine Splash Shield Retainer  
Head Diameter: 14mm (9/16")  
Stem Length: 16mm (5/8")  
Fits into 6mm (1/4") Hole  
Nissan 1980-On  
Geo Storm 1990-On

UNIT PACKAGE: 25





## 14696

(Nissan: 10998-30880;  
Honda: 90684-SA5-003;  
Isuzu: 8942981190)  
Black Nylon



Push-Type Retainer  
Head Diameter: 15mm  
Stem Length: 11mm  
Fits into 6mm Hole

UNIT PACKAGE: 25



## 21620

(01553-06071)  
Black Nylon

Rear Duct Finishing Panel  
Push-Type Retainer  
Head Diameter: 15mm  
Stem Length: 14mm  
Fits into 5mm Hole  
Cube S, SL, Krom & Leaf 2012 - On

UNIT PACKAGE: 15



## 18265

(76882-57A00)  
Black Nylon

Body Side Moulding  
Push-Type Retainer  
Head Diameter: 16mm  
Stem Length: 20mm  
Fits into 8mm Hole  
Sentra 1986-On

UNIT PACKAGE: 25



## 14726

(63844-01A99)  
Black Nylon

Push-Type Retainer  
Head Diameter: 17mm  
Stem Length: 18mm  
Fits into 8mm Hole

UNIT PACKAGE: 25



## 16784

(Nissan: 80999-05N07;  
Toyota: 90467-07043)  
Black Nylon

Push-Type Retainer  
Head Diameter: 18mm  
Stem Length: 11mm (Excluding the Pin)  
Fits into 7mm Hole

UNIT PACKAGE: 25



## 22039

(Nissan: 01553-2DR9A)  
Black Nylon

Push-Type Retainer  
Top Head Diameter: 16mm x 19mm  
Bottom Head Diameter: 20mm  
Stem Length: 12mm  
Fits into 8mm Hole  
Infiniti G20, JX35, Q45 & QX60 and Nissan Frontier,  
Maxima, NV, Pathfinder, Sentra,  
Versa & Xterra 2002 - On

UNIT PACKAGE: 15



## 20349

(Nissan: 01553-09611;  
Toyota: 90467-08185)  
Black Nylon

Bumper Clip  
Push-Type Retainer  
Head Diameter: 18mm  
Stem Length: 10mm (Excluding the Pin)  
Fits into 8mm Hole  
Maxima 1994 - On  
Toyota & Lexus 2002 - On

UNIT PACKAGE: 15



## 21311

(01553-0038U)  
Gray Nylon

Bumper Push-Type Retainer  
Head Diameter: 18mm  
Stem Length: 12mm  
Fits into 8mm Hole  
Frontier, Pathfinder & Xterra 2005 - On

UNIT PACKAGE: 10



## 19246

(01553-09241)  
Black Nylon

Bumper Push-Type Retainer  
Head Diameter: 18mm  
Stem Length: 15mm  
Fits into 10mm Hole  
240SX & Maxima 1994-On

UNIT PACKAGE: 15



## 21876

(Renault & Dacia: 05-40-000-1R;  
Nissan: 01515-00Q0C)  
Black Nylon

Bumper Push-Type Retainer  
Head Diameter: 18mm  
Stem Length: 18mm  
Fits into 9mm Hole  
Renault, Dacia & Nissan

UNIT PACKAGE: 15



**20613**  
(63848-40Y00)  
Black Nylon

Front Bumper Push-Type Retainer  
Head Diameter: 18mm  
Stem Length: 20mm  
Fits into 9mm Hole  
Frontier & Xterra 1998 - On

UNIT PACKAGE: 15



**20327**  
(63848-9E001)  
Black Nylon

Bumper Fascia  
Push-Type Retainer  
Head Diameter: 18mm  
Stem Length: 19mm (Excluding the Pin)  
Fits into 9mm Hole  
Altima 1997 - On

UNIT PACKAGE: 10



**16782**  
(Honda: 91545-SE0-003-W;  
Nissan: 63848-01G00)  
Black Nylon

Push-Type Retainer  
Head Diameter: 20mm  
Stem Length: 8mm (Excluding the Pin)  
Fits into 8mm Hole

UNIT PACKAGE: 25



**21631**  
(84995-3J101)  
Black Nylon

Push-Type Retainer  
Head Diameter: 20mm  
Stem Length: 8mm (Excluding the Pin)  
Fits into 8mm Hole  
Sentra 2007 - On

UNIT PACKAGE: 15



**21134**  
(01553-09431)  
Black Nylon

Front Bumper Push-Type Retainer  
Head Diameter: 20mm  
Stem Length: 11mm (Excluding the Pin)  
Fits into 8mm Hole  
Maxima 2004 - On

UNIT PACKAGE: 15



**21545**  
(01553-08231)  
Black Nylon

Front & Rear Bumper  
and Grille Push-Type Retainer  
Head Diameter: 20mm  
Stem Length: 15mm  
Fits into 8mm Hole  
Nissan Murano, 240 SX & 350Z  
and Infiniti FX35, FX45 & Q45 1995 - On

UNIT PACKAGE: 25



**16858**  
(Nissan: 63844-01A00;  
Kia: MNA01-56-145;  
Mazda: NA01-56-145;  
Ford: MNA01-56145, NA01-56145)  
Black Nylon

Inner Fender Push-Type Retainer  
Head Diameter: 20mm (25/32")  
Stem Length: 18mm (23/32")  
Fits into 8mm (5/16") Hole  
Nissan 1980-On  
Mazda, Kia & Ford

UNIT PACKAGE: 25



**16000**  
(Honda: 90675-SB3-003;  
Mazda: FB01-56-964;  
Nissan: 63876-95596)  
Black Nylon

Push-Type Retainer  
Head Diameter: 20mm  
Stem Length: 9mm  
Fits into 8mm Hole

UNIT PACKAGE: 25



**20348**  
(63878-01E10)  
Black Nylon

Push-Type Retainer  
Head Diameter: 20mm  
Stem Length: 22mm  
Fits into 8mm Hole  
Maxima 1994 - On

UNIT PACKAGE: 15



**19905**  
(01553-10051)  
Black Nylon

Push-Type Retainer  
Head Diameter: 20mm  
Stem Length: 8mm (Excluding the Pin)  
Fits into 8mm Hole  
Maxima 1999 - On

UNIT PACKAGE: 15



**19274**  
(01553-09321)  
Black Nylon

Push-Type Retainer  
Head Diameter: 20mm  
Stem Length: 9mm (Excluding the Pin)  
Fits into 8mm Hole  
Maxima & 300ZX 1994-On

UNIT PACKAGE: 15



**17472**  
(Mitsubishi: MB547806;  
Nissan: 63854-01A00)  
Black Nylon

Front Bumper Fascia  
Push-Type Retainer  
Head Diameter: 20mm  
Stem Length: 20mm  
Fits into 8mm Hole  
300ZX 1990-On

UNIT PACKAGE: 15



**21192**  
(Nissan: 01553-05323)  
(Mazda: L33X13209)  
Black Nylon

Cowl, Bumper & Fender Liner  
Push-Type Retainer  
Head Diameter: 20mm  
Stem Length: 12mm  
Fits into 8mm Hole  
Infiniti FX35, FX45, G35  
and Nissan 2003 - On  
Mazda 2, 3, 5, 6, CX-5, CX-7  
& CX-9 2007 - On

UNIT PACKAGE: 10



**17378**  
(01553-03101)  
Black Nylon

Bumper & Fascia  
Push-Type Retainer  
Head Diameter: 22mm  
Stem Length: 14mm  
Fits into 11mm Hole  
Nissan 1986 - On

UNIT PACKAGE: 15



**20953**  
(11296-AG000)  
Black Nylon

Front Bumper and Radiator Support  
Push-Type Retainer  
Head Diameter: 20mm  
Stem Length: 13mm (Excluding the Pin)  
Fits into 8mm Hole  
Infiniti FX 35/45 and Nissan Altima,  
Maxima & Quest 2002 - On

UNIT PACKAGE: 25



**20753**  
(01553-03201)  
Black Nylon

Front & Rear Bumper  
Push-Type Retainer  
Head Diameter: 22mm  
Stem Length: 21mm  
Fits into 8mm Hole  
Nissan 1982 - On

UNIT PACKAGE: 10



**17347**  
(01553-06721)  
Black Nylon

Front & Rear Bumper Cover  
Push-Type Retainer  
Head Diameter: 20mm  
Stem Length: 11mm (Excluding the Pin)  
Fits into 8mm Hole  
Maxima & Infiniti 1990 - On

UNIT PACKAGE: 15



**17350**  
(Honda 91516-SK7-013;  
Nissan 01553-00344)  
Black Nylon

Splash Shield Push-Type Retainer  
Phillips Drive  
Hex: 10mm  
Head Diameter: 20mm  
Stem Length: 15mm  
Fits into 8mm Hole  
Civic 1992 - On  
Nissan XTerra, Frontier, &  
Quest 1999 - On

UNIT PACKAGE: 10



**21361**  
(GM: 11561874;  
Nissan: 622A2-9E000A)  
Black Nylon

Bumper Cover Push-Type Retainer  
Head Diameter: 25mm  
Stem Length: 29mm  
Fits into 7mm Hole  
Chevrolet Malibu 2008 - On  
Saturn Aura 2007 - On  
Pontiac G6 2010 - On  
Nissan Altima 1997 - On

UNIT PACKAGE: 15



**16725**  
(66814-01G00)  
Black Nylon

Cowl Grille Retainer  
Head Size: 8mm x 12mm  
Stem Length: 8mm  
Fits into 6mm Square Hole  
Nissan Pick-Up 1986 - On

UNIT PACKAGE: 25



**14725**  
(66824-W1000)  
Black Nylon

Push-Type Retainer  
Head Width: 12mm  
Head Length: 18mm  
Stem Length: 10mm  
Fits into 6mm Hole

UNIT PACKAGE: 15



**14727**  
(Nissan: 63844-D0100;  
GM: 94221150; Isuzu: 8942211500)  
Black Nylon

Push-Type Retainer  
Screw: 5mm x 14mm  
Head Size: 14mm x 22mm  
Stem Length: 9mm  
Fits into 7mm Hole

UNIT PACKAGE: 25



**16843**  
(Mazda: BF82-50-233;  
Nissan: 01553-01393)  
Black Nylon

Bumper Cover Retainer  
Head Size: 20mm x 30mm  
Stem Length: 18mm  
Fits into 10mm Hole

UNIT PACKAGE: 10



**22275**  
(Nissan: 28945-CA000)  
Black Nylon

Tube/Cable Routing Clip  
Holds 7mm Diameter Tube/Cable  
Overall Height: 21.5mm  
Nissan Murano & Rogue 2012 - On

UNIT PACKAGE: 25



**21999**  
(Nissan: 01552-00661)  
Natural Nylon

Tube/Cable Routing Clip  
Tube/Cable Diameter: 5mm  
Snaps into 6mm Hole  
Nissan

UNIT PACKAGE: 15



**16780**  
(Nissan: 99604-H1400;  
Toyota: 58788-13010)  
Natural Nylon

Hood Prop Rod Clip  
Holds 11mm Diameter Rod  
Fits into 10mm x 12mm Hole

UNIT PACKAGE: 10

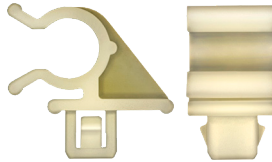

**22362**  
(Nissan: 65722-50A00)  
Natural Nylon

Hood Prop Rod Clip  
Holds 8mm Diameter Rod  
Overall Height: 20.5mm  
Fits into 8mm Square Hole  
Nissan Juke 2013 - 2011

UNIT PACKAGE: 15



**14337**  
(84653-N7400)  
Black Nylon

Tube/Cable Routing Clip  
Holds 5mm Tube or Cable  
Snaps into 5mm Hole

UNIT PACKAGE: 25



**14345**  
(24220-89986)  
White Nylon

Hood Prop Rod Clip  
Holds 10mm Rod  
Snaps into 8mm Hole

UNIT PACKAGE: 10



**21309**  
(65722-EA000)  
Black Nylon

Hood Prop Rod Clip  
Rod Size: 8mm  
Overall Length: 33mm  
Frontier, Pathfinder & Xterra 2005 - On

UNIT PACKAGE: 10



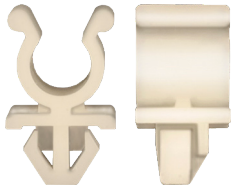

## 22358

(Nissan: 65722-01E00)  
White Nylon

Hood Prop Rod Clip  
Holds 8mm Diameter Rod  
Overall Height: 23mm  
Fits into 9mm Hole

Infiniti G20 & QX4 2003 - 1991

Nissan 200SX, 240SX, 300ZX, 370Z, Altima, Frontier,  
Pathfinder, Sentra, Stanza & Xterra 1986 - On

UNIT PACKAGE: 15



## 21646

(80874-AX000)  
Black Nylon

Hole Plug  
Head Diameter: 25mm  
Fits into 18mm Hole

Nissan Juke & Murano and Infiniti EX35 2003 - On

UNIT PACKAGE: 25



## 21637

(01553-05131)  
Black Nylon

Wheel Liner, Cowl Insulator  
& Trim Flange Clip  
Flange Diameter: 25mm  
Hex: 10.5mm

Overall Height: 12.5mm

Nissan 370Z, Altima, Cube, Frontier, GT-R, Juke, Leaf,  
Maxima, Murano, NV, Pathfinder, Quest, Rouge, Versa  
& Xterra and Infiniti EX35, FX35, FX50, G25, G35,  
G37, J30, M35, M45 & Q45 1993 - On

UNIT PACKAGE: 15

## 20380

(Not Supplied by O.E.M.)  
Black Nylon



*Photo not actual size*  
Cable Strap

Width: 5mm (3/16")

Length: 200mm (8")

Max. Bundle Diameter: 44mm (1-3/4")

Fits into 6.3mm (1/4") Hole

Import Cars

UNIT PACKAGE: 25

## 21259

(24225-89960)  
Black Nylon



*Photo not actual size*  
Cable Strap

Overall Length: 200mm (8")

Width: 8mm (5/16")

Maximum Bundle Diameter: 55mm (2-3/16")

Snaps into 8mm (5/16") Hole

Nissan 2005 - On

UNIT PACKAGE: 25



## 16340

(54229-0201P)  
Zinc

Window Crank Handle  
Retaining Clip

UNIT PACKAGE: 100



## 19147

(62228-51S00)

Front Bumper Retainer  
300ZX 1992 - On

UNIT PACKAGE: 10



## 22198

(Nissan: 11296-3TA0A)  
Zinc Organic

Trim Retaining Clip  
Overall Height: 18.5mm  
Width from Ear to Ear: 11mm  
Nissan Altima 2013 - On

UNIT PACKAGE: 50



## 21664

(63848-9Y000)  
Black Nylon

Fender Apron Clip  
Width: 20mm  
Width at Wings: 30mm  
Overall Length: 30mm

Nissan Altima, Maxima, Murano, Pathfinder, Quest &  
370Z and Infiniti EX35, FX35, FX50, G35,  
G37, M35, M37, M45 & M56 2005 - On

UNIT PACKAGE: 10



## 21017

(76882-0M000)  
White Nylon

Nylon U-Nut  
Screw Size: M4.8 (#10)  
Panel Range: Up to 1.5mm  
Center of Hole to Edge: 8mm  
Nissan & Infiniti 1995 - On

UNIT PACKAGE: 15



## 17193

(63848-D0100)  
Black Nylon

Nylon U-Nut  
Fender/Wheel Housing  
Screw Size: M5.5 (#12)  
Width: 20mm  
Length: 20mm  
Panel Range: Up to 1mm  
Center of Hole to Edge: 9mm

UNIT PACKAGE: 15



**19735**

(63848-35F00)  
Black Nylon

Fender Clip U-Nut  
Screw Size: M4.8 (#10)  
Width: 20mm  
Length: 32mm  
Panel Range: Up to 2mm  
Center of Hole to Edge: 8mm  
Maxima & 240SX 1994 - On

UNIT PACKAGE: 15

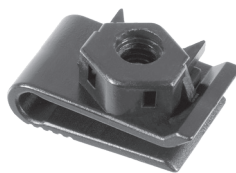

**21459**

(01241-00881)  
Black Nylon

Nylon U-Nut  
with Captive Metal Hex Nut  
Thread: M6 - 1.0  
Center of Hole to Edge: 14mm  
Panel Range: Up to 4mm  
Nissan Altima, Maxima &  
240SX and Infiniti I30 2001 - 1993

UNIT PACKAGE: 10

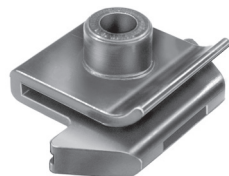

**17385**

(63848-D4000)  
Black Nylon

Nylon U-Nut  
Fender/Wheel Housing  
Screw Size: M5.5 (#12)  
Width: 31mm  
Length: 22mm  
Panel Range: Up to 2mm  
Center of Hole to Edge: 9mm  
Sentra

UNIT PACKAGE: 10



**13225**

Plated

U-Type Nut  
Screw Size: 4.2mm (#8)  
Width: 11mm  
Length: 16.5mm  
Panel Range: .5mm-2.5mm  
Center of Hole to Edge: 8mm

UNIT PACKAGE: 50

**OPEL CLIPS & FASTENERS**

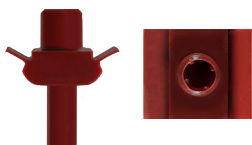

**12642**

(1-74-713)  
Nylon

Moulding Clip

UNIT PACKAGE: 10

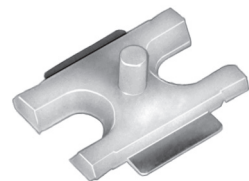

**19153**

(1-74-820, 03467-531)  
Nylon

Moulding Clip

UNIT PACKAGE: 25



**21859**

(Mercedes-Benz: 000-990-29-92,  
000-990-60-92; 001-990-16-92, 114-990-01-92;  
Opel: 1104882, 1719245;  
Volvo: 9133417, 1268642)  
Black Nylon

Push-Type Retainer  
Head Diameter: 16mm  
Stem Length: 11mm  
Fits into 8mm Hole  
Mercedes-Benz, Opel & Volvo 1985 - On

UNIT PACKAGE: 15



**13216**

Zinc

U-Type Nut  
Screw Size: 4.8mm  
Panel Range: .9mm-2.0mm  
Center of Hole to Edge: 8mm

UNIT PACKAGE: 25



**13220**

(Mercedes: 000-994-09-45;  
Volvo: 946-418; Opel: 20-72-175)  
Plated

U-Type Nut  
Screw Size: 6.3mm  
Panel Range: .7mm-1.5mm  
Center of Hole to Edge: 13mm

UNIT PACKAGE: 50

# PEUGEOT AND CITROEN CLIPS & FASTENERS

Sec. 22



## 21929

(Peugeot & Citroen: 6987.A1)  
Black Nylon

Nylon Nut  
Screw Size: M2.9 (#4)  
Head Size: 9.5mm x 9.5mm  
Stem Length: 7mm  
Peugeot, Citroen, Renault & Dacia

UNIT PACKAGE: 50



## 21874

(Peugeot & Citroen: 7427.46;  
Renault & Dacia: 77-03-081-184)  
White Nylon

Screw Grommet  
Screw Size: M4.2 (#8)  
Head Diameter: 15mm  
Stem Length: 15mm  
Peugeot, Citroen, Renault & Dacia

UNIT PACKAGE: 25



## 21962

(Peugeot & Citroen: 7136.A5)  
White Nylon

Nylon Nut  
Screw Size: M4.2 (#8)  
Head Size: 12mm x 12mm  
Stem Length: 11mm  
Peugeot & Citroen

UNIT PACKAGE: 15



## 21958

(Renault & Dacia: 77-03-081-233)  
White Nylon

Screw Grommet  
Screw Size: M2.9 (#4)  
Head Size: 9.5mm x 15mm  
Stem Length: 9mm  
Peugeot, Citroen, Renault & Dacia

UNIT PACKAGE: 25



## 21931

(Peugeot & Citroen: 7136.J7;  
Renault & Dacia: 77-03-081-163)  
Natural Nylon

Nylon Nut  
Screw Size: M2.9 (#4)  
Head Size: 13mm x 13mm  
Stem Length: 10mm  
Peugeot, Citroen, Renault & Dacia

UNIT PACKAGE: 25



## 21960

(Peugeot & Citroen: 6997.96;  
Renault & Dacia: 77-03-081-185)  
Natural Nylon

Screw Grommet  
Screw Size: M2.9 (#4)  
Head Size: 13mm x 20mm  
Stem Length: 15mm  
Peugeot, Citroen, Renault & Dacia

UNIT PACKAGE: 15



## 21965

(Peugeot & Citroen: 6991.39)  
Natural Nylon

Nylon Nut  
Screw Size: M6 (#14)  
Head Size: 16mm x 16mm  
Stem Length: 10mm  
Peugeot & Citroen

UNIT PACKAGE: 25



## 21964

(Peugeot & Citroen: 7410.E2)  
Natural Nylon

Screw Grommet  
Screw Size: M2.9 (#4)  
Top Head Size: 11mm x 18mm  
Bottom Head Size: 14mm x 21mm  
Overall Length: 17mm  
Peugeot & Citroen

UNIT PACKAGE: 10



## 21963

Light Gray Nylon

Screw Grommet  
Screw Size: M2.9 (#4)  
Head Diameter: 16mm  
Stem Length: 15mm  
Peugeot & Citroen

UNIT PACKAGE: 10



## 21959

(Peugeot & Citroen: 6990.62;  
Renault & Dacia: 77-03-081-134)  
Black Nylon

Screw Grommet  
Screw Size: M3.5 (#6)  
Head Size: 13.5mm x 20mm  
Stem Length: 15mm  
Peugeot, Citroen, Renault & Dacia

UNIT PACKAGE: 10

**PEUGEOT AND CITROEN  
CLIPS & FASTENERS**



**21961**

(Peugeot & Citroen: 8749.ZA;  
Renault & Dacia: 77-03-081-232)  
Natural Nylon

Screw Grommet with Black Rubber Sealer  
Screw Size: M4.2 (#8)  
Head Size: 10.5mm x 17.5mm  
Stem Length: 15mm  
Peugeot, Citroen, Renault & Dacia

UNIT PACKAGE: 10



**21979**

(Peugeot & Citroen: 6992.S2)  
Natural Nylon

Tubular Nut  
Inside Diameter: 6mm  
Head Diameter: 12mm  
Stem Length: 25mm  
Peugeot & Citroen

UNIT PACKAGE: 15



**21942**

(Peugeot & Citroen: 6983.24)  
Black Nylon

Trim Retaining Clip  
Head Diameter: 9.3mm  
Stem Diameter: 6.5mm  
Stem Length: 13mm  
Peugeot & Citroen

UNIT PACKAGE: 25



**21943**

(Peugeot & Citroen: 8749.Q5)  
Gray Nylon

Trim Retaining Clip  
Head Diameter: 12mm  
Stem Diameter: 7.5mm  
Stem Length: 13mm  
Peugeot & Citroen

UNIT PACKAGE: 25



**21880**

(Peugeot & Citroen: 6999.T4)  
Black Nylon

Weatherstrip Retaining Clip  
Head Diameter: 12mm  
Stem Diameter: 7mm  
Stem Length: 10mm  
Peugeot & Citroen

UNIT PACKAGE: 50



**21919**

Black Nylon

Weatherstrip Retaining Clip  
Head Size: 7mm x 12mm  
Stem Diameter: 7mm  
Stem Length: 9mm  
Peugeot, Citroen, Renault & Dacia

UNIT PACKAGE: 25



**21918**

(Peugeot & Citroen: 9025.J8)  
Black Nylon

Weatherstrip Retaining Clip  
Head Size: 7mm x 12mm  
Stem Diameter: 8mm  
Stem Length: 9mm  
Peugeot, Citroen, Renault & Dacia

UNIT PACKAGE: 25



**21920**

Black Nylon

Weatherstrip Retaining Clip  
Head Size: 9mm x 18mm  
Stem Diameter: 8.5mm  
Stem Length: 10mm  
Peugeot, Citroen, Renault & Dacia

UNIT PACKAGE: 25



**21949**

Black Nylon

Weatherstrip Retainer  
Head Size: 5mm x 12mm  
Stem Diameter: 7mm  
Stem Length: 10mm  
Peugeot & Citroen

UNIT PACKAGE: 25



**21879**

(Peugeot & Citroen: 6995.V6)  
Black Nylon

Hood Insulation Retainer  
Head Diameter: 20mm  
Stem Diameter: 8mm  
Stem Length: 10mm  
Peugeot & Citroen

UNIT PACKAGE: 25



**21808**

(Peugeot & Citroen: 6992.31)  
White Nylon

Interior Trim Retainer  
Head Diameter: 10mm  
Stem Diameter: 8mm  
Stem Length: 15mm  
Peugeot & Citroen

UNIT PACKAGE: 25

# PEUGEOT AND CITROEN CLIPS & FASTENERS

Sec. 22



## 21936

(Peugeot & Citroen: 6992.07)  
Black Nylon

Trim Panel Retainer  
Head Diameter: 11.5mm  
Stem Diameter: 5.5mm  
Stem Length: 12mm  
Peugeot & Citroen

UNIT PACKAGE: 25



## 21868

(Peugeot & Citroen: 6999.R1;  
Renault & Dacia: 77-03-077-174)  
Black Nylon

Trim Panel Retainer  
Head Diameter: 20mm  
Stem Diameter: 8mm  
Stem Length: 17mm  
Peugeot, Citroen, Renault & Dacia

UNIT PACKAGE: 25



## 21878

(Peugeot & Citroen: 8964.57)  
Black Nylon

Trunk Lining Retainer  
Head Diameter: 14mm  
Stem Diameter: 7.5mm x 8mm  
Stem Length: 16mm  
Peugeot & Citroen

UNIT PACKAGE: 25



## 21947

(Peugeot & Citroen: 7437.10)  
Black Nylon

Trim Panel Retainer  
Head Diameter: 16mm  
T30 Torx® Drive  
Stem Diameter: 5.5mm  
Stem Length: 26mm  
Peugeot & Citroen

UNIT PACKAGE: 10



## 21938

(Peugeot & Citroen: 7588.VX)  
Black Nylon

Trim Panel Retainer  
Head Diameter: 18mm  
Stem Diameter: 7mm  
Stem Length: 17mm  
Peugeot & Citroen

UNIT PACKAGE: 25



## 21809

(Peugeot & Citroen: 6983.17)  
Black Nylon

Retainer  
Head Diameter: 21mm  
Stem Diameter: 7.5mm  
Stem Length: 23mm  
Peugeot & Citroen

UNIT PACKAGE: 25



## 21940

(Peugeot & Citroen: 6992.95)  
Black Nylon

Trim Panel Retainer  
Head Diameter: 18mm  
Stem Diameter: 7.3mm  
Stem Length: 16mm  
Peugeot & Citroen

UNIT PACKAGE: 25



## 21937

(Peugeot & Citroen: 6992.W9)  
Black Nylon

Trim Panel Retainer  
Head Diameter: 21mm  
Stem Diameter: 7.7mm  
Stem Length: 16mm  
Peugeot & Citroen

UNIT PACKAGE: 25



## 21877

(Peugeot & Citroen: 6992.C6)  
Black Nylon

Radiator Panel Retainer  
Head Diameter: 19.5mm  
Stem Diameter: 7mm  
Stem Length: 13mm  
Peugeot & Citroen

UNIT PACKAGE: 25



## 21939

(Peugeot & Citroen: 7589.V4)  
Tan Nylon

Trim Panel Retainer  
Head Diameter: 21mm  
Stem Diameter: 7.7mm  
Stem Length: 16mm  
Peugeot & Citroen

UNIT PACKAGE: 15



**PEUGEOT AND CITROEN  
CLIPS & FASTENERS**



**21941**  
(Peugeot & Citroen: 9128.S1)  
Light Gray Nylon

Trim Panel Retainer  
Head Diameter: 21mm  
Stem Diameter: 7.7mm  
Stem Length: 16mm  
Peugeot & Citroen

UNIT PACKAGE: 10



**21977**  
(Renault & Dacia: 77-01-049-008)  
White Nylon

Trim Panel Retainer  
Top Head Diameter: 13mm  
Bottom Head Diameter: 18mm  
Stem Diameter: 11.5mm  
Stem Length: 12mm  
Peugeot, Citroen, Renault & Dacia

UNIT PACKAGE: 25



**21975**  
(Peugeot & Citroen: 6991.43;  
Renault & Dacia: 77-03-077-059)  
White Nylon

Trim Panel Retainer  
Top Head Diameter: 14mm  
Bottom Head Diameter: 17mm  
Stem Diameter: 9mm  
Stem Length: 10mm  
Peugeot, Citroen, Renault & Dacia

UNIT PACKAGE: 25



**21871**  
(Peugeot & Citroen: 6995.A3;  
Renault & Dacia: 77-03-077-111)  
White Nylon

Trim Panel Retainer with Sealer  
Top Head Diameter: 13mm  
Bottom Head Diameter: 16.5mm  
Stem Diameter: 8.7mm  
Stem Length: 11mm  
Peugeot, Citroen, Renault & Dacia

UNIT PACKAGE: 25



**21814**  
(Peugeot: 6991.S6;  
Renault: 77-03-077-468)  
White Nylon

Door Panel Retainer  
Top Head Diameter: 13mm  
Middle Head Diameter: 16mm  
Bottom Head Diameter: 18mm  
Stem Diameter: 12mm  
Stem Length: 11mm  
Overall Length: 18.5mm  
Renault, Dacia, Peugeot and Citroen

UNIT PACKAGE: 25



**21974**  
(Peugeot & Citroen: 6992.82)  
White Nylon

Trim Panel Retainer with Sealer  
Top Head Diameter: 14mm  
Middle Head Diameter: 17mm  
Bottom Head Diameter: 17mm  
Stem Diameter: 8.5mm  
Stem Length: 11mm  
Peugeot & Citroen

UNIT PACKAGE: 25



**21916**  
(Peugeot & Citroen: 8335.TE;  
Renault & Dacia: 82-00-700-969)  
Yellow Nylon

Trim Panel Retainer  
Top Head Diameter: 12.3mm  
Middle Head Diameter: 15mm  
Bottom Head Diameter: 18mm  
Stem Diameter: 12mm  
Stem Length: 13mm  
Peugeot, Citroen, Renault & Dacia

UNIT PACKAGE: 25



**21895**  
(Peugeot & Citroen: 6991.Z1;  
Renault & Dacia: 82-00-909-084)  
Blue Nylon

Trim Panel Retainer  
Top Head Diameter: 13mm  
Middle Head Diameter: 16mm  
Bottom Head Diameter: 18mm  
Stem Diameter: 12mm  
Stem Length: 12mm  
Peugeot, Citroen, Renault & Dacia

UNIT PACKAGE: 25

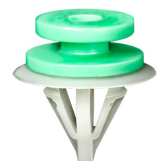

**21944**  
(Peugeot & Citroen: 8742.G2)  
Green & White Nylon

Trim Panel Retainer  
Top Head Diameter: 12.5mm  
Middle Head Diameter: 14mm  
Bottom Head Diameter: 18mm  
Stem Diameter: 10.5mm  
Stem Length: 12mm  
Peugeot, Citroen, Renault & Dacia

UNIT PACKAGE: 10



**21978**  
(Peugeot & Citroen: 6992.J4)  
White Nylon

Trim Panel Retainer  
Top Head Diameter: 14mm  
Middle Head Diameter: 16.5mm  
Bottom Head Diameter: 17mm  
Stem Diameter: 9mm  
Stem Length: 10mm  
Peugeot & Citroen

UNIT PACKAGE: 25

# PEUGEOT AND CITROEN CLIPS & FASTENERS

Sec. 22



## 21822

(Peugeot & Citroen: 6822.LL)  
White Nylon

Door Panel Retainer  
Top Head Diameter: 13mm  
Middle Head Diameter: 16mm  
Bottom Head Diameter: 18mm  
Stem Diameter: 8.5mm x 9mm  
Stem Length: 14mm  
Overall Length: 20mm  
Peugeot, Citroen & Toyota

UNIT PACKAGE: 25



## 21976

(Peugeot & Citroen: 6966.39)  
White Nylon

Trim Panel Retainer  
Top Head Diameter: 16mm  
Middle Head Diameter: 16mm  
Bottom Head Diameter: 16.5mm  
Stem Diameter: 8.7mm  
Stem Length: 13mm  
Overall Length: 20mm  
Peugeot & Citroen

UNIT PACKAGE: 15



## 21884

(Peugeot & Citroen: 6990.50)  
White Nylon

Trim Panel Retainer  
Top Head Diameter: 11mm  
Middle Head Diameter: 16mm  
Bottom Head Diameter: 18mm  
Stem Diameter: 8mm  
Stem Length: 13mm  
Overall Length: 21.3mm  
Peugeot & Citroen

UNIT PACKAGE: 25



## 21967

(Peugeot & Citroen: 6902.07)  
Black Nylon

Push-Type Retainer  
Head Diameter: 8mm  
Stem Length: 7mm  
Fits into 3.5mm Hole  
Peugeot & Citroen

UNIT PACKAGE: 100



## 21968

(Peugeot & Citroen: 6972.24;  
Renault & Dacia: 77-03-072-224)  
Black Nylon

Push-Type Retainer  
Head Diameter: 8mm  
Stem Length: 8mm  
Fits into 4mm Hole  
Peugeot, Citroen, Renault & Dacia

UNIT PACKAGE: 25



## 21881

(Peugeot & Citroen: 6972.11)  
Black Nylon

Mud Flap Push-Type Retainer  
Head Diameter: 10mm  
Stem Length: 12mm  
Fits into 6.3mm Hole  
Peugeot & Citroen

UNIT PACKAGE: 25



## 21972

(Peugeot & Citroen: 6992.18)  
Black Nylon

Push-Type Retainer  
Top Head Diameter: 10.5mm  
Bottom Head Diameter: 11mm  
Stem Length: 6mm  
Fits into 6mm Hole  
Overall Length: 24.5mm  
Peugeot & Citroen

UNIT PACKAGE: 15



## 21882

(Peugeot & Citroen: 6991.F0;  
Renault & Dacia: 77-03-072-261)  
Black Nylon

Push-Type Retainer  
Torx® Drive (T27)  
Head Diameter: 12mm  
Stem Length: 14mm  
Fits into 6mm Hole  
Peugeot, Citroen, Renault & Dacia

UNIT PACKAGE: 25



## 21875

(Peugeot & Citroen: 6555.LE;  
Renault & Dacia: 77-03-072-236)  
Black Nylon

Push-Type Retainer  
Torx® Drive (T27)  
Head Diameter: 12.5mm  
Stem Length: 9mm  
Fits into 6mm Hole  
Peugeot, Citroen, Renault & Dacia

UNIT PACKAGE: 25



## 21970

(Peugeot & Citroen: 6990.C4)  
Black Nylon

Push-Type Retainer  
Head Diameter: 13mm  
Stem Length: 10mm  
Fits into 6mm Hole  
Peugeot & Citroen

UNIT PACKAGE: 25

**PEUGEOT AND CITROEN  
CLIPS & FASTENERS**



**21969**  
(Peugeot & Citroen: 8748.C2)  
Charcoal Gray Nylon

Push-Type Retainer  
Head Diameter: 16mm  
Stem Length: 10mm  
Fits into 6mm Hole  
Peugeot & Citroen

UNIT PACKAGE: 25



**21883**  
(Peugeot & Citroen: 6991.X7)  
Black Nylon

Bumper Push-Type Retainer  
Head Diameter: 20mm  
Stem Length: 14mm  
Fits into 8mm Hole  
Peugeot & Citroen

UNIT PACKAGE: 25



**21971**  
(Peugeot & Citroen: 6973.34)  
Black Nylon

Push-Type Retainer  
Head Diameter: 16mm  
Stem Length: 14mm  
Fits into 9mm Hole  
Peugeot & Citroen

UNIT PACKAGE: 25



**21810**  
(Peugeot & Citroen: 6997.T2)  
Black Nylon

Push-Type Retainer  
Head Diameter: 22mm  
Stem Length: 14mm  
Fits into 6.3mm Hole  
Peugeot & Citroen

UNIT PACKAGE: 25



**21973**  
(Peugeot & Citroen: 1539.16)  
Tan Nylon

Push-Type Retainer  
Head Diameter: 20mm  
Stem Length: 10mm  
Fits into 6mm Hole  
Peugeot & Citroen

UNIT PACKAGE: 10



**21813**  
(Peugeot & Citroen: 6973.A9)  
Black Nylon

Nylon Rivet  
Diameter: 4mm  
Grip: 1.2mm - 6.5mm  
Flange Diameter: 9mm  
Peugeot & Citroen

UNIT PACKAGE: 25



**21811**  
(Peugeot & Citroen: 8211.WV)  
Black Nylon

Push-Type Retainer  
Head Diameter: 20mm  
Stem Length: 10mm  
Fits into 8mm Hole  
Peugeot & Citroen

UNIT PACKAGE: 25



**21966**  
Yellow Nylon

Nylon U-Nut  
Screw Size: M4.2 (#8)  
Panel Range: Up to 2.5mm  
Center of Hole to Edge: 7mm  
Overall Height: 12.5mm  
Peugeot & Citroen

UNIT PACKAGE: 10



**21812**  
(Peugeot & Citroen: 16-092-672-80;  
Renault: 77-03-072-416)  
Black Nylon

Push-Type Retainer  
Rectangular Head Size: 9mm x 20mm  
Head Diameter: 20mm  
Stem Length: 13mm  
Fits into 8mm Hole  
Renault, Dacia, Peugeot and Citroen

UNIT PACKAGE: 25



**21934**  
White Nylon

Heat Shield Nylon U-Nut  
Screw Size: M4.8 (#10)  
Panel Range: Up to 3mm  
Hole Center to Edge: 8mm  
Overall Height: 16mm  
Peugeot, Citroen, Renault & Dacia

UNIT PACKAGE: 10

# RENAULT AND DACIA CLIPS & FASTENERS

Sec. 22



**21929**  
(Peugeot & Citroen: 6987.A1)  
Black Nylon  
Nylon Nut  
Screw Size: M2.9 (#4)  
Head Size: 9.5mm x 9.5mm  
Stem Length: 7mm  
Peugeot, Citroen, Renault & Dacia  
UNIT PACKAGE: 50



**21930**  
(Renault & Dacia: 77-03-081-160;  
Nissan: 01281-00QAF)  
Natural Nylon  
Nylon Nut  
Screw Size: M2.9mm (#4)  
Head Size: 9mm x 9mm  
Stem Length: 7mm  
Renault, Dacia & Nissan  
UNIT PACKAGE: 50



**21931**  
(Peugeot & Citroen: 7136.J7;  
Renault & Dacia: 77-03-081-163)  
Natural Nylon  
Nylon Nut  
Screw Size: M2.9 (#4)  
Head Size: 13mm x 13mm  
Stem Length: 10mm  
Peugeot, Citroen, Renault & Dacia  
UNIT PACKAGE: 25



**9377**  
(Renault: 8934-201-263; Chrysler: 6000943)  
White Nylon  
Radiator Grille Nut  
Screw Size: #8  
UNIT PACKAGE: 100



**11855**  
(Renault: 8934-201-262; GM: 9669486)  
Natural Nylon  
Screw Size: #8  
Rear License Plate Bracket Nut  
AMC-Renault  
Side Marker Nut  
GM 1980-On  
UNIT PACKAGE: 25



**21874**  
(Peugeot & Citroen: 7427.46;  
Renault & Dacia: 77-03-081-184)  
White Nylon  
Screw Grommet  
Screw Size: M4.2 (#8)  
Head Diameter: 15mm  
Stem Length: 15mm  
Peugeot, Citroen, Renault & Dacia  
UNIT PACKAGE: 25



**21958**  
(Renault & Dacia: 77-03-081-233)  
White Nylon  
Screw Grommet  
Screw Size: M2.9 (#4)  
Head Size: 9.5mm x 15mm  
Stem Length: 9mm  
Peugeot, Citroen, Renault & Dacia  
UNIT PACKAGE: 25



**21959**  
(Peugeot & Citroen: 6990.62;  
Renault & Dacia: 77-03-081-134)  
Black Nylon  
Screw Grommet  
Screw Size: M3.5 (#6)  
Head Size: 13.5mm x 20mm  
Stem Length: 15mm  
Peugeot, Citroen, Renault & Dacia  
UNIT PACKAGE: 10



**21960**  
(Peugeot & Citroen: 6997.96;  
Renault & Dacia: 77-03-081-185)  
Natural Nylon  
Screw Grommet  
Screw Size: M2.9 (#4)  
Head Size: 13mm x 20mm  
Stem Length: 15mm  
Peugeot, Citroen, Renault & Dacia  
UNIT PACKAGE: 15



**21961**  
(Peugeot & Citroen: 8749.ZA;  
Renault & Dacia: 77-03-081-232)  
Natural Nylon  
Screw Grommet with  
Black Rubber Sealer  
Screw Size: M4.2 (#8)  
Head Size: 10.5mm x 17.5mm  
Stem Length: 15mm  
Peugeot, Citroen, Renault & Dacia  
UNIT PACKAGE: 10



**21932**  
(Renault & Dacia: 77-03-081-225)  
Natural Nylon  
Screw Grommet with  
Black Rubber Sealer  
Screw Size: M2.9 (#4)  
Head Diameter: 11mm  
Stem Length: 16mm  
Renault & Dacia  
UNIT PACKAGE: 10



**RENAULT AND DACIA  
CLIPS & FASTENERS**



**12713**  
(GM: 10032838; 1264963;  
Chrysler: 6031869;  
Renault: 8934-201-602)  
Natural Nylon

High Torque  
Screw Grommet

UNIT PACKAGE: 25



**13464**  
(8934-201-235)  
Natural Nylon  
Grille Retainer Screw Grommet  
Screw Size: 4.2mm (#8)

UNIT PACKAGE: 25



**13966**  
(8934-201-767)  
Black Nylon  
Tubular Barrel Nut  
For 3/16" Stud  
Barrel Length 17/64"  
Head Diameter: 5/16"  
Head Thick 1/32"  
For Hole Diameter 17/64"

UNIT PACKAGE: 100

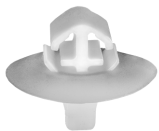

**21897**  
(Renault & Dacia: 77-03-077-420)  
White Nylon

Moulding Clip  
Head Diameter: 20mm  
Stem Length: 9mm  
Overall Length: 16.5mm  
Renault & Dacia

UNIT PACKAGE: 15



**21915**  
(Renault & Dacia: 77-03-081-056)  
Black Nylon

Retainer  
Flange Diameter: 30mm  
Fits on 6mm Stud  
Overall Height: 14mm  
Renault & Dacia

UNIT PACKAGE: 25



**21919**  
Black Nylon  
Weatherstrip Retaining Clip  
Head Size: 7mm x 12mm  
Stem Diameter: 7mm  
Stem Length: 9mm  
Peugeot, Citroen, Renault & Dacia

UNIT PACKAGE: 25



**21918**  
(Peugeot & Citroen: 9025.J8)  
Black Nylon

Weatherstrip Retaining Clip  
Head Size: 7mm x 12mm  
Stem Diameter: 8mm  
Stem Length: 9mm  
Peugeot, Citroen, Renault & Dacia

UNIT PACKAGE: 25



**21920**  
Black Nylon  
Weatherstrip Retaining Clip  
Head Size: 9mm x 18mm  
Stem Diameter: 8.5mm  
Stem Length: 10mm  
Peugeot, Citroen, Renault & Dacia

UNIT PACKAGE: 25



**21908**  
(Renault & Dacia: 77-03-077-449)  
Black Nylon

Trim Panel Retaining Clip  
Head Diameter: 18mm  
Stem Diameter: 11mm  
Stem Length: 12mm  
Renault & Dacia

UNIT PACKAGE: 25



**21909**  
(Renault & Dacia: 82-00-110-307)  
Gray Nylon

Trim Panel Retaining Clip  
Head Diameter: 18mm  
Stem Diameter: 11.3mm  
Stem Length: 12mm  
Renault & Dacia

UNIT PACKAGE: 25



**21870**  
(Renault & Dacia: 77-03-077-457)  
Light Gray Nylon

Trim Retaining Clip  
Head Diameter: 18mm  
Stem Diameter: 11.5mm  
Stem Length: 13mm  
Renault & Dacia

UNIT PACKAGE: 25



**21800**  
(Renault: 77-03-077-080)  
Black Nylon

Retainer  
Head Diameter: 13mm  
Stem Diameter: 7mm  
Stem Length: 15mm  
Renault and Dacia

UNIT PACKAGE: 25



# RENAULT AND DACIA CLIPS & FASTENERS

Sec. 22



**21801**  
(Not Available from O.E.M.)  
White Nylon

Retainer  
Head Diameter: 13mm  
Stem Diameter: 7mm  
Stem Length: 17mm  
Renault and Dacia

UNIT PACKAGE: 25



**12993**  
(7703-077-066)  
Black Nylon

Rear Window Moulding Retainer  
Alliance 1983-On

UNIT PACKAGE: 25



**21910**  
(Renault & Dacia: 77-03-077-487)  
Black Nylon

Trim Panel Retainer  
Head Diameter: 16mm  
Stem Diameter: 9mm  
Stem Length: 20mm  
Renault & Dacia

UNIT PACKAGE: 25



**21911**  
(Renault & Dacia: 77-03-077-464)  
Gray Nylon

Trim Panel Retainer  
Head Diameter: 16mm  
Stem Diameter: 9mm  
Stem Length: 20mm  
Renault & Dacia

UNIT PACKAGE: 15



**21912**  
(Renault & Dacia: 77-03-077-153)  
Black Nylon

Trim Panel Retainer  
Head Diameter: 16mm  
Stem Diameter: 9mm  
Stem Length: 20mm  
Renault & Dacia

UNIT PACKAGE: 15



**21913**  
(Renault & Dacia: 77-03-077-107)  
Dark Gray Nylon

Trim Panel Retainer  
Head Diameter: 16mm  
Stem Diameter: 12mm  
Stem Length: 19mm  
Renault & Dacia

UNIT PACKAGE: 25



**21802**  
(Renault: 77-03-077-231;  
Fiat: 14591787)  
Black Nylon

Retainer  
Head Diameter: 15mm  
Stem Diameter: 8mm  
Stem Length: 17mm  
Renault, Dacia and Fiat

UNIT PACKAGE: 25



**21803**  
(Fiat: 14592087)  
Black Nylon

Retainer  
Head Diameter: 20mm  
Stem Diameter: 8mm  
Stem Length: 23mm  
Renault, Dacia and Fiat

UNIT PACKAGE: 25



**21804**  
(Fiat: 14592086)  
Gray Nylon

Retainer  
Head Diameter: 20mm  
Stem Diameter: 8mm  
Stem Length: 23mm  
Renault, Dacia and Fiat

UNIT PACKAGE: 25



**21868**  
(Peugeot & Citroen: 6999.R1;  
Renault & Dacia: 77-03-077-174)  
Black Nylon

Trim Panel Retainer  
Head Diameter: 20mm  
Stem Diameter: 8mm  
Stem Length: 17mm  
Peugeot, Citroen, Renault & Dacia

UNIT PACKAGE: 25



**21905**  
(Renault & Dacia: 82-00-721-200)  
Gray Nylon

Trim Panel Retainer  
Head Diameter: 21mm  
Stem Diameter: 7.5mm  
Stem Length: 19mm  
Renault & Dacia

UNIT PACKAGE: 25

**RENAULT AND DACIA  
CLIPS & FASTENERS**



**21900**  
(Renault & Dacia: 77-03-077-453)  
Black Nylon

Trim Panel Retainer  
Head Diameter: 24mm  
Stem Diameter: 7mm  
Stem Length: 10mm  
Renault & Dacia

UNIT PACKAGE: 15



**21914**  
(Renault & Dacia: 77-03-074-315)  
Black Nylon

Trim Panel Retainer  
Head Diameter: 40mm  
Stem Diameter: 10.5mm  
Stem Length: 26mm  
Renault & Dacia

UNIT PACKAGE: 10



**21906**  
(Renault & Dacia: 77-03-077-090)  
Black Nylon

Trim Panel Retainer  
Head Diameter: 30mm  
Stem Diameter: 8mm  
Stem Length: 18mm  
Renault & Dacia

UNIT PACKAGE: 10



**21495**  
(VW: 7L5-853-994)  
Blue Nylon

Trim Panel Retainer  
Top Head Diameter: 13mm  
Bottom Head Diameter: 18mm  
Stem Diameter: 9mm  
Stem Length: 14mm  
Renault, VW & Audi

UNIT PACKAGE: 25



**21907**  
(Renault & Dacia: 82-00-321-368)  
Gray Nylon

Trim Panel Retainer  
Head Diameter: 30mm  
Stem Diameter: 8mm  
Stem Length: 18mm  
Renault & Dacia

UNIT PACKAGE: 10



**21977**  
(Renault & Dacia: 77-01-049-008)  
White Nylon

Trim Panel Retainer  
Top Head Diameter: 13mm  
Bottom Head Diameter: 18mm  
Stem Diameter: 11.5mm  
Stem Length: 12mm  
Peugeot, Citroen, Renault & Dacia

UNIT PACKAGE: 25

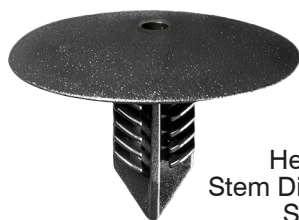

**21805**  
(Renault: 77-03-077-435)  
Black Nylon

Retainer  
Head Diameter: 35mm  
Stem Diameter: 10mm x 10.5mm  
Stem Length: 22mm  
Renault and Dacia

UNIT PACKAGE: 25



**21871**  
(Peugeot & Citroen: 6995.A3;  
Renault & Dacia: 77-03-077-111)  
White Nylon

Trim Panel Retainer with Sealer  
Top Head Diameter: 13mm  
Bottom Head Diameter: 16.5mm  
Stem Diameter: 8.7mm  
Stem Length: 11mm  
Peugeot, Citroen, Renault & Dacia

UNIT PACKAGE: 25



**21806**  
(Renault: 77-03-077-225)  
Black Nylon

Retainer  
Head Diameter: 35mm  
Stem Diameter: 10.5mm  
Stem Length: 22mm  
Renault and Dacia

UNIT PACKAGE: 25



**21896**  
Gray Nylon

Trim Panel Retainer  
Top Head Diameter: 13.3mm  
Bottom Head Diameter: 18mm  
Stem Diameter: 9.3mm  
Stem Length: 13mm  
Renault & Dacia

UNIT PACKAGE: 25

# RENAULT AND DACIA CLIPS & FASTENERS

Sec. 22



**21975**  
(Peugeot & Citroen: 6991.43;  
Renault & Dacia: 77-03-077-059)  
White Nylon

Trim Panel Retainer  
Top Head Diameter: 14mm  
Bottom Head Diameter: 17mm  
Stem Diameter: 9mm  
Stem Length: 10mm  
Peugeot, Citroen, Renault & Dacia  
UNIT PACKAGE: 25



**21895**  
(Peugeot & Citroen: 6991.Z1;  
Renault & Dacia: 82-00-909-084)  
Blue Nylon

Trim Panel Retainer  
Top Head Diameter: 13mm  
Middle Head Diameter: 16mm  
Bottom Head Diameter: 18mm  
Stem Diameter: 12mm  
Stem Length: 12mm  
Peugeot, Citroen, Renault & Dacia  
UNIT PACKAGE: 25



**21917**  
Yellow Nylon

Trim Panel Retainer with Sealer  
Top Head Diameter: 12.3mm  
Middle Head Diameter: 15mm  
Bottom Head Diameter: 18mm  
Stem Diameter: 12mm  
Stem Length: 13mm  
Overall Length: 19mm  
Renault & Dacia  
UNIT PACKAGE: 15



**21944**  
(Peugeot & Citroen: 8742.G2)  
Green & White Nylon

Trim Panel Retainer  
Top Head Diameter: 12.5mm  
Middle Head Diameter: 14mm  
Bottom Head Diameter: 18mm  
Stem Diameter: 10.5mm  
Stem Length: 12mm  
Peugeot, Citroen, Renault & Dacia  
UNIT PACKAGE: 10



**21814**  
(Peugeot: 6991.S6;  
Renault: 77-03-077-468)  
White Nylon

Door Panel Retainer  
Top Head Diameter: 13mm  
Middle Head Diameter: 16mm  
Bottom Head Diameter: 18mm  
Stem Diameter: 12mm  
Stem Length: 11mm  
Overall Length: 18.5mm  
Renault, Dacia, Peugeot and Citroen  
UNIT PACKAGE: 25



**21873**  
(BMW: 51-43-7-001-491)  
White Nylon

Trim Panel Retainer  
Top Head Diameter: 14mm  
Middle Head Diameter: 15mm  
Bottom Head Diameter: 18mm  
Stem Diameter: 9.5mm  
Stem Length: 14mm  
Renault, Dacia & BMW  
UNIT PACKAGE: 25



**21916**  
(Peugeot & Citroen: 8335.TE;  
Renault & Dacia: 82-00-700-969)  
Yellow Nylon

Trim Panel Retainer  
Top Head Diameter: 12.3mm  
Middle Head Diameter: 15mm  
Bottom Head Diameter: 18mm  
Stem Diameter: 12mm  
Stem Length: 13mm  
Overall Length: 19mm  
Peugeot, Citroen, Renault & Dacia  
UNIT PACKAGE: 25



**13475**  
(VW: 175-867-299;  
Renault: 8934-201-681)  
White Nylon

Trim Panel Retainer  
Head Diameter: 19mm  
Stem Length: 18mm  
Stem Diameter: 9mm  
AMC Renault 1984-On  
VW 1982-On  
UNIT PACKAGE: 50



**21968**  
(Peugeot & Citroen: 6972.24;  
Renault & Dacia: 77-03-072-224)  
Black Nylon

Push-Type Retainer  
Head Diameter: 8mm  
Stem Length: 8mm  
Fits into 4mm Hole  
Peugeot, Citroen, Renault & Dacia  
UNIT PACKAGE: 25

**RENAULT AND DACIA  
CLIPS & FASTENERS**



**21882**

(Peugeot & Citroen: 6991.F0;  
Renault & Dacia: 77-03-072-261)  
Black Nylon

Push-Type Retainer  
Torx® Drive (T27)  
Head Diameter: 12mm  
Stem Length: 14mm  
Fits into 6mm Hole  
Peugeot, Citroen, Renault & Dacia

UNIT PACKAGE: 25



**21876**

(Renault & Dacia: 05-40-000-1R;  
Nissan: 01515-00Q0C)  
Black Nylon

Bumper Push-Type Retainer  
Head Diameter: 18mm  
Stem Length: 18mm  
Fits into 9mm Hole  
Renault, Dacia & Nissan

UNIT PACKAGE: 15



**21875**

(Peugeot & Citroen: 6555.LE;  
Renault & Dacia: 77-03-072-236)  
Black Nylon

Push-Type Retainer  
Torx® Drive (T27)  
Head Diameter: 12.5mm  
Stem Length: 9mm  
Fits into 6mm Hole  
Peugeot, Citroen, Renault & Dacia

UNIT PACKAGE: 25



**21812**

(Peugeot & Citroen: 16-092-672-80;  
Renault: 77-03-072-416)  
Black Nylon

Push-Type Retainer  
Rectangular Head Size: 9mm x 20mm  
Head Diameter: 20mm  
Stem Length: 13mm  
Fits into 8mm Hole  
Renault, Dacia, Peugeot and Citroen

UNIT PACKAGE: 25



**21935**

(Renault & Dacia: 77-03-072-361)  
Black Nylon

Push-Type Retainer  
Head Diameter: 12mm  
Stem Length: 10mm  
Fits into 6mm Hole  
Renault & Dacia

UNIT PACKAGE: 15



**21921**

(Renault & Dacia: 77-01-030-059)  
Pink Nylon

Door Lock Rod Clip  
Use on Left-Hand Side  
Rod Size: 2.5mm  
Renault & Dacia

UNIT PACKAGE: 15



**21898**

(Renault & Dacia: 77-03-072-352)  
Black Nylon

Push-Type Retainer  
Head Diameter: 17.5mm  
Stem Length: 9mm  
Fits into 6mm Hole  
Renault & Dacia

UNIT PACKAGE: 10



**21922**

(Renault & Dacia: 77-01-030-059)  
White Nylon

Door Lock Rod Clip  
Use on Right-Hand Side  
Rod Size: 2.5mm  
Renault & Dacia

UNIT PACKAGE: 15



**21807**

(Renault: 77-03-072-360)  
Black Nylon

Push-Type Retainer  
Head Diameter: 18mm  
Stem Length: 14mm  
Fits into 8mm Hole  
Renault and Dacia

UNIT PACKAGE: 25



**21923**

(Renault & Dacia: 77-01-030-058)  
Green Nylon

Door Lock Rod Clip  
Use on Left-Hand Side  
Rod Size: 3mm  
Renault & Dacia

UNIT PACKAGE: 10

# RENAULT, DACIA, SAAB AND SUBARU CLIPS & FASTENERS

Sec. 22



**21927**  
(Renault & Dacia: 77-01-030-060)  
White Nylon

Door Lock Rod Clip  
Use on Right-Hand Side  
Rod Size: 4mm  
Renault & Dacia

UNIT PACKAGE: 15



**21926**  
(Renault & Dacia: 77-01-030-060)  
Yellow Nylon

Door Lock Rod Clip  
Use on Left-Hand Side  
Rod Size: 4mm  
Renault & Dacia

UNIT PACKAGE: 15



**13216**  
Zinc

U-Type Nut  
Screw Size: 4.8mm  
Panel Range: .9mm-2mm  
Center of Hole to Edge: 8mm

UNIT PACKAGE: 25



**21934**  
White Nylon

Heat Shield Nylon U-Nut  
Screw Size: M4.8 (#10)  
Panel Range: Up to 3mm  
Center of Hole to Edge: 8mm  
Overall Height: 16mm  
Peugeot, Citroen, Renault & Dacia

UNIT PACKAGE: 10

## SAAB



**21540**  
(GM: 24449408)  
Orange Nylon

Bumper, Grille, Wheel Apron & Lights  
Nylon Extruded U-Nut  
Screw Size: M5.5 (#12)  
Panel Range: Up to 2mm  
Center of Hole to Edge: 12mm  
**Use with Auveco 21541**  
Buick Lacrosse & Regal 2011 - On  
Saab 9-3 & 9-5 2003 - On  
Saturn Astra 2009 - 08

UNIT PACKAGE: 25

# SUBARU CLIPS & FASTENERS



**22042**  
(Subaru: 57160FC010)  
White Nylon

Upper Front Bumper  
Extension Moulding Clip  
Top Head Size: 9mm x 11mm  
Bottom Head Size: 14mm x 17mm  
Stem Length: 11mm  
Forester 2005 - 1998

UNIT PACKAGE: 25



**21771**  
Subaru: 909130008)  
Pink Nylon

Moulding Clip with Sealer  
Top Head Size: 11mm x 14mm  
Bottom Head Diameter: 17mm  
Stem Diameter: 10mm  
Stem Length: 11mm  
Baja, Forester, Impreza, Legacy,  
Outback & Tribeca 2000 - On

UNIT PACKAGE: 25



**21581**  
(91059FC030)  
White Nylon

Front & Rear Door Fender,  
Quarter Panel and Lift Gate  
Moulding Clip with Sealer  
Top Head Size: 11mm x 14mm  
Bottom Head Diameter: 17mm  
Stem Length: 12mm  
Fits into 9mm Hole  
B9 Tribeca, Forester, Impreza  
& Outback 1998 - On

UNIT PACKAGE: 25



**21564**  
(91059FC110)  
White Nylon

Moulding Clip with Sealer  
Head Size: 21.5mm x 24mm  
Stem Diameter: 14.5mm  
Stem Length: 17mm  
Forester 2002 - 01

UNIT PACKAGE: 25





**21572**  
(91059FC090)  
Black Nylon

Grille Clip  
Top Head Size: 15.5mm x 11mm  
Bottom Head Size: 19.5mm x 14mm  
Stem Length: 11mm  
Forester & Legacy 2008 - 1991

UNIT PACKAGE: 25



**22050**  
(Subaru: 91059FC041)  
Gray Nylon

Moulding Clip  
Top Head Size: 11mm x 15mm  
Bottom Head Size: 14mm x 22.5mm  
Stem Length: 13mm  
Overall Height: 24mm  
Forester 2005 - 1998

UNIT PACKAGE: 25



**21562**  
(91017FA080)  
Gray Nylon

Grille Clip  
Overall Height: 27mm  
Forester Impreza & SVX 2008 - 1993

UNIT PACKAGE: 25



**21579**  
(91167AA000)  
Black Nylon

Cowl Top, Quarter Glass, Exterior Trim,  
Belt Moulding, Trunk Lid &  
Rear Light Grommet with Sealer  
Head Diameter: 17.5mm  
Stem Length: 15mm  
Fits into 8mm Hole  
Baja, Forester, Impreza, Legacy,  
Outback & SVX 2006 - 1991

UNIT PACKAGE: 25



**21587**  
(62731FA010)  
Blue Nylon

Screw Size: M3.5 (#6)  
Head Size: 11mm x 11mm  
Stem Length: 10mm  
Fits into 8mm x 8mm Square Hole  
Subaru 1993 - On

UNIT PACKAGE: 25



**21629**  
(62731FA000)  
White Nylon

Screw Size: M3.5 (#6)  
Head Size: 10mm x 10mm  
Stem Length: 5mm  
Fits into 7mm x 7mm Hole  
Forester, Impreza, Legacy &  
Outback 2009 - 05

UNIT PACKAGE: 25



**22044**  
(Subaru: 661179000, 909300007)  
Yellow Nylon

Nylon Nut  
Screw Size: M4.8 (#10)  
Head Size: 14mm x 14mm  
Stem Length: 7mm  
Forester, Impreza, Justy, Legacy,  
Outback, SVX, Tribeca & XV 1987 - On

UNIT PACKAGE: 25



**21575**  
(94081FA010)  
White Nylon

Screw Grommet  
Screw Size: M4.8 (#10)  
Head Diameter: 13mm  
Stem Length: 8mm  
Fits into 8mm Square Hole  
Subaru 1992 - On

UNIT PACKAGE: 25



**21569**  
(909300015)  
White Nylon

Rear Bumper Screw Grommet  
Screw Size: M4.8 (#10)  
Head Diameter: 12mm  
Stem Length: 15mm  
Fits into 7mm Square Hole  
Impreza, Legacy, Outback & SVX 2009 - 1995

UNIT PACKAGE: 25



**21577**  
(57750FC010)  
White Nylon

Rear Bumper Reinforcement Beam  
Screw Grommet with Sealer  
Screw Size: M4.8 (#10)  
Head Size: 16mm x 16mm  
Stem Length: 19mm  
Forester 2008 - 1998

UNIT PACKAGE: 25



## 22043

(Subaru: 91084AA010)  
White Nylon

Screw Grommet with Sealer  
Screw Size: M5.5 (#12)  
Head Diameter: 20mm  
Stem Length: 18mm  
Forester, Impreza, Legacy,  
Outback & Tribeca 1995 - On

UNIT PACKAGE: 15



## 21589

(99045AE03AMA)  
Black Nylon

Trim Panel Retainer  
Head Diameter: 18mm  
Stem Diameter: 7.7mm  
Stem Length: 15mm  
B9 Tribeca, Impreza, Legacy  
& Outback 2005 - On

UNIT PACKAGE: 25



## 21590

(91486KJ000)  
White Nylon

Cowl & Dash Grommet  
Head Diameter: 14mm  
Stem Length: 7mm  
Fits into 7mm Hole

**Use with Auveco 21531**

Forester, Impreza, Legacy & Outback 2008 - On

UNIT PACKAGE: 25



## 22211

(Subaru: 909207031)  
Black Nylon

Hood Insulation Retainer  
Head Diameter: 23mm  
Stem Diameter: 8mm  
Stem Length: 15mm  
Subaru BRZ, Forester, Impreza,  
WRX & XV Crosstrek 2012 - On

UNIT PACKAGE: 50



## 21531

(91486KJ010)  
Black Nylon

Cowl Panel Vent Cap  
Top Head Size: 16mm x 18mm  
Bottom Head Diameter: 14mm  
Stem Length: 12mm  
**Use with Auveco 21590**  
Forester, Impreza, Legacy, Outback  
& WRX 2008 - On

UNIT PACKAGE: 15



## 21630

(95022AC040ML)  
Black Nylon

Headliner & Trim Space Retainer  
Head Diameter: 20mm  
Stem Diameter: 6mm  
Stem Length: 22mm  
Forester, Impreza, Legacy  
& Outback 1998 - On

UNIT PACKAGE: 25



## 21573

(90331GA090)  
Black Nylon

Weatherstrip Retaining Clip  
Head Diameter: 9mm  
Stem Diameter: 6.5mm  
Stem Length: 13mm  
Forester & Legacy 2008 - 1990

UNIT PACKAGE: 25



## 21322

(90814FC001)  
Black Nylon

Retainer  
Head Diameter: 30mm  
Stem Diameter: 6.5mm  
Stem Length: 13mm  
Subaru 1998 - On

UNIT PACKAGE: 10



## 22046

(Subaru: 91167FA010)  
Black Nylon

Front Hood Cowl Retaining Clip  
Head Size: 9.3mm x 14.5mm  
Stem Diameter: 7mm  
Stem Length: 16mm  
Impreza 2001 - 1993

UNIT PACKAGE: 25



## 21421

(909130074)  
Black Nylon

Hood Insulation Retainer  
Head Diameter: 30mm  
Stem Diameter: 7.7mm  
Stem Length: 13mm  
Baja, Forester, Impreza,  
Legacy, Outback & Tribeca 1998 - On

UNIT PACKAGE: 15



**22290**

(Subaru: 909130118)  
Black Nylon

Moulding Retainer with Sealer  
Head Diameter: 24mm  
Stem Length: 16mm  
Overall Length: 19.3mm  
Subaru Impreza, Legacy &  
Outback 2005 - On

UNIT PACKAGE: 15



**21574**

(909130034)  
White Nylon

Door, Pillar, Rocker, Floor &  
Interior Trim Retainer  
Top Head Diameter: 13mm  
Middle Head Diameter: 16mm  
Bottom Head Diameter: 15mm  
Stem Diameter: 9.5mm  
Stem Length: 11mm

Baja, Forester, Legacy & Outback 2008 - 03

UNIT PACKAGE: 25



**21591**

(909130109)  
Black Nylon

Front & Rear Door, Fender, Quarter Panel  
and Rocker Panel Moulding Retainer  
Top Head Size: 11mm x 14mm  
Bottom Head Diameter: 17mm  
Stem Diameter: 9.7mm  
Stem Length: 12mm  
B9 Tribeca, Forester, Impreza,  
Legacy & Outback 2003 - On

UNIT PACKAGE: 25



**22343**

(Subaru: 909130096)  
Green Nylon

Cowl, Garnish, Headliner, Rocker,  
Pillar & Interior Trim Retainer  
Top Head Diameter: 13mm  
Middle Head Diameter: 16mm  
Bottom Head Diameter: 15mm  
Stem Diameter: 9.8mm  
Stem Length: 10mm

Subaru B9 Tribeca, BRZ, Forester, Impreza, Legacy,  
Outback, WRX & XV Crosstrek 2005 - On

UNIT PACKAGE: 25



**22207**

(Subaru: 909130088)  
Black Nylon

Fender, Rocker, Garnish, Pillar, Floor  
& Exterior Trim Retainer with Sealer  
Top Head Size: 11mm x 14mm  
Bottom Head Diameter: 17mm  
Stem Diameter: 9.7mm  
Stem Length: 12mm  
Subaru Forester, Impreza, Legacy,  
Outback, B9 Tribeca & WRX 2005 - On

UNIT PACKAGE: 25



**21502**

(909130213)  
White Nylon

Door Trim Panel Retainer with Sealer  
Top Head Diameter: 13mm  
Middle Head Diameter: 16mm  
Bottom Head Diameter: 15mm  
Stem Diameter: 9.5mm  
Stem Length: 14mm  
Legacy & Outback 2010 - On

UNIT PACKAGE: 10



**21567**

(909130007)  
Gray Nylon

Pillar & Door Moulding Trim  
and Rear Light Retainer with Sealer  
Top Head Size: 11mm x 15mm  
Bottom Head Diameter: 18mm  
Stem Diameter: 9.7mm  
Stem Length: 12mm  
B9 Tribeca, Forester, Impreza,  
Legacy & Outback 2005 - On

UNIT PACKAGE: 25



**22206**

(Subaru: 909130105)  
White Nylon

Front & Rear Door, Headliner, Interior Trim,  
Liftgate & Quarter Panel Retainer  
Top Head Diameter: 13mm  
Middle Head Diameter: 16mm  
Bottom Head Diameter: 15mm  
Stem Diameter: 9.6mm x 9.6mm  
Stem Length: 14mm  
Overall Length: 21mm  
Subaru BRZ, Forester, Impreza, Legacy,  
Outback, B9 Tribeca, WRX &  
XV Crosstrek 2002 - On

UNIT PACKAGE: 50



**21584**  
(693005370)  
White Nylon

Front Door & Lift Gate Trim Panel Retainer  
Top Head Diameter: 13mm  
Middle Head Diameter: 16mm  
Bottom Head Diameter: 18mm  
Stem Diameter: 9.3mm  
Stem Length: 10mm  
Impreza, Justy, Legacy & Outback 2007 - 1987

UNIT PACKAGE: 25



**22048**  
(Subaru: 94078FA080)  
White Nylon

Trim Panel Retainer  
Top Head Diameter: 13mm  
Middle Head Diameter: 16mm  
Bottom Head Diameter: 18mm  
Stem Diameter: 9mm x 9.5mm  
Stem Length: 11mm  
Overall Length: 16.5mm  
Forester, Impreza & XV Crosstrek 1994 - On

UNIT PACKAGE: 25



**21565**  
(90331AA050)  
White Nylon

Weatherstrip Retaining Clip  
Head Size: 5mm x 14mm  
Stem Diameter: 7mm  
Stem Length: 8.5mm  
Forester 2008 - 03

UNIT PACKAGE: 25



**21585**  
(909130003)  
Black Nylon

Upper Grille Push-Type Retainer  
Head Diameter: 9mm  
Stem Length: 7mm  
Fits into 4mm Hole  
Baja, Legacy & Outback 2006 - 2000

UNIT PACKAGE: 25



**22230**  
(Subaru: 909140059)  
Black Nylon

Front & Rear Bumper Push-Type Retainer  
Head Diameter: 10mm  
Stem Length: 8.5mm  
Fits into 5mm Hole  
Subaru Forester, Impreza, Legacy,  
Outback, WRX, XV Crosstrek 2008 - On

UNIT PACKAGE: 15



**21593**  
(46064AE000)  
Black Nylon

Front Fender Bumper &  
Quarter Panel Push-Type Retainer  
Head Diameter: 15mm  
Stem Length: 8mm  
Fits into 7mm Hole  
Baja, Forester, Impreza,  
Legacy & Outback 2003 - On

UNIT PACKAGE: 10



**22160**  
(Subaru: 909140062)  
Black Nylon

Front & Rear Bumper  
Push-Type Retainer  
Head Diameter: 15mm  
Stem Length: 10mm  
Fits into 7mm Hole  
Subaru BRZ, Forester, Impreza &  
XV Crosstrek 2008 - On

UNIT PACKAGE: 15



**21658**  
(Mitsubishi: MR288150;  
Subaru: 909130013)  
Black Nylon

Push-Type Retainer  
Head Diameter: 15mm  
Stem Length: 11mm  
Fits into 6mm Hole  
Mitsubishi Endeavor, Galant, Lancer,  
Mirage, Montero & Outlander 1997 - On  
Subaru BRZ, Forester, Impreza, Legacy,  
Outback, & XV Crosstrek 2004 - On

UNIT PACKAGE: 10



**21570**  
(909140012)  
Black Nylon

Rear Light Reflector  
& Roof Spoiler  
Push-Type Retainer  
Head Diameter: 16mm  
Stem Length: 11mm  
Fits into 6mm Hole  
B9 Tribeca, Impreza,  
Legacy & Outback 2005 - On

UNIT PACKAGE: 25





**21566**  
(91085TA030)  
Black Nylon

Push-Type Retainer  
Head Diameter: 16mm  
Stem Length: 13mm  
Fits into 7mm Hole

Baja, Impreza, Legacy & Outback 2000 - On

UNIT PACKAGE: 25



**21530**  
(Subaru: 909130067;  
Hyundai: 86590-3S000)  
Black Nylon

Engine Cover and Fender Liner  
Push-Type Retainer  
Head Diameter: 18mm  
Stem Length: 10mm  
Fits into 8mm Hole

B9 Tribeca, Forester, Legacy &  
Outback & Tribeca. 2005 - On  
Hyundai Azera, Elantra, Genesis &  
Sonata and Kia Cadenza & Optima 2011 - On

UNIT PACKAGE: 15



**22181**  
(Subaru: 909140065)  
Black Nylon

Front Fender Liner, Engine Cover,  
Hood & Quarter Panel Push-Type Retainer  
Head Diameter: 18mm  
Stem Length: 10mm  
Fits into 8mm Hole

Subaru BRZ, Crosstrek, Forester, Impreza,  
Legacy, Outback & WRX 2008 - On

UNIT PACKAGE: 15



**21422**  
(909140051)  
Black Nylon

Front Bumper & Quarter Panel  
Push-Type Retainer  
Head Diameter: 20mm  
Stem Length: 9mm  
Fits into 7mm Hole

B9 Tribeca, Impreza, Legacy & Outback 2005 - On

UNIT PACKAGE: 15



**21571**  
(59122FA010)  
Black Nylon

Front Bumper, Fender, Windshield Washer  
& Rocker Moulding Push-Type Retainer  
Head Diameter: 20mm  
Stem Length: 10mm  
Fits into 8mm Hole

B9 Tribeca, Baja, Forester,  
Impreza, Legacy & Outback 1998 - On

UNIT PACKAGE: 25



**22270**  
(Subaru: 909140068)  
Black Nylon

Front Fender Push-Type Retainer  
Head Diameter: 20mm  
Stem Length: 10mm  
Fits into 8mm Hole

Subaru BRZ, Impreza, Legacy,  
Outback & XV Crosstrek 2012 - On

UNIT PACKAGE: 15



**21592**  
(909140052)  
Black Nylon

Push-Type Retainer  
Head Diameter: 20mm  
Stem Length: 11mm  
Fits into 7mm Hole

B9 Tribeca, Impreza, Legacy  
& Outback 2005 - On

UNIT PACKAGE: 15



**21594**  
(909130051)  
Black Nylon

Fender Liner, Duct &  
Lower Moulding Push-Type Retainer  
Head Diameter: 20mm  
Stem Length: 11mm  
Fits into 7mm Hole

B9 Tribeca, Forester, Impreza,  
Legacy & Outback 2005 - On

UNIT PACKAGE: 15



**21580**  
(59122AC030)  
Black Nylon

Front Fender Push-Type Retainer  
Head Diameter: 20mm  
Stem Length: 12mm  
Fits into 7mm Hole

B9 Tribeca, Baja, Forester,  
Legacy & Outback 1995 - On

UNIT PACKAGE: 25



**21500**  
(909140063)  
Black Nylon

Cowl Vent Push-Type Retainer  
Head Diameter: 20mm  
Stem Length: 12mm  
Fits into 7mm Hole

Legacy & Outback 2010 - On

UNIT PACKAGE: 10



## 21563

(909130059)  
Black Nylon

Front Bumper & Fender  
Push-Type Retainer  
Head Diameter: 20mm  
Stem Length: 15mm  
Fits into 10mm Hole

Forester, Impreza, & Outback 2006 - 02

UNIT PACKAGE: 25



## 21420

(909140007)  
Black Nylon

Bumper, Engine Cover, Fender  
& Grille Push-Type Retainer  
Head Diameter: 21mm  
Stem Length: 15mm  
Fits into 10mm

B9 Tribeca, Baja, Forester, Impreza,  
Legacy & Outback 2000 - On

UNIT PACKAGE: 15



## 21578

(57750AA090)  
Black Nylon

Front & Rear Bumper  
Push-Type Retainer  
Head Diameter: 22mm  
Stem Length: 28mm  
Fits into 10mm Hole  
Impreza & Legacy 2001 - 1993

UNIT PACKAGE: 25



## 21501

(909140055)  
Black Nylon

Push-Type Retainer with Sealer  
Head Diameter: 25mm  
Shoulder Length: 3mm  
Shoulder Diameter: 16.5mm  
Stem Length: 12mm  
Fits into 11mm Hole  
Subaru 2006 - On

UNIT PACKAGE: 5



## 21576

(909140002)  
Black Nylon

Rocker, Pillar, Floor & Exterior Trim  
Push-Type Retainer with Sealer  
Head Diameter: 25mm  
Shoulder Diameter: 17mm  
Shoulder Length: 3mm  
Stem Length: 14mm  
Fits into 11mm Hole

B9 Tribeca, Baja, Legacy & Outback 2000 - On

UNIT PACKAGE: 25



## 22047

(Subaru: 94415FA000NE)  
Gray & Black Nylon

Rear Roof Spoiler Trim  
Push-Type Retainer  
Top Head Diameter: 25mm  
Bottom Head Diameter: 21mm  
Stem Length: 9mm (Excluding the Pin)  
Fits into 8mm Hole  
Impreza 2007 - 1998

UNIT PACKAGE: 15



## 21568

(57160FC000)  
Black Nylon

Front Fender  
Push-Type Retainer  
Top Head Length: 19.5mm  
Bottom Head Diameter: 14mm  
Stem Length: 15mm  
Fits into 10mm Hole  
Forester 2008 - 1998

UNIT PACKAGE: 25



## 22210

(Subaru: 57371GA070)  
Natural Nylon

Tube/Cable Routing Clip  
Holds 5mm Diameter Tube/Cable  
Snaps into 6mm Hole  
Overall Height: 15mm  
Subaru BRZ, Forester, Impreza, Legacy,  
Outback, B9 Tribeca & WRX 1995 - On

UNIT PACKAGE: 25



## 22175

(Subaru: 91086AA000)  
Black Nylon

Splash Guard Nylon U-Nut  
with Metal Insert Nut  
Thread: M5-.80  
(Internal Steel Nut)  
Panel Range: Up to 3mm  
Center of Hole to Edge: 10mm  
Subaru 2008 - On

UNIT PACKAGE: 10



**22078**

(Suzuki: 83942-65D00)  
White Nylon

Liftgate, Exterior Trim &  
Garnish Moulding Clip  
Top Head Size: 9mm x 10mm  
Middle Head Diameter: 12mm  
Bottom Head Diameter: 15mm  
Stem Length: 11mm  
Fits into 9mm Hole

Suzuki Grand Vitara & XL7 2006 - 1999

UNIT PACKAGE: 25



**17383**

(GM: 94847334, 96057847;  
Toyota: 90467-07066;  
Suzuki: 09409-07313)  
Black Nylon

Radiator Grille & Trim Panel  
Push-Type Retainer  
Head Diameter: 11mm  
Stem Length: 14mm (Excluding the Pin)  
Fits into 7mm Hole

Suzuki and Geo Tracker & Prizm 1992 - 89

UNIT PACKAGE: 10



**20743**

(77553-65D00)  
White Nylon

Moulding Clip  
Head Diameter: 18mm  
Stem Length: 9mm  
Overall Length: 18mm  
Suzuki



UNIT PACKAGE: 10



**22083**

(Suzuki: 09409-08327)  
Black Nylon

Front Lights, Cowl &  
Rear Bumper Push-Type Retainer  
Head Diameter: 16mm  
Stem Length: 10mm  
Fits into 8mm Hole

Suzuki Kizashi, SX4 & XL7 2013 - 02

UNIT PACKAGE: 15



**22079**

(Suzuki: 77553-65D10)  
White Nylon

Moulding Clip  
Head Diameter: 18mm  
Stem Length: 9mm  
Overall Height: 18mm  
Suzuki Grand Vitara,  
Swift & XL7 1990 - On

UNIT PACKAGE: 15



**20908**

(Suzuki: 09409-07332;  
Toyota: 90467-07164)  
Black Nylon

Push-Type Retainer  
Head Diameter: 20mm  
Stem Length: 10mm  
Fits into 7mm Hole  
Suzuki 1999 - On  
Toyota 1997 - On

UNIT PACKAGE: 10



**20744**

(77259-71B00)  
White Nylon

Moulding Clip with Sealer  
Top Head Diameter: 13mm  
Bottom Head Diameter: 16mm  
Stem Length: 13mm  
Suzuki

UNIT PACKAGE: 10



**21691**

(Suzuki: 09409-06309-5ES)  
Black Nylon

Hood Insulation Retainer  
Head Diameter: 24mm  
Stem Diameter: 6mm x 6mm  
Stem Length: 13mm  
Grand Vitara, Swift & XL7 1990 - On

UNIT PACKAGE: 25



**21745**

(GM: 11609651)  
Zinc

Windshield Garnish and Interior Trim  
Moulding Fastener  
Screw Size: M4.2 (#8)  
Stem Width: 13mm  
Head Size: 13.5mm x 20.5mm  
Overall Length: 22mm  
Buick Enclave & Encore; Cadillac CTS, Escalade,  
STS & XTS; Chevrolet Avalanche, Camaro, Cobalt,  
Corvette, HHR, Impala, Malibu, Monte Carlo,  
Silverado, Suburban, Tahoe & Traverse; Dodge Truck;  
Ford Flex & Taurus; GMC Sierra & Yukon; Kia Sorento  
& Soul; Pontiac G6 & G8; Saturn Outlook  
and Suzuki Grand Vitara 2004 - On

UNIT PACKAGE: 15



**16691**

Natural Nylon

Headlight Adjusting  
Screw Nut  
Pick-Up Truck 1984-On

UNIT PACKAGE: 25



**18747**

(90189-06162)  
Natural Nylon

Front Clearance Lamp Nut  
Camry 1994-91  
Headlight Adjusting Nut  
Lexus

UNIT PACKAGE: 10



**16951**

(81124-89101)  
Nylon

Headlight Spacer  
Width: 15mm  
Length: 18mm  
Fits into 7mm Square Hole  
Pick-Up Truck 1984-On

UNIT PACKAGE: 25

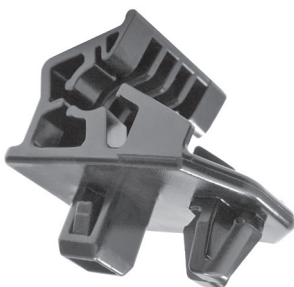

**20738**

(53271-44010)  
Black Nylon

Headlight Bracket Clip  
Width: 25mm  
Length: 40.5mm  
Toyota Camry & RAV4  
and Lexus IS-300 2001 - On

UNIT PACKAGE: 4

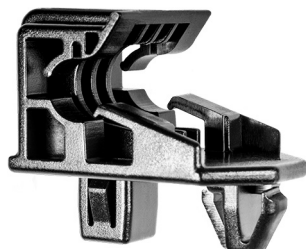

**22102**

(Toyota: 53271-12040;  
53271-12060; 53271-0B010)  
Black Nylon

Headlight Bracket Clip  
Width: 25mm  
Length: 39mm  
Overall Height: 33mm  
Lexus GX460, GX470, RX 300, RX 330 & RX 350  
and Toyota Corolla, Echo, Highlander, MR2, Prius,  
Tacoma, Tercel & 4-Runner 1993 - On

UNIT PACKAGE: 10



**21369**

(67771-58010)  
White Nylon

Door & Garnish Moulding Clip  
Overall Height: 12.4mm (1/2")  
Tundra 2007 - On

UNIT PACKAGE: 25



**21546**

(90467-09204)  
White Nylon

Rear Hatch Door Side Garnish  
and Front Body Pillar Garnish  
Moulding Clip  
Overall Height: 14mm  
Toyota Camry, Highlander, Prius & Sienna and  
Lexus GS 300, GS 400, GS 430, GX 470, RX 330,  
RX 350, RX 400 & RX 450 1998 - On

UNIT PACKAGE: 25



**21549**

(90467-12080)  
Pink Nylon

Door Trim, Instrument Panel,  
Rear Deck Trim & Roof Garnish Trim  
Moulding Clip  
Overall Height: 21mm  
Toyota Avalon, Camry, Corolla, Echo, FJ Cruiser,  
Highlander, Matrix, Prius, RAV4, Sequoia, Sienna,  
Tacoma, Tundra, Venza, Yaris & 4-Runner and  
Lexus ES 350, GX 460, RX 330 & RX 450h 2000 - On

UNIT PACKAGE: 25



**17194**

(90467-13005)  
Black Nylon

Grille Clip  
Width: 13mm  
Length: 23mm

UNIT PACKAGE: 25



**21623**

(Mitsubishi: MR221507;  
Toyota: 90467-13075)  
Gray Nylon

Radiator Grille Clip  
Width: 14mm  
Length: 24mm  
Mitsubishi Diamante, Endeavor & Galant 1997 - On  
Toyota 4 Runner, Highlander & Land Cruiser 1998 - On

UNIT PACKAGE: 25





**17438**  
(90467-17004)  
Black Nylon

Radiator Grille Clip  
Width: 21mm  
Length: 22mm  
Cressida 1987-84

UNIT PACKAGE: 10



**19430**  
(90904-67021)  
Black Nylon

Radiator Grille Retainer  
T-100 Truck 1992-On

UNIT PACKAGE: 15



**22163**  
(Toyota: 53145-12010)  
Black Nylon

Grille Clip  
Overall Length: 38mm  
Toyota Corolla, FJ Cruiser  
& Tacoma 1993 - On

UNIT PACKAGE: 15



**21194**  
(61118-35010)  
Black Nylon

Front Fender Upper Seal  
Moulding Clip  
Head Size: 18mm x 18mm  
Stem Length: 13mm  
Fits into 9mm Hole  
FJ Cruiser 2007 - On

UNIT PACKAGE: 15



**22351**  
(Toyota: 90467-10181)  
Black Nylon

Headliner & Interior Trim Moulding Clip  
Top Head Size: 18mm x 19mm  
Bottom Head Size: 18mm x 24mm  
Stem Diameter: 10mm  
Stem Length: 13mm  
Lexus ES 300h/350,  
GS 300/350/430/460,  
IS 200T/250/300/350, NX 200T/300h,  
RC 200T/300/350 & RX 350/400h/450h and  
Toyota Avalon & Camry 1998 - On

UNIT PACKAGE: 25



**22346**  
(Toyota: 53857-12010)  
Black Nylon



Front Fender Moulding Clip with Sealer  
Head Size: 20mm x 30mm  
Stem Diameter: 9mm  
Stem Length: 10mm  
Lexus NX 200t, NX 300h, Scion iM and  
Toyota Corolla & Prius 2015 - On

UNIT PACKAGE: 15



**21684**  
(Toyota: 81496-21010)  
Yellow Nylon

Rear Light Housing Guide with Sealer  
Top Head Diameter: 13mm  
Bottom Head Diameter: 20mm  
Stem Length: 10mm  
Toyota Prius 2012 - On

UNIT PACKAGE: 10



**15695**  
(Toyota: 62955-20020, 65955-12010;  
GM: 94848834)  
White Nylon

Moulding Clip with Sealer  
Head Diameter: 15mm  
Stem Length: 9mm  
Fits into 8mm Hole  
Toyota Pick-Up Truck and Pontiac Vibe

UNIT PACKAGE: 25



**21748**  
(Toyota: 75819-33010)  
White Nylon

Moulding Clip with Sealer  
Top Head Size: 8mm x 8mm  
Bottom Head Diameter: 15mm  
Stem Diameter: 10mm  
Stem Length: 14mm  
Lexus ES300 & ES330 & Scion and Toyota Camry,  
Corolla, Prius, Sequoia, Sienna & Tundra 2002 - On

UNIT PACKAGE: 25



**21453**  
(75395-0T010)  
White Nylon

Moulding Clip with Sealer  
Top Head Size: 5mm x 10mm  
Bottom Head Diameter: 18mm  
Stem Diameter: 10mm  
Stem Length: 13mm  
Corolla & Venza 2008 - On

UNIT PACKAGE: 25



**19647**

(90467-11111)  
Red Nylon

Scuff Plate Retainer  
Head Diameter: 18mm  
Stem Diameter: 10mm  
Stem Length: 10mm  
Sienna 1997-On

UNIT PACKAGE: 10



**20687**

(75396-35020, 75495-35010)  
Blue Nylon

Rocker Moulding Clip with Sealer  
Head Diameter: 17mm  
Stem Length: 10mm  
4-Runner 2003 - On

UNIT PACKAGE: 10



**17481**

(90467-11063)  
White Nylon

Rocker Panel  
Moulding Clip with Sealer  
Head Diameter: 18mm  
Stem Length: 9mm  
Previa 1990-On

UNIT PACKAGE: 15

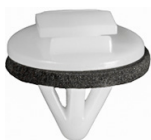

**21653**

(75867-AC020)  
White Nylon

Moulding Clip with Sealer  
Head Diameter: 18mm  
Stem Length: 13mm  
Fits into 8mm Hole  
Avalon 2005 - On

UNIT PACKAGE: 15



**20390**

(90904-67036)  
Blue Nylon

Fender Moulding Clip  
Head Diameter: 17mm  
Stem Length: 17mm  
Highlander, Land Cruiser,  
Tacoma & Tundra 2001 - On

UNIT PACKAGE: 10



**19797**

(90467-10077)  
Butterscotch Nylon

Door Moulding Clip with Sealer  
Head Diameter: 15mm  
Stem Length: 9mm  
Fits into 8mm Hole  
Avalon & Corolla 1998 - On

UNIT PACKAGE: 15



**20391**

(90904-67037)  
Red Nylon

Fender Moulding Clip  
Head Diameter: 17mm  
Stem Length: 13mm  
Highlander, Land Cruiser,  
Tacoma & Tundra 2001 - On

UNIT PACKAGE: 10



**22217**

(Toyota: 90467-08225)  
White Nylon

Moulding Clip with Sealer  
Top Head Size: 10mm x 10mm  
Bottom Head Diameter: 15mm  
Stem Diameter: 8mm x 8mm  
Stem Length: 8mm  
Toyota Corolla, Highlander & RAV4 2014 - On

UNIT PACKAGE: 25



**20688**

(75397-35010)  
Orange Nylon

Wheel Flare Moulding Clip with Sealer  
Head Diameter: 17mm  
Stem Length: 17mm  
4-Runner 2003 - On

UNIT PACKAGE: 10



**21550**

(90467-11099)  
White Nylon

Hood and Front &  
Rear Side Moulding Clip  
Head Diameter: 17mm  
Stem Length: 8.5mm  
Fits into 9mm Square Hole  
Tundra & 4-Runner 2006 - 1996

UNIT PACKAGE: 25



**20429**

(90467-11100)  
Yellow Nylon

Fender & Wheel Flare  
Moulding Clip  
Head Diameter: 17mm  
Stem Length: 17mm  
Highlander, Land Cruiser, Tacoma & Tundra 2000 - On

UNIT PACKAGE: 10



**21847**

(Toyota: 90467-08195)  
White Nylon

Front & Rear Fender Flare  
Moulding Clip with Sealer  
Head Size: 15mm x 22mm  
Stem Length: 13mm  
Overall Length: 21mm  
Lexus GX470 2009 - 03  
Toyota Land Cruiser 2007 - 1998

UNIT PACKAGE: 25



**21846**

(Toyota: 90467-08196)  
Yellow Nylon

Front & Rear Fender Flare and  
Mudguard Moulding Clip with Sealer  
Head Size: 16mm x 22mm  
Stem Length: 19mm  
Overall Length: 27mm  
Lexus GX470 2009 - 03  
Toyota Land Cruiser 2007 - 1998

UNIT PACKAGE: 25



**19843**

(75498-42010)  
White Nylon

Garnish Clip  
Head Diameter: 20mm  
Stem Length: 20mm  
RAV4 1996 - On

UNIT PACKAGE: 10



**21612**

(76817-12060)  
White Nylon

Rear Door, Hatch Garnish and  
Luggage Compartment  
Moulding Clip with Sealer  
Large Head Diameter: 24mm  
Overall Length: 24mm  
Camry, Corolla & Matrix 2003 - On

UNIT PACKAGE: 15



**22350**

(Toyota: 90467-A0004)  
White Nylon

Headliner & Interior Trim Moulding Clip  
Top Head Size: 14mm x 20mm  
Bottom Head Size: 18mm x 24mm  
Stem Diameter: 10mm  
Stem Length: 14mm  
Lexus RX 350 and Toyota  
Avalon & Camry 2005 - On

UNIT PACKAGE: 25



**22215**

(Toyota: 75397-42010)  
White Nylon

Moulding Clip with Sealer  
Top Head Size: 14.5mm x 17mm  
Bottom Head Size: 12mm x 18mm  
Stem Length: 9mm  
Toyota RAV4 2005 - 2001

UNIT PACKAGE: 25



**20578**

(GM: 88970495, 88973654;  
Toyota: 76924-52021)  
Black Nylon

Rocker Moulding Retainer  
Head Diameter: 32mm  
Stem Length: 10mm  
Fits into 22mm Hole  
Pontiac Vibe & Toyota Corolla 2003 - On

UNIT PACKAGE: 25



**14264**

(75395-14020-A)  
Nylon

Moulding Clip  
Width: 28mm  
Length: 14mm  
Snaps into 7mm Hole

UNIT PACKAGE: 25



**21071**

(90084-46020)  
White Nylon

Bumper Cover Clip  
Head Size: 21mm x 30mm  
Stem Length: 12mm  
Camry 2005 - On

UNIT PACKAGE: 10



**21641**

(90467-12073)  
White Nylon

Rocker Moulding Clip  
Head Size: 23mm x 28mm  
Stem Length: 14mm  
Fits into 10mm x 10mm Hole  
Land Cruiser 2007 - 1998

UNIT PACKAGE: 15



**19380**

(68211-07010)  
Natural Nylon

Door Belt Moulding Clip  
Avalon 1994-On

UNIT PACKAGE: 25



### 21712

(Toyota: 52535-0E030)  
White Nylon

Moulding Clip  
Top Head Size: 13mm x 13mm  
Stem Length: 22mm  
Overall Length: 25mm  
Lexus LS 600h & RX 450h  
and Toyota RAV4 & 4Runner 2006 - On

UNIT PACKAGE: 15



### 21857

(Toyota: 75392-35220)  
White Nylon

Front & Rear Spoiler Moulding Clip  
Head Size: 10mm x 20mm  
Stem Length: 24mm  
Overall Length: 27mm  
Lexus HS250 & RX350 and Toyota  
Camry, Corolla, FJ Cruiser &  
Highlander 2010 - On

UNIT PACKAGE: 25



### 21016

(75392-35200, 75392-04010)  
Blue Nylon

Fender Flare & Bumper Clip  
Head Size: 13mm x 26mm  
Stem Length: 24mm  
Toyota Camry, FJ,  
RAV4 & Tacoma 2005 - On

UNIT PACKAGE: 15



### 21586

(76853-10010)  
White Nylon

Front & Rear Bumper Clip  
Head Size: 13mm x 26mm  
Stem Length: 25mm  
Matrix 2008 - 03

UNIT PACKAGE: 25



### 22158

(Toyota: 62217-33031)  
Black Nylon

Windshield Pillar Trim Clip  
Overall Length: 43mm  
Stem Size: 7mm x 12mm  
Stem Length: 12mm  
Toyota Camry 2011 - 2007

UNIT PACKAGE: 15

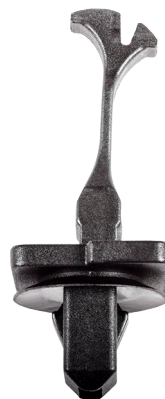

### 22159

(Toyota: 90950-08004)  
Black Nylon

Roof Garnish &  
Front Pillar Post Trim Clip  
Overall Length: 51mm  
Stem Size: 7mm x 12mm  
Stem Length: 12mm  
Toyota Camry, Corolla, Highlander,  
Land Cruiser, Matrix &  
RAV4 2013 - 2004

UNIT PACKAGE: 15



### 21642

(90467-12075)  
Yellow Nylon

Rocker Moulding Clip  
Top Head Size: 11mm x 13mm  
Bottom Head Size: 15mm x 25mm  
Stem Length: 14mm  
Fits into 10mm x 10mm Hole  
Land Cruiser 2007 - 1998

UNIT PACKAGE: 15

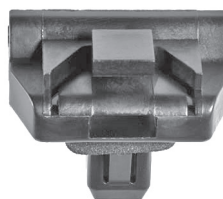

### 21133

(52197-52010)  
Black Nylon

Front Bumper  
Moulding Clip with Sealer  
Overall Width: 30mm  
Overall Height: 25mm  
Stem Length: 13mm  
Highlander 2001 - On

UNIT PACKAGE: 10

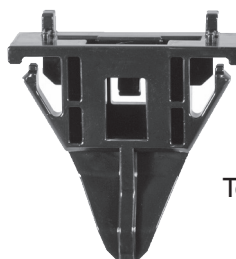

### 21234

(61991-35010)  
Black Nylon

Front Fender/Sheet Metal  
Upper Seal Moulding Clip  
Top Head Size: 9mm x 31mm  
Overall Height: 30mm  
FJ Cruiser 2007 - On

UNIT PACKAGE: 10

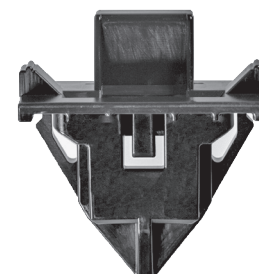

### 21235

(61992-35010)  
Black Nylon

Front Fender/Sheet Metal  
Upper Seal Moulding Clip  
Top Head Size: 13mm x 31mm  
Overall Height: 34mm  
FJ Cruiser 2007 - On

UNIT PACKAGE: 10





**21132**  
(52115-48040)  
Gray Nylon

Front Bumper  
Moulding Clip  
Overall Length: 47mm  
Stem Length: 8mm  
Highlander 2001 - On

UNIT PACKAGE: 10



**21217**  
(76924-47010)  
Black Nylon

Rocker Panel  
Moulding Clip  
Head Size: 43mm x 54mm  
Overall Height: 26mm  
Prius 2009 - On

UNIT PACKAGE: 5



**21221**  
(52115-0C090)  
Black Nylon

Front Bumper Moulding Clip  
Head Size: 25mm x 74mm  
Overall Height: 17mm  
Stem Length: 15mm  
Tundra 2009 - On

UNIT PACKAGE: 10



**21162**  
(53935-35020)  
Black Nylon

Bumper Filler Clip  
Overall Length: 30mm  
Overall Height: 17mm  
4 Runner 2003 - On

UNIT PACKAGE: 10



**16800**

*Photo not actual size*

M6-1.0 x 20mm  
License Plate Hardware  
Includes Nylon Screw,  
Washer & Spacer and Brass Nut

UNIT PACKAGE: 25 Sets



**17636**  
Nylon

License Plate  
Bracket Spacer  
Inner Diameter: 1/4" (6mm)  
Outer Diameter: 3/4" (19mm)  
Thickness: 1/4" (6mm)

UNIT PACKAGE: 50



**19722**  
(68211-95D00)  
White Nylon

Door Glass Clip  
Previa Van 1990 - On

UNIT PACKAGE: 15



**16833**  
(75545-32020)  
Nylon

Windshield Moulding Clip  
Width: 12mm  
Length: 66mm  
Camry 1987-On

UNIT PACKAGE: 10



**19204**  
(75546-12060)  
Natural Nylon

Windshield Moulding Clip  
Corolla Sedan Wagon 1992-88

UNIT PACKAGE: 25

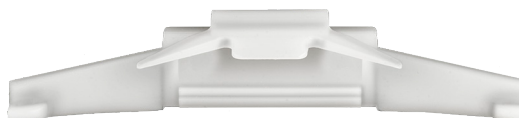

**17334**  
(75546-22060)  
Natural Nylon

Windshield Side Moulding Clip  
Cressida 1988-On

UNIT PACKAGE: 15





**14746**  
(75546-12050)  
Nylon

Windshield Moulding Clip  
Width: 20mm  
Length: 41mm  
Fits into 8mm Hole

UNIT PACKAGE: 15



**14751**  
(75545-16020)  
Nylon

Windshield Moulding Clip  
Width: 18mm  
Length: 49mm  
Height: 13mm

UNIT PACKAGE: 25

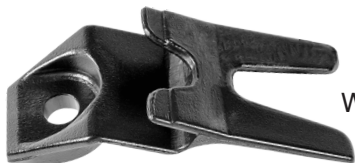

**17298**  
(75547-22010)  
Black Nylon

Windshield Moulding Clip  
Width: 20mm  
Length: 47mm  
1981-On

UNIT PACKAGE: 25



**14749**  
(75545-88080;  
75545-28010-B)  
Nylon

Windshield Moulding Clip  
Width: 18mm  
Length: 49mm  
Height: 16mm

UNIT PACKAGE: 25

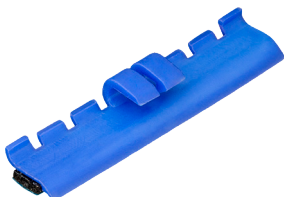

**19484**  
(75548-22150)  
Blue Nylon

Windshield Moulding Clip  
with Adhesive Backing  
Width: 9mm  
Length: 40mm  
Cressida 1988 - On

UNIT PACKAGE: 10



**14747**  
(75545-14081)  
Nylon

Windshield Moulding Clip  
Width: 18mm  
Length: 50mm  
Height: 15mm

UNIT PACKAGE: 25



**14745**  
(75546-22050)  
Nylon

Windshield Moulding Clip  
Width: 14mm  
Length: 47mm  
Height: 12mm

UNIT PACKAGE: 25



**16821**  
(75546-12030)  
Nylon

Windshield Moulding Clip  
Width: 21mm  
Length: 54mm  
Height: 15mm  
Corolla 1984-On

UNIT PACKAGE: 25

## WE WELCOME INQUIRES

If you have item suggestions  
please send them to  
[mail@auveco.com](mailto:mail@auveco.com)

or

go to [www.auveco.com](http://www.auveco.com) to  
submit your suggestions.



**16942**  
(75545-89101)  
Nylon

Windshield Moulding Clip  
Width: 15mm  
Length: 47mm  
Height: 13mm  
Pick-Up Truck 1984-On

UNIT PACKAGE: 15



**17224**  
(90189-04022, 95900-04036)  
Nylon

Screw Size: #6  
Width: 10mm  
Length: 10mm  
Snaps into 7mm x 7mm Hole

UNIT PACKAGE: 50



**14271**  
(90189-04011)  
Natural Nylon

Screw Size: #6  
Width: 12mm  
Length: 12mm  
Snaps into 7mm x 7.5mm Hole

UNIT PACKAGE: 25



**21628**  
(81137-22530, 90075-10004)  
White Nylon

Screw Size: M3.5 (#6)  
Head Size: 10mm x 10mm  
Stem Length: 7mm  
Fits into 7mm x 7mm Hole  
Avalon, Camry, Land Cruiser,  
Tacoma & Tundra 2007 - 1992

UNIT PACKAGE: 25



**22051**  
(Toyota: 90467-11117)  
White Nylon

Rear Trunk License Plate  
Trim Retaining Nut  
Screw Size: M3.5 (#6)  
Overall Height: 11.5mm  
Width at Bottom: 11mm  
Lexus & Toyota 2009 - 1998

UNIT PACKAGE: 15



**14256**  
(90189-04014)  
Natural Nylon

Screw Size: #8  
Width: 10mm  
Length: 10mm  
Snaps into 7mm x 7mm Hole

UNIT PACKAGE: 50



**13932**  
(Toyota: 90189-05013;  
Mitsubishi: MS-480002)  
Natural Nylon

Screw Size: #10  
Width: 12mm  
Length: 12mm  
Fits into 8mm x 9mm Hole

UNIT PACKAGE: 50



**14274**  
(Toyota: 90189-06010;  
Honda: 75521-611-000;  
Mazda: 9991-00-601;  
Nissan: 96706-P0105)  
Natural Nylon

Screw Size: #10  
Width: 13mm  
Length: 13mm  
Snaps into 8.5mm x 8.5mm Hole

UNIT PACKAGE: 25



**14258**  
(90189-06018)  
Black Nylon

Screw Size: #10  
Width: 14mm  
Length: 14mm  
Snaps into 9mm x 9mm Hole

UNIT PACKAGE: 25



**20895**  
(90189-06193)  
Natural Nylon

Front Bumper Nylon Nut  
Screw Size: M5.5 (#12)  
Head Size: 14mm x 16mm  
Stem Length: 10mm  
Avalon & Camry 2002 - On

UNIT PACKAGE: 25



**14739**  
(Toyota: 90189-05012;  
Isuzu: 8941340270)  
Natural Nylon

Screw Size: #6  
Width: 16mm  
Length: 12mm  
Snaps into 6mm x 10mm Hole

UNIT PACKAGE: 50



**20431**  
(90189-05105)  
Natural Nylon  
Front Fender Flare Screw Grommet  
Screw Size: M4.2 (#8)  
Head Size: 10mm x 15mm  
Stem Length: 12mm  
RAV4 1996 - On

UNIT PACKAGE: 15



## 21151

(90189-04059)  
White Nylon

Rocker, Pillar, Floor &  
Exterior Trim Screw Grommet  
Screw Size: M3.5 (#6)  
Head Size: 12mm x 18mm  
Stem Length: 7mm  
Toyota Scion, Avalon & FJ Cruiser  
and Lexus ES300, ES330, RX330,  
RX400, SC300, SC400 1992 - On

UNIT PACKAGE: 25



## 19840

(90189-04176)  
Natural Nylon

Mudguard Screw Grommet  
Screw Size: #8 (M4.2 - 1.41)  
Head Size: 10mm x 10mm  
Stem Length: 15mm  
Corolla 1997 - On

UNIT PACKAGE: 15



## 21544

(90189-04102)  
White Nylon

Screw Grommet with Sealer  
Screw Size: M3.2 (#6)  
Head Size: 10mm x 10mm  
Stem Length: 15mm  
Fits into 7mm Square Hole  
Toyota Highlander and  
Lexus IS 250, IS 350, & IS F 2006 - On

UNIT PACKAGE: 25



## 19783

(Ford: N811169-S, W705550-S300;  
Toyota: 90075-10801, 90189-06111)  
White Nylon

Head Diameter: 13mm  
Stem Length: 9mm  
Fits into 11mm Hole  
Ford, Lexus & Toyota

UNIT PACKAGE: 50



## 14277

(90189-04008, 90467-12096)  
Black Nylon

Screw Grommet  
Screw Size: #8  
Width: 12mm  
Length: 16mm  
Height: 15mm  
Fits into 10mm x 10mm Hole

UNIT PACKAGE: 15



## 18843

(90189-04031)  
Natural Nylon

Grille & Rear Filler Nut  
Screw Size: #8  
Camry & RAV4 2000 - 1991

UNIT PACKAGE: 25

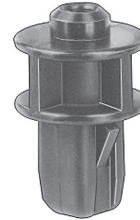

## 18846

(53145-16020)  
Black Nylon

Radiator Grille  
Garnish Grommet  
Tercel 1990 - On

UNIT PACKAGE: 10



## 14263

(90189-04019)  
Natural Nylon

Screw Size: #8  
Width: 12mm  
Length: 14mm  
Fits into 6.5mm x 8.5mm Hole

UNIT PACKAGE: 25



## 21015

(52535-50060, 52535-0E010)  
Black Nylon

Front Bumper Screw Grommet  
Screw Size: M5.5 - M6 (#12)  
Head Size: 17mm x 30mm  
Stem Length: 9mm  
Lexus IS250, IS350, RX330 & RX350 and  
Toyota Camry, Highlander & Tacoma 2001 - On

UNIT PACKAGE: 5



## 21583

(52535-30150)  
White Nylon

Front & Rear Bumper Screw Grommet  
Screw Size: M5.5 (#12)  
Head Size: 17.5mm x 30mm  
Stem Length: 10mm  
Toyota Avalon, Sequoia & Tundra and Lexus ES300,  
330, 350, LS430 & RX300 1999 - On

UNIT PACKAGE: 25



## 14265

(90189-06006)  
Natural Nylon

Screw Size: M4.8 (#10)  
Head Diameter: 17mm  
Fits into 9mm x 9mm Hole

UNIT PACKAGE: 25



**21331**

(90189-06211)  
Black Nylon

Pillar, Rocker and Floor  
Screw Grommet  
Screw Size: M5.5 (#12)  
Head Diameter: 17mm  
Stem Length: 10mm  
Fits into 9mm Square Hole  
Camry 2010 - On

UNIT PACKAGE: 25



**21191**

(90189-05142)  
Natural Nylon

Headlight Mounting Nylon Nut  
Screw Size: M4.2 (#8)  
Head Diameter: 17mm  
Stem Length: 8mm  
Fits into 9mm Square Hole  
Toyota & Scion 2001 - On

UNIT PACKAGE: 25



**19187**

(90189-05082)  
Natural Nylon

Hood Seal to Cowl Top  
Screw Grommet  
Screw Size: #6  
Head Diameter: 13mm  
Stem Length: 13mm  
Fits into 7mm x 7mm Hole  
2WD & 4WD Truck 1988-On

UNIT PACKAGE: 15



**14268**

(Toyota: 90189-04013;  
Honda: 90672-671-8110M1)  
Natural Nylon

Screw Size: #6  
Head Diameter: 14mm  
Stem Length: 15mm  
Fits into 7mm x 7mm Hole

UNIT PACKAGE: 25



**14695**

(Toyota: 90189-06042;  
Honda: 90661-SC7-003;  
Mazda: H001-50-841;  
Mitsubishi: MS-480012;  
Nissan: 01651-00481, 74798-S9000)  
White Nylon

Screw Grommet  
Screw Size: #8  
Head Diameter: 16mm  
Stem Length: 17mm  
Fits into 8mm x 8mm Hole

UNIT PACKAGE: 25



**14275**

(Toyota: 90189-06001;  
Mitsubishi: MB-098145;  
Nissan: 01281-00023, 01281-00231)  
White Nylon

Screw Grommet  
Screw Size: M4.8 (#10)  
Head Diameter: 18mm  
Stem Length: 17mm  
Fits into 8.5mm x 8.5mm Hole

UNIT PACKAGE: 25



**14281**

(Honda: 90662-693-003;  
Toyota: 90189-04066)  
White Nylon

Screw Grommet  
Screw Size: #6  
Head Diameter: 14mm  
Stem Length: 10mm  
Fits into 7mm x 7mm Hole

UNIT PACKAGE: 25



**19505**

(Toyota: 90189-06029,  
90189-06084, 90189-06116;  
Hyundai: 86910-22000)  
Natural Nylon

Rear Door Panel Screw Grommet  
Screw Size: #12  
Head Diameter: 18mm  
Stem Length: 17mm  
Fits into 9mm x 9mm Hole  
Camry & Previa 1988 - On  
Hyundai 1997 - On

UNIT PACKAGE: 10



**19742**

(90189-06104)  
Natural Nylon

Fender Lining Screw Grommet  
Screw Size: #12 (M5.5)  
Head Diameter: 18mm  
Stem Length: 15mm  
Fits into a 9mm Square Hole  
Lexus IS300 & Toyota Avalon,  
Camry & Sienna 1997-On

UNIT PACKAGE: 15



**21625**

(90189-06145)  
Black Nylon

Fender Lining Screw Grommet  
Screw Size: M5.5 (#12)  
Head Diameter: 16mm  
Stem Length: 16mm  
Fits into 9mm x 9mm Hole  
Toyota Prius, Sequoia & T-100  
and Lexus CT 200h 1993 - On

UNIT PACKAGE: 15





## 22213

(Toyota: 90189-06076)  
Natural Nylon

Screw Grommet  
Screw Size: M5.5 (#12)  
Head Diameter: 16mm  
Stem Length: 16mm  
Fits into 9mm x 9mm Square Hole  
Toyota Yaris and Scion xA & xD 2007 - On

UNIT PACKAGE: 25



## 20440

(90189-06065)  
Black Nylon

Hood & Fender Screw Grommet  
Screw Size: M5.5 (#12)  
Head Diameter: 20mm  
Stem Length: 18mm  
Fits into 9mm x 9mm Hole  
Camry & RAV4 1999 - 95

UNIT PACKAGE: 15



## 19194

(Toyota: 90189-06028; GM: 94854203)  
Black Nylon

Front & Rear Wheel  
Fender Liner Screw Grommet  
Screw Size: #12  
Head Diameter: 16mm  
Stem Length: 19mm  
Fits into 9mm x 9mm Hole  
Tacoma, T100 & 4 Runner 1992-On  
Chevrolet Nova & Prizm and Pontiac Vibe 1985-On

UNIT PACKAGE: 15



## 19721

(90189-06157)  
Black Nylon

Fender Lining Screw Grommet  
Screw Size: M5.5 (#12)  
Head Diameter: 20mm  
Stem Length: 22mm  
Fits into 8mm x 8mm Hole  
Avalon, Camry, RAV4, Solara  
& Tacoma 1995-On

UNIT PACKAGE: 15



## 19756

(90189-06214)  
Black Nylon

Fender Liner  
Screw Grommet  
Screw Size: #12 (M5.5)  
Head Diameter: 16mm  
Stem Length: 18mm  
Sienna, Tacoma & Tundra Pick-Up 1999 - On

UNIT PACKAGE: 15



## 21411

(90189-06177)  
Black Nylon

Rocker Moulding Screw Grommet  
Screw Size: M5.5. (#12)  
Head Diameter: 20mm  
Stem Length: 22mm  
Fits into 9mm x 9mm Hole  
Camry 2010 - On

UNIT PACKAGE: 15



## 21605

(90189-A0002)  
Black Nylon

Screw Grommet  
Screw Size: M5.5 (#12)  
Head Diameter: 20mm  
Stem Length: 17mm  
Fits into 9mm x 9mm Hole  
Toyota Avalon, Corolla, FJ Cruiser, RAV4,  
Sienna, Tacoma & 4Runner and Lexus  
GX460, GX470 & LX570 1995 - On

UNIT PACKAGE: 25



## 20412

(90189-06114)  
White Nylon

Front Fender Liner Screw Grommet  
Screw Size: M5.5 (#12)  
Head Diameter: 18mm  
Stem Length: 15mm  
Fits into 9mm Square Hole  
RAV4 1996 - On

UNIT PACKAGE: 15



## 21792

(Toyota: 90189-06236)  
Black Nylon

Fender Liner Screw Grommet  
Screw Size: M5.5 (#12)  
Head Diameter: 20mm  
Stem Length: 17mm  
Fits into 9mm x 9mm Hole  
Toyota Echo, RAV4  
Tacoma & Scion 2005 - On

UNIT PACKAGE: 25



## 14266

(90189-06003)  
Nylon

Screw Grommet  
Screw Size: #14 (1/4") or M6.3-1.81  
Head Diameter: 18mm  
Stem Length: 21mm  
Fits into 8mm x 8mm Hole

UNIT PACKAGE: 15





**14273**

(90189-06005)  
White Nylon

Screw Grommet  
Screw Size: #14 (1/4") or M6.3-1.81  
Head Diameter: 18mm  
Stem Length: 16mm  
Fits into 8mm x 8mm Hole  
Lexus & Toyota

UNIT PACKAGE: 50



**19534**

(90467-10152)  
Natural Nylon

Cowl Vent Grommet  
Flange Diameter: 18mm  
Stem Length: 16mm  
Fits into 9mm Hole  
**Use with Auveco 19535**  
Lexus ES300, Toyota Camry & Tercel 1995 - On

UNIT PACKAGE: 10



**14267**

(90189-06013)  
Black Nylon

Screw Grommet  
Screw Size: #14 (1/4") or M6.3-1.81  
Head Diameter: 20mm  
Stem Length: 17mm  
Fits into 8mm x 8mm Hole  
Lexus & Toyota

UNIT PACKAGE: 25



**19535**

(90467-07126)  
Black Nylon

Cowl Vent Pin Retainer  
Head Diameter: 16mm  
Stem Length: 17mm  
**Use with Auveco 19534**  
Lexus ES300, Toyota Camry & Tercel 1995 - On

UNIT PACKAGE: 10



**22197**

(Toyota: 52188-06030)  
Yellow Nylon

Rear Bumper Screw Grommet with Sealer  
Screw Size: M6 (#14)  
Head Diameter: 20mm  
Stem Length: 22mm  
Fits into 9mm x 9mm Square Hole  
Toyota Camry 2011 - 07

UNIT PACKAGE: 15

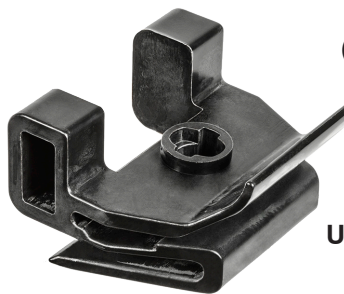

**21797**

(Toyota: 53879-30040)  
Black Nylon

Front Bumper  
Cover Clip  
Width: 32mm  
Length: 39mm  
**Use with Auveco 21357**  
Lexus CT200h &  
HS250h 2010 - On  
Toyota Camry 2012 - On

UNIT PACKAGE: 5



**22096**

(Toyota: 52197-22020)  
Black Nylon

Rear Bumper Side  
Bracket Screw Grommet with Sealer  
Screw Size: M6.3 (#14)  
Head Size: 16mm x 18mm  
Stem Length: 19mm  
Lexus ES 350 & HS 250h 2012 - 07  
Toyota Avalon & Camry 2012 - On

UNIT PACKAGE: 15



**20758**

(53879-58010)  
Black Nylon

Front Fender &  
Bumper Cover Clip  
Width: 25mm  
Length: 34mm  
**Use with Auveco 20757**  
Lexus and Toyota 4 Runner,  
Highlander, Sienna & Solara 2000 - On

UNIT PACKAGE: 5



**21237**

(53867-47020)  
Dark & Light Gray Nylon

Front Fender Retainer with Sealer  
Overall Height: 18mm  
Fits into 10mm x 16mm Hole  
Prius 2004 - On

UNIT PACKAGE: 10



**20757**

(47749-58010)  
Black Nylon

Front Fender & Bumper  
Cover Pin Retainer  
Head Diameter: 15mm  
Stem Length: 25mm  
**Use with Auveco 20758**  
Lexus and Toyota 4 Runner  
Highlander, Sienna & Solara 2000 - On

UNIT PACKAGE: 10



**22073**

(Toyota: 76924-47020)  
Black Nylon

Moulding Retainer  
Head Diameter: 32mm  
Stem Length: 12mm  
Fits into 22mm Hole  
Lexus CT 200h & Toyota Prius 2011 - On

UNIT PACKAGE: 15



**22166**

(Toyota: 76924-12030)  
Black Nylon

Rocker & Quarter  
Moulding Retainer  
Head Size: 28mm x 37mm  
Stem Length: 10mm  
Fits into 17mm x 22mm Hole  
Toyota Corolla 2014 - On  
Scion iQ 2014 - 2012

UNIT PACKAGE: 25

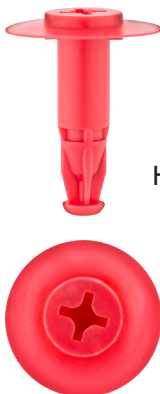

**22353**

(Toyota: 90467-09237)  
Red Nylon

Body Side Retainer  
Head Diameter: 20mm (with Phillips Drive)  
Stem Length: 24mm  
Overall Length: 26mm  
Lexus GS 200h, GS 350,  
GS 450h, IS 250, IS 350, RC 350,  
RX 350, RX 450h,  
Toyota Camry & Scion iM 2012 - On

UNIT PACKAGE: 25



**19014**

(90467-10123)  
Natural Nylon

Trim Panel Retainer  
Head Size: 11mm x 12mm  
Stem Length: 16mm  
Fits into 8mm Hole  
Celica 1993 - On

UNIT PACKAGE: 10



**19686**

(90467-05045-22)  
Black Nylon

Weatherstrip Retainer  
Head Diameter: 12mm  
Stem Diameter: 5mm Sq.  
Stem Length: 6mm  
Solara 1998-On

UNIT PACKAGE: 25



**19312**

(90467-05096-22)  
Black Nylon

Luggage Compartment  
Trim Panel Retainer  
Head Diameter: 16mm  
Stem Diameter: 5mm  
Stem Length: 13mm  
Tercel & Paseo 1994-On

UNIT PACKAGE: 25



**19643**

(90467-06175)  
Black Nylon

Luggage Compartment Retainer  
Head Diameter: 16mm  
Stem Diameter: 6mm  
Stem Length: 16mm  
Solara 1998-On

UNIT PACKAGE: 15



**20184**

(90467-08186)  
Black Nylon

Luggage Compartment Trim Retainer  
Head Diameter: 16mm  
Stem Diameter: 8mm  
Stem Length: 16mm  
Camry 1999 - On

UNIT PACKAGE: 25



**20878**

(90467-A0008)  
Black Nylon

Bumper Cover Retainer  
Head Diameter: 19mm  
Stem Diameter: 7.5mm  
Stem Length: 16mm  
Toyota, Lexus & Scion 1995 - On

UNIT PACKAGE: 50



**21253**

(90467-05164-B6)  
Gray Nylon

Headliner Retainer  
Head Diameter: 20mm  
Stem Diameter: 6mm  
Stem Length: 15mm  
Yaris 2009 - On

UNIT PACKAGE: 25



**21332**

(90467-05164-E2)  
Tan Nylon

Headliner Retainer  
Head Diameter: 20mm  
Stem Diameter: 6mm  
Stem Length: 15mm  
Corolla & Yaris 2009 - On

UNIT PACKAGE: 25



**19121**

(90467-08104)  
Gray Nylon

Roof Headliner Retainer  
Head Diameter: 20mm  
Stem Diameter: 8mm  
Stem Length: 20mm  
MR2 1990 - On

UNIT PACKAGE: 15



**22214**

(Lexus: 90467-06015-C0)  
Black Nylon

Front & Rear Bumper Retaining Clip  
Head Diameter: 7.5mm  
Stem Diameter: 5.5mm  
Stem Length: 10mm  
Lexus GS 300, GS 400 &  
GS 430 2005 - 1998

UNIT PACKAGE: 25



**21626**

(90467-06128)  
Black Nylon

Weatherstrip Retaining Clip  
Head Diameter: 12mm  
Stem Diameter: 6.5mm  
Stem Length: 11mm  
Camry & RAV4 1992 - On

UNIT PACKAGE: 25



**21296**

(90080-46010)  
Black Nylon

Hood Seal Retaining Clip  
Head Diameter: 13mm  
Stem Diameter: 7mm  
Stem Length: 10mm  
Camry 2010 - On

UNIT PACKAGE: 50



**18297**

(Toyota: 90467-08004, 90467-08011;  
GM: 94842841, 94849113)  
Black Nylon

Hood Seal Retaining Clip  
Head Diameter: 13mm  
Stem Length: 11mm  
Fits into 6mm Hole  
Lexus, Toyota, Geo Prizm & Nova 1985 - On

UNIT PACKAGE: 50



**14737**

(Toyota: 90467-07050, 90467-08008;  
Nissan: 01553-00172)  
Black Nylon

Retaining Clip  
Head Diameter: 13mm  
Stem Length: 15mm  
Panel Thickness: 3mm  
Fits into 5mm Hole

UNIT PACKAGE: 25



**21695**

(Toyota: 90467-08045, 90467-08063)  
Black Nylon

Hood & Weatherstrip Retaining Clip  
Head Diameter: 14mm  
Stem Diameter: 9mm  
Stem Length: 11mm  
Toyota Yaris 2007 - On

UNIT PACKAGE: 25



**22212**

(Toyota: 53145-60030)  
Black Nylon

Front Bumper, Grille & Hood Seal Retaining Clip  
Head Size: 4.3mm x 11mm  
Stem Diameter: 6.2mm  
Stem Length: 10mm  
Toyota Avalon, Camry, Highlander, Land Cruiser, Prius  
& Venza and Lexus GS 350, GS 450h, IS 250,  
IS 350, LX 570, NX 200t, NX 300h, RX 350 & RX 450h  
and Scion iQ & tC 2008 - On

UNIT PACKAGE: 100



**21643**

(90467-08101)  
Black Nylon

Hood to Cowl Top Seal  
Retaining Clip  
Head Size: 7mm x 13mm  
Stem Diameter: 7.5mm  
Stem Length: 13mm  
Toyota Camry, Sequoia, Solara  
& Tundra and Lexus ES 300 2006 - 1997

UNIT PACKAGE: 25



## 22001

(Toyota: 90467-08030)  
Black Nylon

Trim Retaining Clip  
Head Size: 9mm x 13mm  
Stem Diameter: 7.5mm  
Stem Length: 10mm  
Toyota

UNIT PACKAGE: 25



## 19124

(90467-07096)  
Black Nylon

Side Trim Panel Retaining Clip  
Head Diameter: 16mm  
Stem Length: 10mm  
Fits into 6mm Hole  
4WD Truck 1989-On

UNIT PACKAGE: 10



## 14736

(90467-06161-01)  
Black Nylon



Retaining Clip  
Head Diameter: 14mm  
Stem Length: 10mm  
Panel Thickness: 3mm  
Fits into 5mm Hole

UNIT PACKAGE: 25



## 16777

(Mazda: B001-68-302-00;  
Toyota: 90950-01248)  
Black Nylon

Retaining Clip  
Head Diameter: 15mm  
Stem Length: 15mm  
Panel Thickness: 2mm  
Fits into 8mm Hole

UNIT PACKAGE: 25



## 16781

(Honda: 90670-692-003;  
Toyota: 90467-09065)  
Black Nylon

Retaining Clip  
Head Diameter: 15mm  
Stem Length: 20mm  
Panel Thickness: 11mm  
Fits into 7mm Hole

UNIT PACKAGE: 25



## 14347

(Toyota: 90467-10018;  
Nissan: 01553-00202)  
Black Nylon

Retaining Clip  
Head Diameter: 18mm  
Stem Length: 12mm  
Panel Thickness: 4mm  
Toyota and Nissan  
Snaps into 7mm Hole

UNIT PACKAGE: 50



## 21634

(90467-10186)  
Black Nylon

Dash & Fender Apron  
Seal Retainer  
Head Diameter: 16.5mm  
Stem Diameter: 9mm  
Stem Length: 13mm  
Toyota 4 Runner, FJ Cruiser, Land Cruiser,  
RAV4, Sequoia, Tundra and Lexus GX 460,  
GX 470 & LX 470 1996 - On

UNIT PACKAGE: 25



## 22221

(Toyota: 90080-46327)  
Black Nylon

Fender Apron Seal Retainer  
Head Diameter: 17mm  
Stem Length: 15mm  
Fits into 7mm Hole

Toyota Sequoia, Tacoma & Tundra 2000 - On

UNIT PACKAGE: 50

## "428" DISPLAY BOARDS

428 of the most popular body hardware and fastener items are shrink-wrapped onto seven different boards. Each board contains product groups, body shops are familiar with and use often.

The back of each board contains each part number, unit package quantity, OEM number and size specification. The backs are protected by a clear plastic liner.

Learn more about the display boards at the front of the catalog, online at [www.auveco.com](http://www.auveco.com) or contact customer service at 1-800-354-9816 or [mail@auveco.com](mailto:mail@auveco.com)



**16779**  
(Honda: 74842-659-0030;  
Toyota: 90467-12078)  
Black Nylon

Retaining Clip  
Head Diameter: 18mm  
Stem Length: 15mm  
Panel Thickness: 6mm  
Fits into 8mm Hole

UNIT PACKAGE: 25



**19113**  
(90467-08124)  
Black Nylon

Hood Insulation Retainer  
Head Diameter: 25mm  
Stem Diameter: 8mm  
Stem Length: 12mm  
Supra 1993-On  
Lexus 1994-89

UNIT PACKAGE: 15



**19842**  
(75867-30110)  
Black Nylon

Rocker Panel Clip  
Head Diameter: 18mm  
Stem Length: 22mm  
Fits into 9mm Hole  
Corolla 1997 - On

UNIT PACKAGE: 15



**19729**  
(90467-09050)  
Black Nylon

Hood Insulation Retainer  
Head Diameter: 25mm  
Stem Length: 10mm  
Fits into 7mm Hole  
Lexus, Camry & Solara 1998-On

UNIT PACKAGE: 15



**22103**  
(Toyota: 53857-47011)  
Black Nylon

Front Fender  
Retainer with Sealer  
Head Diameter: 20mm  
Stem Diameter: 9mm  
Stem Length: 9mm  
Lexus CT 200h and Toyota Camry, Prius,  
RAV4, Yaris & 4-Runner 2010 - On

UNIT PACKAGE: 15



**18878**  
(90467-08081)  
Black Nylon

Hood Insulation Retainer  
Head Diameter: 30mm  
Stem Length: 16mm  
Fits into 6mm Hole  
Celica 1993-89

UNIT PACKAGE: 15



**21254**  
(90467-08136)  
Black Nylon

Fender Seal Retaining Clip  
Head Diameter: 20mm  
Stem Diameter: 8mm  
Stem Length: 8mm  
Snaps into 7mm Hole  
Yaris 2009 - On

UNIT PACKAGE: 25



**19112**  
(90467-09004)  
Black Nylon

Hood Insulation Retainer  
Head Diameter: 30mm  
Stem Diameter: 8mm  
Stem Length: 16mm  
Tacoma 1995-On

UNIT PACKAGE: 15



**21211**  
(53326-08010)  
Black Nylon

Hood Insulation Retaining Clip  
Head Diameter: 24mm  
Stem Length: 12mm  
Fits into 7mm Hole  
Sienna 2009 - On

UNIT PACKAGE: 25



**18842**  
(90467-09006)  
Black Nylon

Hood Insulation Retainer  
Head Diameter: 30mm  
Stem Length: 17mm  
Fits into 7mm Hole  
Avalon, Camry, Lexus 1988-On

UNIT PACKAGE: 15





**14738**

(90467-09008)  
Black Nylon

Retaining Clip  
Head Diameter: 30mm  
Stem Length: 17mm  
Panel Thickness: 6mm  
Fits into 7mm Hole

UNIT PACKAGE: 25



**19123**

(90467-10107)  
Black Nylon

Fender Apron Seal Clip  
Head Diameter: 17mm  
2WD & 4WD Truck 1988-On

UNIT PACKAGE: 10



**21627**

(67868-30030)  
Black Nylon

Door & Roof Rail Retainer  
Head Diameter: 9mm  
Stem Diameter: 5.3mm  
Stem Length: 8mm  
Toyota Camry, Corolla, Corona  
& Land Cruiser 1999 - 74  
Lexus HS 250h, IS 250, IS 350,  
RX 350 & 450h 2006 - On

UNIT PACKAGE: 25



**21548**

(67869-20030)  
Black Nylon

Weatherstrip Retainer  
Head Diameter: 10mm  
Stem Diameter: 6mm  
Stem Length: 10mm  
Toyota Camry, Celica, Corolla, Highlander, Matrix,  
MR-2, Prius, RAV4, Scion, Solara & Supra and  
Lexus IS 300 & SC 430 1990 - On

UNIT PACKAGE: 25



**22357**

(Toyota: 67869-22010)  
Black Nylon

Front Door Weatherstrip Retainer  
Head Diameter: 10mm  
Stem Diameter: 5.3mm  
Stem Length: 12.5mm  
Toyota Avalon & Camry 2013 - On

UNIT PACKAGE: 25



**21552**

(90467-04034)  
White Nylon

Weatherstrip Retainer  
Top Head Size: 5mm x 15mm  
Bottom Head Diameter: 9mm  
Stem Diameter: 6.5mm  
Stem Length: 4mm  
Toyota Avalon, Corolla, Highlander, Matrix, Prius,  
RAV4, Scion & Venza and Lexus CT 200h, HS 250h,  
IS F, IS 250, IS 350, LS 460, LS 600h, RX 350,  
RX 400h & RX 450h 2003 - On

UNIT PACKAGE: 25



**21707**

(Honda: 91563-SCV-003)  
(Toyota: 67867-52010, 67867-0D060)  
White Nylon

Weatherstrip Retainer  
Head Size: 5mm x 15mm  
Bottom Head Diameter: 6.5mm  
Stem Diameter: 7mm  
Stem Length: 8.5mm  
Acura TL and Honda Element  
Odyssey & Pilot 2003 - On  
Toyota Echo, Land Cruiser, Prius, Tacoma  
& Yaris and Lexus GS 450, GX 460  
& LX 430 and Scion xA & xD 2000 - On

UNIT PACKAGE: 25



**19749**

(67867-12150)  
White Nylon

Weatherstrip Retainer  
Head Size: 5mm x 15mm  
Stem Length: 10mm  
Fits into 6mm Hole  
Avalon 1995 - On

UNIT PACKAGE: 15



**18692**

(Mazda: G031-58-762;  
Toyota: 67868-89101, 67867-28030,  
67867-89103; Ford: E7GZ-6120586-B)  
Natural Nylon

Weatherstrip Retainer  
Head Size: 5mm x 15mm  
Stem Length: 10mm  
Fits into 5mm Hole  
4-Runner 1989-83  
Mazda 1996-On  
Ford

UNIT PACKAGE: 50



**20443**  
(67867-0C010)  
Black Nylon

Weatherstrip Retainer  
Head Size: 5mm x 15mm  
Stem Length: 10mm  
Fits into 6mm Hole  
Tundra 1999 - On

UNIT PACKAGE: 25



**19728**  
(90467-10146)  
Black Nylon

Cowl Panel Retainer  
Head Size: 8mm x 17mm  
Stem Length: 14mm  
Fits into 7mm Hole  
Sienna Van 1997 - On

UNIT PACKAGE: 25



**19720**  
(90467-06138)  
Black & White Nylon

Hood to Cowl Seal Retainer  
Head Size: 8mm x 17mm  
Stem Length: 16mm  
Fits into 7mm Hole  
Avalon & Camry 1994 - On

UNIT PACKAGE: 10



**21551**  
(67869-12050)  
Black Nylon

Weatherstrip Retainer  
Top Head Diameter: 9mm  
Bottom Head Diameter: 12mm  
Stem Diameter: 7mm  
Stem Length: 13mm  
Corolla & Prius 2007 - 01

UNIT PACKAGE: 25



**16778**  
(Mazda: 9927-40-822;  
Toyota: 62581-14020)  
Natural Nylon

Trim Panel Retainer  
Top Head Diameter: 14mm  
Bottom Head Diameter: 18.5mm  
Stem Diameter: 11.5mm  
Stem Length: 14mm  
Overall Length: 20mm

UNIT PACKAGE: 25



**20576**  
(GM: 88969790;  
Toyota: 75867-21010)  
Yellow Nylon

Fender Flare Retainer  
Top Head Size: 10mm x 13mm  
Bottom Head Size: 14mm x 18mm  
Stem Diameter: 8.5mm x 8.5mm  
Stem Length: 9mm  
Overall Length: 13.5mm  
Pontiac Vibe & Toyota Echo 2002 - On

UNIT PACKAGE: 25



**21226**  
(75867-02010)  
Black Nylon

Rocker Moulding Retainer  
Top Head Diameter: 13mm  
Bottom Head Diameter: 18mm  
Stem Diameter: 9mm  
Stem Length: 10mm  
Overall Length: 15.5mm  
Corolla 2009 - On

UNIT PACKAGE: 25



**18861**  
(90467-10162)  
White Nylon

Scuff Plate Retainer  
Top Head Diameter: 13mm  
Bottom Head Diameter: 18mm  
Stem Diameter: 8.5mm x 8.5mm  
Stem Length: 12mm  
Overall Length: 17mm  
Celica 1993-On

UNIT PACKAGE: 15



**22056**  
(Toyota: 75867-30130)  
White Nylon

Rocker Moulding Retainer with Sealer  
Top Head Diameter: 13mm  
Bottom Head Diameter: 18mm  
Stem Diameter: 8.5mm x 8.5mm  
Stem Length: 13mm  
Lexus CT 200h, ES 300h, ES 350, GS 300, GS 350, GS 430, GS 460, GS 450h, HS 250h, IS 250, IS 350, IS F, LS 460, LS 600h & LX 570 and Toyota Land Cruiser 2006 - On

UNIT PACKAGE: 25

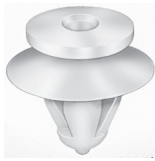

### 19719

(67921-32010)  
White Nylon

Scuff Plate Retainer  
Top Head Diameter: 13mm  
Bottom Head Diameter: 18mm  
Stem Diameter: 10mm  
Stem Length: 11mm  
Overall Length: 17.5mm  
Avalon, Camry & Corolla 1997 - On

UNIT PACKAGE: 15

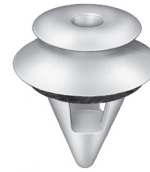

### 20473

(67771-12070)  
White Nylon

Door Panel & Rocker Moulding Retainer with Sealer  
Top Head Diameter: 13mm  
Bottom Head Diameter: 18mm  
Stem Diameter: 11mm  
Stem Length: 14mm  
Overall Length: 20mm  
Lexus SC300/400 Toyota Avalon & Corolla 1992 - On

UNIT PACKAGE: 15



### 21538

(75867-33030)  
Charcoal Nylon

Rocker Moulding Retainer  
Top Head Diameter: 13mm  
Bottom Head Diameter: 18mm  
Stem Diameter: 9.5mm  
Stem Length: 13mm  
Overall Length: 18.5mm  
Avalon, Camry, Prius, Scion, Sienna, Solara & Venza 2000 - On

UNIT PACKAGE: 25



### 21795

(Toyota: 67773-0E020)  
White Nylon

Door Panel Retainer with Sealer  
Top Head Diameter: 13mm  
Bottom Head (Including Sealer) Diameter: 18mm  
Overall Length: 20mm  
Fits into 8.5mm Hole  
Lexus RX350 2009 and Toyota Camry 2012 - On

UNIT PACKAGE: 25



### 21012

(75867-AA010)  
Black Nylon

Rocker Panel & Scuff Plate Retainer  
Top Head Diameter: 13mm  
Bottom Head Diameter: 18mm  
Stem Diameter: 9.5mm  
Stem Length: 14mm  
Overall Length: 18.5mm  
Lexus ES300 & ES330 2002 - On  
Toyota Avalon, Camry, Scion & Solara 2004 - On

UNIT PACKAGE: 15



### 22132

(Toyota: 53813-48011)  
Gray Nylon

Front Fender Retainer with Sealer  
Top Head Diameter: 20mm  
Bottom Head Diameter: 22mm  
Stem Length: 11mm  
Fits into 10mm Hole  
Lexus HS 250h, RX 350 & RX 450h and Toyota Prius & Sienna 2010 - On

UNIT PACKAGE: 10



### 18875

(67771-16170)  
White Nylon

Door Trim Panel Retainer  
Top Head Diameter: 13mm  
Bottom Head Diameter: 18mm  
Stem Diameter: 11mm  
Stem Length: 15mm  
Overall Length: 19.5mm  
Tercel 1991 - On

UNIT PACKAGE: 25



### 21686

(Toyota: 67771-32120)  
Green Nylon

Trim Panel Retainer with Sealer  
Top Head Size: 13mm x 16mm  
Middle Head Diameter: 16mm  
Bottom Head Diameter: 18mm  
Stem Diameter: 9mm  
Stem Length: 9mm  
Overall Length: 16.5mm  
Lexus ES 300, GS 300, GS 450h, IS F, IS 250, LS 460, LS 600hL, RX 350, Scion xA and Toyota Prius 2001 - On

UNIT PACKAGE: 25



**21410**  
(90467-09212)  
White Nylon

Cowl Trim Retainer  
Top Head Size: 13mm x 18mm  
Middle Head Diameter: 16mm  
Bottom Head Diameter: 18mm  
Stem Diameter: 10.7mm  
Stem Length: 12mm  
Overall Length: 16mm  
Camry 2010 - On

UNIT PACKAGE: 25



**19203**  
(67771-89104)  
Natural Nylon

Quarter Board  
Inside Trim Panel Retainer  
Top Head Diameter: 13mm  
Middle Head Diameter: 16mm  
Bottom Head Diameter: 18mm  
Stem Diameter: 11mm  
Stem Length: 11mm  
Overall Length: 18.5mm  
Truck 2WD 1997 - 1991

UNIT PACKAGE: 15



**20558**  
(62217-13010)  
White Nylon

Garnish Moulding Retainer  
Top Head Diameter: 13mm  
Middle Head Diameter: 16mm  
Bottom Head Diameter: 15mm  
Stem Diameter: 9mm x 9mm  
Stem Length: 11mm  
Overall Length: 17mm  
Lexus and Toyota Corolla,  
Matrix & 4 Runner 2003 - On

UNIT PACKAGE: 25



**14728**  
(67771-22020)  
Natural & Yellow Nylon

Door Panel Retainer  
Top Head Diameter: 12.5mm  
Middle Head Diameter: 16mm  
Bottom Head Diameter: 13mm  
Stem Diameter: 8.5mm  
Stem Length: 11mm  
Overall Length: 20mm

UNIT PACKAGE: 25



**19109**  
(67771-30070)  
Natural Nylon

Door Trim Panel & Garnish Retainer  
Top Head Diameter: 13mm  
Middle Head Diameter: 16mm  
Bottom Head Diameter: 15mm  
Stem Diameter: 9.5mm  
Stem Length: 11mm  
Overall Length: 18mm  
Corolla Wagon, Tercel,  
T-100 & Tacoma 2WD 1992-On

UNIT PACKAGE: 25



**18844**  
(67771-06010, 67771-32090)  
White Nylon

Trim Panel Retainer  
Top Head Diameter: 13mm  
Middle Head Diameter: 16mm  
Bottom Head Diameter: 18mm  
Stem Diameter: 10mm  
Stem Length: 13mm  
Overall Length: 20mm  
Cowl Side & Garnish Center Pillar Retainer  
Camry 1991-On

UNIT PACKAGE: 10



**20559**  
(GM: 88970345;  
Toyota: 90467-10167)  
Blue Nylon

Garnish Moulding Retainer  
Top Head Diameter: 13mm  
Middle Head Diameter: 16mm  
Bottom Head Diameter: 18mm  
Stem Diameter: 9mm x 9mm  
Stem Length: 11mm  
Overall Length: 18mm  
Pontiac Vibe, Lexus and Toyota 2000 - On

UNIT PACKAGE: 25



**18950**  
(90467-10168)  
Black & White Nylon

Garnish Retainer  
Top Head Diameter: 13mm  
Middle Head Diameter: 16mm  
Bottom Head Diameter: 18mm  
Stem Diameter: 10mm  
Stem Length: 13mm  
Overall Length: 20mm  
Avalon & Camry 1991 - On

UNIT PACKAGE: 5





## 20575

(Toyota: 67771-12080;  
GM: 88970656)  
Yellow & White Nylon

Door Panel & Rocker Moulding Retainer  
Top Head Diameter: 13mm  
Middle Head Diameter: 16mm  
Bottom Head Diameter: 18mm  
Stem Diameter: 10mm  
Stem Length: 13mm  
Overall Length: 20mm  
Toyota & Lexus 1998 - On  
Pontiac Vibe 2003 - On

UNIT PACKAGE: 15



## 20633

(90467-10188)  
Turquoise Nylon

Trim Panel Retainer  
Top Head Diameter: 13mm  
Middle Head Diameter: 16mm  
Bottom Head Diameter: 18mm  
Stem Diameter: 8.5mm x 9mm  
Stem Length: 14mm  
Overall Length: 20mm  
Sienna 2004 - On

UNIT PACKAGE: 25



## 18876

(Toyota: 90467-10161;  
GM: 94858299)  
White Nylon

Trim Board Retainer  
Top Head Diameter: 13mm  
Middle Head Diameter: 16mm  
Bottom Head Diameter: 18mm  
Stem Diameter: 9mm x 9mm  
Stem Length: 14mm  
Overall Length: 20mm  
Toyota Sienna, Solara & Tercel 1990 - On  
Geo Prizm & Pontiac Vibe 1998 - On

UNIT PACKAGE: 25



## 21822

(Peugeot & Citroen: 6822.LL)  
White Nylon

Door Panel Retainer  
Top Head Diameter: 13mm  
Middle Head Diameter: 16mm  
Bottom Head Diameter: 18mm  
Stem Diameter: 8.5mm x 9mm  
Stem Length: 14mm  
Overall Length: 20mm  
Peugeot, Citroen & Toyota

UNIT PACKAGE: 25

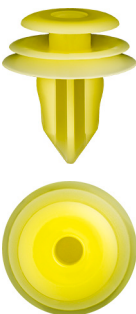

## 19910

(90467-08179)  
Yellow Nylon

Garnish Retainer  
Top Head Diameter: 13mm  
Middle Head Diameter: 16mm  
Bottom Head Diameter: 18mm  
Stem Diameter: 9mm x 9mm  
Stem Length: 14mm  
Overall Length: 20mm  
Tundra 1999 - On

UNIT PACKAGE: 25



## 21102

(90467-A0005)  
White Nylon

Door Trim Panel Retainer with Sealer  
Top Head Diameter: 13mm  
Middle Head Diameter: 16mm  
Bottom Head Diameter: 18mm  
Stem Diameter: 8.5mm  
Stem Length: 14mm  
Overall Length: 20mm  
Lexus ES 350, GX470, IS250, IS 350, IS F, LS 460 &  
LS 600HL and Toyota Camry, FJ Cruiser, Highlander,  
RAV4 & 4-Runner 2001 - On

UNIT PACKAGE: 15



## 20437

(90467-09206)  
White Nylon

Trim Panel Retainer  
Top Head Diameter: 13mm  
Middle Head Diameter: 16mm  
Bottom Head Diameter: 18mm  
Stem Diameter: 8.5mm x 8.5mm  
Stem Length: 15mm  
Overall Length: 20mm  
RAV4 & Tundra 2000 - On

UNIT PACKAGE: 15



## 19257

(67771-12050)  
Nylon

Front & Rear Door  
Trim Board Retainer  
Top Head Diameter: 13mm  
Bottom Head Diameter: 18mm  
Stem Diameter: 9mm  
Stem Length: 14mm  
Lexus and Toyota Celica, Corolla &  
Previa 1990-On

UNIT PACKAGE: 15





**14144**  
(67771-01010)  
Black Nylon

Trim Panel Retainer  
Top Head Diameter: 13mm  
Middle Head Diameter: 15.5mm  
Bottom Head Diameter: 18mm  
Stem Diameter: 9.5mm  
Stem Length: 14mm  
Overall Length: 20.5mm

UNIT PACKAGE: 25



**19898**  
(67771-02030)  
Yellow Nylon

Trim Panel Retainer  
Top Head Diameter: 13mm  
Middle Head Diameter: 16mm  
Bottom Head Diameter: 18mm  
Stem Diameter: 9.5mm  
Stem Length: 13mm  
Overall Length: 21mm  
Corolla 1990 - On

UNIT PACKAGE: 50



**14269**  
(Toyota: 67771-01010, 67771-12010;  
Isuzu: 8942264920;  
Mazda: 9927-40-825)  
White Nylon

Door Panel Retainer  
Top Head Diameter: 13mm  
Middle Head Diameter: 15.5mm  
Bottom Head Diameter: 18mm  
Stem Diameter: 9.5mm  
Stem Length: 14mm  
Overall Length: 20.5

UNIT PACKAGE: 25



**15707**  
(67771-03030)  
Gray Nylon

Door Trim Retainer  
Top Head Diameter: 13mm  
Middle Head Diameter: 16mm  
Bottom Head: 17.5mm  
Stem Length: 14mm  
Stem Diameter: 10mm  
Overall Length: 21mm  
Camry 1988 - On

UNIT PACKAGE: 50



**14270**  
(67771-22010)  
Blue & Natural Nylon

Door Panel Retainer  
Top Head Diameter: 13mm  
Middle Head Diameter: 15.5mm  
Bottom Head Diameter: 18mm  
Stem Diameter: 9.5mm  
Stem Length: 14mm  
Overall Length: 20.5mm

UNIT PACKAGE: 25



**19108**  
(67771-16080)  
Natural Nylon

Door Trim Panel & Back Panel  
Upper Garnish Retainer  
Top Head Diameter: 13mm  
Middle Head Diameter: 16mm  
Bottom Head Diameter: 18mm  
Stem Diameter: 9.5mm  
Stem Length: 14mm  
Overall Length: 21mm  
Truck 1988-On

UNIT PACKAGE: 10



**15709**  
(67771-02030)  
Natural Nylon

Door Trim Retainer  
Top Head Diameter: 13mm  
Middle Head Diameter: 16mm  
Bottom Head Diameter: 17.5mm  
Stem Diameter: 9.5mm  
Stem Length: 13mm  
Overall Length: 21mm  
Corolla 1990 - On

UNIT PACKAGE: 50



**18874**  
(67771-16120)  
Gray Nylon

Front & Rear Door  
Trim Panel Retainer  
Top Head Diameter: 13mm  
Middle Head Diameter: 16mm  
Bottom Head Diameter: 18mm  
Stem Diameter: 9.5mm  
Stem Length: 15mm  
Overall Length: 21mm  
Terrel 1994 - On

UNIT PACKAGE: 15



## 19016

(67771-12040)  
Dark Gray Nylon

Door Trim Panel Retainer  
Top Head Diameter: 13mm  
Middle Head Diameter: 16mm  
Bottom Head Diameter: 18mm  
Stem Diameter: 9.5mm  
Stem Length: 15mm  
Overall Length: 21mm  
Cressida 1992 - 88

UNIT PACKAGE: 15



## 19210

(67771-04040)  
Natural Nylon

Front Door Trim Panel Retainer  
Top Head Diameter: 13mm  
Middle Head Diameter: 16mm  
Bottom Head Diameter: 18mm  
Stem Diameter: 10mm  
Stem Length: 14mm  
Overall Length: 22mm  
Tacoma 1995 -On

UNIT PACKAGE: 50



## 19129

(Toyota: 67771-30090;  
GM: 95008221)  
Yellow Nylon

Door Trim Panel & Back Panel  
Lower Garnish Retainer  
Top Head Diameter: 13mm  
Middle Head Diameter: 16mm  
Bottom Head Diameter: 18mm  
Stem Diameter: 9.5mm  
Stem Length: 17mm  
Overall Length: 23mm  
Land Cruiser & 2WD Truck 1991 - On

UNIT PACKAGE: 15



## 22125

(Toyota: 90467-05170)  
Black Nylon

Front Bumper Push-Type Retainer  
Head Diameter: 10mm  
Stem Length: 10mm  
Fits into 5mm Hole  
Lexus IS 250, IS 350 & NX 300h and Toyota Corolla,  
Highlander, Matrix & RAV4 2012 - On

UNIT PACKAGE: 25



## 21103

(90467-05090-B1)  
Black Nylon

Front Bumper Fascia Push-Type Retainer  
Head Diameter: 10mm  
Stem Length: 12mm  
Fits into 5mm Hole  
Corolla, Matrix & Scion 2008 - On

UNIT PACKAGE: 10



## 17383

(GM: 94847334, 96057847;  
Toyota: 90467-07066;  
Suzuki: 09409-07313)  
Black Nylon

Radiator Grille & Trim Panel  
Push-Type Retainer  
Head Diameter: 11mm  
Stem Length: 14mm (Excluding the Pin)  
Fits into 7mm Hole  
Toyota, Suzuki and Geo Tracker  
& Prizm 1992 - 89

UNIT PACKAGE: 10



## 21218

(90467-05063-C0)  
Black Nylon

Front Bumper Push-Type Retainer  
Head Diameter: 11mm  
Stem Length: 8mm  
Fits into 5mm Hole  
Corolla 2009 - On

UNIT PACKAGE: 15



## 21249

(90467-07071-22)  
Black Nylon

Bumper Cover Push-Type Retainer  
Head Diameter: 11mm  
Stem Length: 9mm (Excluding the Pin)  
Fits into 7mm Hole  
Yaris 2009 - On

UNIT PACKAGE: 25



## 20196

(90467-06133-CO)  
Black Nylon

Rocker Panel Push-Type Retainer  
Head Diameter: 14mm  
Stem Length: 8mm  
Fits into 6mm Hole  
4-Runner 1998 - On

UNIT PACKAGE: 15



**21849**

(Toyota: 90467-05136)  
Black Nylon

Inner Door Lock Plate, Engine Cover &  
Outside Air Duct Push-Type Retainer  
Head Diameter: 13mm  
Stem Length: 15mm  
Fits into 5.5mm Hole  
Lexus & Toyota 2012 - On

UNIT PACKAGE: 25



**19013**

(90467-07059-22)  
Black Nylon

Rear Door Trim &  
Luggage Compartment Door  
Push-Type Retainer  
Head Diameter: 15mm  
Stem Length: 10mm  
Fits into 7mm Hole  
Camry & Celica 1990-On

UNIT PACKAGE: 15



**21104**

(90467-07190-B2)  
Black Nylon

Interior Trim Push-Type Retainer  
Head Diameter: 14mm  
Stem Length: 14mm  
Fits into 7mm Hole  
Echo & Scion 2004 - On

UNIT PACKAGE: 10



**17206**

(90467-09145)  
Black Nylon

Bumper Cover Push-Type Retainer  
Head Diameter: 15mm  
Stem Length: 12mm (Excluding Pin)  
Fits into 9mm Hole  
Camry 1992-On

UNIT PACKAGE: 15



**17162**

(GM: 96057846;  
Toyota: 90467-07041)  
Black Nylon

Push-Type Retainer  
Head Diameter: 15mm  
Stem Length: 8mm (Excluding the Pin)  
Fits into 6.3mm Hole  
Geo Metro & Tracker and  
Toyota 1989 - On

UNIT PACKAGE: 10



**21011**

(90467-07188)  
Black Nylon

Push-Type Retainer  
Head Diameter: 15mm  
Stem Length: 17mm  
Fits into 7mm Hole  
Camry, Tundra & 4-Runner 2002 - On

UNIT PACKAGE: 15



**21120**

(90467-07192)  
Black Nylon

Cowl Vent Push-Type Retainer  
Head Diameter: 15mm  
Stem Length: 9mm (Excluding the Pin)  
Fits into 7mm Hole  
RAV4 2002 - On

UNIT PACKAGE: 15



**19552**

(90467-07146)  
Black Nylon

Cowl Panel & Luggage  
Compartment Retainer  
Head Diameter: 16mm  
Stem Length: 9mm  
Fits into 7mm Hole  
Avalon, Camry, Celica & Solara 1993 - On

UNIT PACKAGE: 15



**14260**

(Toyota: 90467-06017;  
Mazda: 9926-50-625;  
GM: 20426301)  
Black Nylon

Push-Type Retainer  
Head Diameter: 15mm  
Stem Length: 12mm  
Fits into 7mm Hole

UNIT PACKAGE: 15



**21624**

(90467-10206)  
Black Nylon

Cowl Push-Type Retainer  
Head Diameter: 16mm  
Stem Length: 10mm  
Fits into 8mm Hole  
Toyota Camry, Sequoia, Tundra & Yaris and  
Lexus ES 350, RX350 & RX 450h 2006 - On

UNIT PACKAGE: 15





## 21325

(90080-46294)  
Black Nylon

Turn Signal Light & General Purpose  
Push-Type Retainer  
Head Diameter: 16mm  
Stem Length: 14mm  
Fits into 7mm Hole  
Tundra 2003 - On

UNIT PACKAGE: 10



## 20335

(53879-60010)  
Black Nylon

Fender Liner Push-Type Retainer  
Head Diameter: 18mm  
Stem Length: 7mm  
Fits into 7mm Hole  
Land Cruiser & RAV4 1998 - On

UNIT PACKAGE: 15



## 20869

(GM: 88970767;  
Toyota: 90467-10183)  
Black Nylon

Front Fender Liner  
Push-Type Retainer  
Head Diameter: 18mm  
Stem Length: 7.5mm  
Fits into 7mm Hole  
Celica, Corolla, Matrix & Solara, Lexus  
and Pontiac Vibe 1999 - On

UNIT PACKAGE: 10



## 19490

(90467-06150)  
Black Nylon

Back Garnish Trim Panel  
Push-Type Retainer  
Head Diameter: 18mm  
Stem Length: 8mm  
Fits into 6mm Hole  
Tacoma 1995 - On

UNIT PACKAGE: 10



## 20349

(Toyota: 90467-08185;  
Nissan: 01553-09611)  
Black Nylon

Push-Type Retainer  
Head Diameter: 18mm  
Stem Length: 10mm (Excluding the Pin)  
Fits into 8mm Hole  
Lexus & Toyota 2002 - On  
Nissan 1994 - On

UNIT PACKAGE: 15



## 21547

(90467-09185)  
Black Nylon

Front Spoiler & Grille  
Push-Type Retainer  
Head Diameter: 18mm  
Stem Length: 10mm  
Fits into 9mm Hole  
Toyota Celica, Sequoia, Sienna & 4  
Runner and Lexus HS 250h 1994 - On

UNIT PACKAGE: 25



## 21123

(75867-30120)  
Black Nylon

Rocker Moulding Push-Type Retainer  
Head Diameter: 18mm  
Stem Length: 12mm (Excluding the Pin)  
Fits into 8mm Hole  
Toyota Camry and Lexus GS350,  
GS430, GS460 & LS460 2007 - On

UNIT PACKAGE: 15



## 16784

(Nissan: 80999-05N07;  
Toyota: 90467-07043)  
Black Nylon

Push-Type Retainer  
Head Diameter: 18mm  
Stem Length: 11mm  
(Excluding the Pin)  
Fits into 7mm Hole

UNIT PACKAGE: 25



## 19416

(Toyota: 90467-09139)  
Black Nylon

Bumper Cover & Wheel Housing  
Push-Type Retainer  
Head Diameter: 18mm  
Stem Length: 12mm (Excluding the Pin)  
Fits into 9mm Hole  
Honda, Mazda 626 &  
Toyota Corolla 1992 - On

UNIT PACKAGE: 15



## 21702

(Toyota: 90467-10170-C0)  
Black Nylon

Cowl Vent, Upper Radiator Cover &  
Wheel Apron Push-Type Retainer  
Head Diameter: 18mm  
Stem Length: 12mm  
Fits into 10mm Hole  
Lexus LS 460, LS 600, RX 350  
& RX 450 and Toyota RAV4 2006 - On

UNIT PACKAGE: 10



**21225**  
(53888-48010)  
Black Nylon

Wheel Opening Push-Type Retainer  
Head Diameter: 18mm  
Stem Length: 14mm  
Fits into 7mm Hole  
Highlander 2001 - On

UNIT PACKAGE: 5



**18873**  
(52161-16010, 52161-02020)  
Black Nylon

Rear Bumper Cover  
Push-Type Retainer  
Head Diameter: 18mm  
Stem Length: 28mm  
Fits into 9mm Hole  
Terrel 1988 - On

UNIT PACKAGE: 6



**20931**  
(52161-20010)  
Black Nylon

Bumper Cover & Grille  
Push-Type Retainer  
Head Diameter: 18mm  
Stem Length: 31mm  
Fits into 9mm Hole  
Toyota 2000 - On

UNIT PACKAGE: 15



**22126**  
(Toyota: 53384-68010)  
Black Nylon

Front Grille Push-Type Retainer  
Rubber Head Diameter: 19mm  
Bottom Head Diameter: 18mm  
Stem Length: 28mm  
Fits into 9mm Hole  
Scion tC & Toyota RAV4 2005 - On

UNIT PACKAGE: 15



**19908**  
(90467-07121)  
Black Nylon

Door Trim Panel Push-Type Retainer  
Head Diameter: 20mm  
Stem Length: 8mm (Excluding the Pin)  
Fits into 7mm Hole  
RAV4 1997 - On

UNIT PACKAGE: 10



**19907**  
(90467-07121-B2)  
Nylon

Door Trim Panel  
Push-Type Retainer  
Head Diameter: 20mm  
Stem Length: 8mm (Excluding the Pin)  
Fits into 7mm Hole  
RAV4 1997 - On

UNIT PACKAGE: 10



**20577**  
(GM: 88970494, 88973676)  
Toyota: 90467-07168)  
Black Nylon

Rocker Panel & Garnish Moulding  
Push-Type Retainer  
Head Diameter: 20mm  
Stem Length: 8mm  
Fits into 7mm Hole  
Pontiac Vibe 2003 - On  
Lexus & Toyota 2000 - On

UNIT PACKAGE: 15



**18888**  
(90467-07166)  
Black Nylon

Front Fender Liner  
Push-Type Retainer  
Head Diameter: 20mm  
Stem Length: 8mm (Excluding the Pin)  
Fits into 7mm Hole  
Terrel 1994 - On

UNIT PACKAGE: 15



**19128**  
(90467-07044)  
Black Nylon

Quarter Panel Wheel Opening  
Moulding Push-Type Retainer  
Head Diameter: 20mm  
Stem Length: 9mm  
Fits into 7mm Hole  
T-100 1992 - On

UNIT PACKAGE: 10



**21294**  
(90467-07214)  
Black Nylon

Radiator Splash Shield  
Push-Type Retainer  
Head Diameter: 20mm  
Stem Length: 9mm  
Fits into 7mm Hole  
Camry 2007 - On

UNIT PACKAGE: 25



## 21010

(90467-09166)  
Black Nylon

Push-Type Retainer  
Head Diameter: 20mm  
Stem Length: 9mm  
Fits into 9mm Square Hole  
Camry 2006 - On

UNIT PACKAGE: 15



## 20908

(Toyota: 90467-07164;  
Suzuki: 09409-07332)  
Black Nylon

Fender Splash Shield  
Push-Type Retainer  
Head Diameter: 20mm  
Stem Length: 10mm  
Fits into 7mm Hole  
Camry, Echo, MR2 & Sienna 1997 - On  
Suzuki 1999 - On

UNIT PACKAGE: 10



## 20955

(90467-07201)  
Black Nylon

Engine Under Cover  
Push-Type Retainer  
Head Diameter: 20mm  
Stem Length: 10mm  
Fits into 7mm Hole  
Lexus ES300/330 and Toyota Avalon,  
Camry & Solara 2002 - On

UNIT PACKAGE: 10



## 21856

(Toyota: 51454-48010, 51454-0E010)  
Black Nylon

Front Bumper Extension  
Mounting Bracket Push-Type Retainer  
Head Diameter: 20mm  
Stem Length: 12mm  
Fits into 10mm Hole

Lexus IS CV, F, RX330 & RX400 Hybrid 2006 - On  
Toyota Highlander, Sienna & Venza 2009 - On

UNIT PACKAGE: 15



## 21596

(Toyota: 75867-06030)  
Black Nylon

Rocker Panel Push-Type Retainer  
Head Diameter: 20mm  
Stem Length: 16mm  
Fits into 8mm Hole  
Toyota & Lexus 2007 - On

UNIT PACKAGE: 25



## 19140

(Acura: 90505-SL0-003;  
GM: 94852368;  
Mitsubishi: MB888869;  
Toyota: 90467-08155)  
Black Nylon

Push-Type Retainer  
Head Diameter: 20mm  
Stem Length: 21mm  
Fits into 8mm Hole

Acura, Dodge Avenger, Eagle Talon,  
Geo Prizm, Mitsubishi Eclipse & Galant  
and Toyota 1993-On

UNIT PACKAGE: 5



## 19739

(90467-09127)  
Black Nylon

Bumper Cover Push-Type Retainer  
Head Diameter: 20mm  
Stem Length: 26mm  
Fits into 9mm Hole  
Avalon, Camry,  
Corolla & Solara 1998 - On

UNIT PACKAGE: 10



## 21860

(Toyota: 51453-48010, 51453-0E010)  
Black Nylon

Front Side Lower  
Fender Panel Bracket  
Push-Type Retainer  
Head Diameter: 22mm  
Stem Length: 14mm  
Fits into 13mm Hole  
Lexus RX330 2009-2004  
Toyota Highlander 2010 - On

UNIT PACKAGE: 15



## 21366

(90467-09227)  
Black Nylon

Bumper & Engine Under Cover  
Push-Type Retainer  
Head Diameter: 22mm  
Stem Length: 15mm  
Fits into 9mm Hole  
4 Runner, RAV4 & Scion XB 2006 - On

UNIT PACKAGE: 10



**19219**  
(90467-09096)  
Black Nylon

Front Bumper  
Push-Type Retainer  
Head Diameter: 15mm  
Stem Length: 27mm  
Fits into 9mm Hole  
Lexus LS400 1993-On  
Celica & Supra 1989-On

UNIT PACKAGE: 10



**22072**  
(Toyota: 76923-47010)  
Black Nylon

Rocker Moulding  
Push-Type Retainer  
Head Diameter: 38mm  
Stem Length: 32mm  
Fits into 22mm Hole  
Lexus HS 250h & CT 200h  
and Toyota Prius 2010 - On

UNIT PACKAGE: 5



**14732**  
(53455-14020)  
Nylon

Hood Prop Rod Clip  
Holds 8mm Diameter Rod  
Snaps into 14mm Hole

UNIT PACKAGE: 15



**16780**  
(Nissan: 99604-H1400;  
Toyota: 58788-13010)

Hood Prop Rod Clip  
Holds 11mm Diameter Rod  
Fits into 10mm x 12mm Hole

UNIT PACKAGE: 10



**17631**  
(90959-01136)  
Nylon

Hood Prop Rod Clip  
Holds 6mm & 7mm Rods  
Toyota

UNIT PACKAGE: 25



**17611**  
(53452-90351)  
Nylon

Hood Prop Rod Clip  
Holds 6mm & 7mm Rods  
Toyota

UNIT PACKAGE: 10



**19529**  
(53455-33010, 53455-33011)  
Natural Nylon

Hood Prop Rod Clip  
Holds 9mm Rod  
Fits into 10mm Square Hole  
Camry 1996 - On

UNIT PACKAGE: 15



**21336**  
(69293-30030)  
Natural Nylon

Door Lock Rod Clip  
Rod Size: 5mm  
Overall Height: 20mm  
Fits into 8mm Hole  
Toyota & Lexus 1993 - On

UNIT PACKAGE: 10



**20469**  
(69293-12030)  
Natural Nylon

Door Lock Rod Clip  
Rod Size: 5mm  
Right (Passenger) Side  
Lexus ES 300 2001 - 97  
Toyota Camry, Celica, Corolla, Echo,  
Highlander, MR2, RAV4, Tundra and  
4-Runner 1994 - On

UNIT PACKAGE: 10



**20470**  
(69293-12040)  
Yellow Nylon

Door Lock Rod Clip  
Rod Size: 5mm  
Left (Driver) Side  
Lexus ES 300 2001 - 97  
Toyota Camry, Celica, Corolla, Echo,  
Highlander, MR2, RAV4, Tundra and  
4-Runner 1994 - On

UNIT PACKAGE: 10





### 20534

(69293-12050)  
Natural Nylon

Door Lock Rod Clip  
Rod Size: 5mm  
Fits into 8.5mm Hole  
Right (Passenger) Side  
Lexus ES250, 300 & RX300  
and Toyota Tacoma  
1990 - On

UNIT PACKAGE: 10

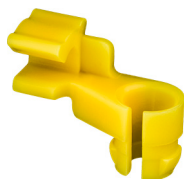

### 20535

(69293-12060)  
Yellow Nylon

Door Lock Rod Clip  
Rod Size: 5mm  
Fits into 8.5mm Hole  
Left (Driver) Side  
Lexus ES250, 300 & RX300  
and Toyota Tacoma 1990 - On

UNIT PACKAGE: 10

### 14284

(Toyota: 90463-10337;  
Honda: 90669-671-000; 90669-671-003)  
Nylon



*Photo not actual size*  
Cable Strap  
Length: 110mm (5-5/16")  
Max. Bundle Diameter: 23mm  
Fits into 6mm Hole

UNIT PACKAGE: 15

### 21553

(82711-12200)  
Black Nylon



*Photo not actual size*  
Length: 170mm (6-3/4")  
Cable Strap  
Width: 7mm (7/32")  
Max. Bundle Diameter: 40mm (1-9/16")  
Camry, Celica, Corolla, Cressida,  
Land Cruiser, MR-2, Paseo, Previa, RAV4, Supra,  
T-100, Tercel & 4-Runner 1998 - On

UNIT PACKAGE: 25

### 20380

(Not Supplied by O.E.M.)  
Black Nylon



*Photo not actual size*  
Cable Strap  
Width: 5mm (3/16")  
Length: 200mm (8")  
Max. Bundle Diameter: 44mm (1-3/4")  
Fits into 6.3mm (1/4") Hole  
Import Cars

UNIT PACKAGE: 25



### 16306

(90183-03001)

Front Bumper Cushion Clip  
Toyota 1982 - On

UNIT PACKAGE: 25



### 16671

(90468-04030)

Bumper Strip Retainer  
Toyota 1984 - On

UNIT PACKAGE: 25



### 21611

(76879-44010)  
Dacromet

Front and Rear Spoiler  
Locking Fastener  
Width: 16mm  
Corolla, Matrix, Prius & Solara 2003 - On

UNIT PACKAGE: 15



### 22097

(Toyota: 90950-01620)  
Black Nylon

Hole Plug  
Head Diameter: 30mm  
Height: 5.6mm  
Fits into 22mm Hole  
Lexus ES, RX & SC; Scion iQ,  
tC, xA, xB & xD and Toyota  
Avalon, Camry, Celica, Corolla,  
FJ Cruiser, Highlander, Matrix,  
Prius, RAV4, Sequoia, Sienna,  
Tacoma, Tundra & Yaris 1984 - On

UNIT PACKAGE: 15



**21337**

(65613-07010)  
Black Nylon

Cowl Vent & Fender Apron  
Nylon Flange Nut  
Flange Diameter: 22mm  
Stud Size: 6mm  
Overall Height: 10mm  
Venza 2009 - On

UNIT PACKAGE: 15



**14750**

(Toyota: 53879-14010-A,  
53879-14020, 53879-22030;  
GM: 94841226;  
Mazda: LA01-56-135)  
Black Nylon

Fender/Wheel Housing  
Screw Size: #10  
Width: 20mm  
Length: 31mm  
Panel Range: Up to 1mm  
Center of Hole to Edge: 11mm  
Toyota, Geo and Mazda

UNIT PACKAGE: 15

**19669**

Same as 14750 except for unit packing quantity

UNIT PACKAGE: 25



**21359**

(53879-17020)  
Black Nylon

Bumper & Fender Apron U-Nut  
Screw Size: M4.8 (#10)  
Panel Range: Up to 2mm  
Center of Hole to Edge: 10mm  
Toyota Celica and Lexus 2000 - On

UNIT PACKAGE: 10



**21616**

(76647-42010)  
Black Nylon

Fender & Mudguard U-Nut  
Screw Size: M4.8 (#10)  
Panel Range: Up to 2mm  
Center of Hole to Edge: 7mm  
RAV4 2001 - On

UNIT PACKAGE: 15



**21613**

(53879-20020)  
Black Nylon

Front Fender Liner Nylon U-Nut  
Screw Size: M5.5 (#12)  
Panel Range: Up to 2mm  
Center of Hole to Edge: 11mm  
Camry & Sienna 1996 - On

UNIT PACKAGE: 15

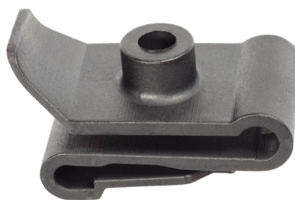

**20956**

(90467-05114)  
Black Nylon

Bumper & Fender  
Apron Nylon U-Nut  
Screw Size: M5.5 (#12)  
Width: 20mm  
Length: 36mm  
Panel Range: Up to 1mm  
Center of Hole to Edge: 14mm  
Lexus & Toyota 2000 - On

UNIT PACKAGE: 10

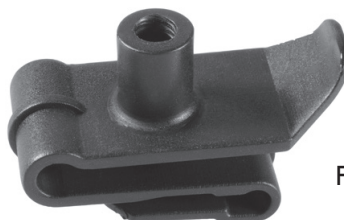

**21687**

(Toyota: 90467-05138)  
Black Nylon

Front Bumper & Fender  
Liner Nylon U-Nut  
Screw Size: M6.3 (#14)  
Panel Range: Up to 3mm  
Center of Hole to Edge: 14mm  
Lexus GX 460, GX 470 & LX 570, Scion tC and Toyota  
Corolla, FJ Cruiser, Land Cruiser, Matrix, Sequoia,  
Tacoma, Tundra & 4 Runner 2003 - On

UNIT PACKAGE: 15

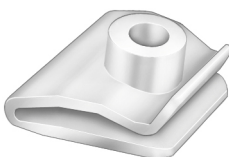

**21614**

(90467-05128)  
White Nylon

Rear Bumper & Bumper Stay  
Nylon U-Nut  
Screw Size: M6 (#14)  
Panel Range: Up to 2mm  
Center of Hole to Edge: 12mm  
RAV4 & Yaris 1996 - On

UNIT PACKAGE: 15



**21615**

(90467-A0018, 90467-05081)  
Maroon Nylon

Left & Right Front Bumper  
& Bumper Stay Nylon U-Nut  
Screw Size: M6 (#14)  
Panel Range: Up to 2mm  
Center of Hole to Edge: 12mm  
Toyota Avalon, Camry & Solara  
and Lexus 2000 - On

UNIT PACKAGE: 15

# TOYOTA, VOLKSWAGEN & AUDI CLIPS AND FASTENERS

(Includes SEAT & Skoda)

Sec. 22



**14276**

(53879-22010)  
Black Nylon

Nylon U-Nut Fender/Wheel  
Housing Applications  
Screw Size: #14(1/4")  
Width: 20mm  
Length: 29mm  
Panel Range: Up to 1mm  
Center of Hole to Edge: 15mm

UNIT PACKAGE: 15



**13225**

Plated

U-Type Nut  
Screw Size: 4.2mm (#8)  
Width: 11mm  
Length: 16.5mm  
Panel Range: .5mm - 2.5mm  
Center of Hole to Edge: 8mm

UNIT PACKAGE: 50

## VOLKSWAGEN & AUDI CLIPS AND FASTENERS

(Includes SEAT & Skoda)



**15666**

(AMC: 36000148,  
36001966, 56001419;  
VW: 176-941-1117A)

1/4"-28 x 2-1/4"  
Headlight Adjusting  
Screw and Nut Assembly  
AMC & VW

UNIT PACKAGE: 10



**10322**

(131-853-585C)  
Nylon

Body Side Moulding Clip  
VW

UNIT PACKAGE: 50



**13189**

(803-853-139A)  
Nylon

Moulding Clip  
Audi

UNIT PACKAGE: 50



**12635**

(801-853-577)  
Nylon

Moulding Clip  
VW

UNIT PACKAGE: 25



**13174**

(803-853-139C)  
Red Nylon

Moulding Clip  
VW

UNIT PACKAGE: 25

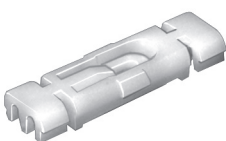

**19136**

(1HO-853-733B)  
Nylon

Windshield Reveal  
Moulding Clip  
VW Golf & Jetta 1999 - 93

UNIT PACKAGE: 15



**21416**

(191-853-733-A)  
White Nylon

Moulding Clip  
Width: 8mm  
Length: 31mm  
Passat 1997 - 90

UNIT PACKAGE: 25



**21760**  
(VW: 6Q0-868-246-A)  
White Nylon

Moulding Clip  
Width: 25mm  
Length: 40mm  
Thickness: 8mm

Audi 2004 - On  
Eos, Golf, GTI, Passat, R32 & Rabbit 2005 - On

UNIT PACKAGE: 25



**21493**  
(4A0-853-825-A)  
White Nylon

Front & Rear Door Moulding Clip  
Width: 22mm  
Length: 35mm  
Audi 1998 - 92

UNIT PACKAGE: 25



**21390**  
(191-853-577-A)  
White Nylon

Door Moulding Clip  
Top Head Size: 11.6mm x 15mm  
Bottom Head Diameter: 11mm  
Stem Diameter: 6mm  
Stem Length: 14mm  
VW & Audi 1985 - On

UNIT PACKAGE: 25



**21508**  
(191-853-577)  
White Nylon

Door Trim & Scuff Plate  
Moulding Clip  
Head Size: 12mm x 15mm  
Stem Diameter: 10mm  
Stem Length: 19mm  
Audi A1 & A2 and VW Golf & Jetta

UNIT PACKAGE: 25



**21449**  
(3B0-853-575)  
White Nylon  
Blue Rubber Grommet

Moulding Clip  
Width: 17.5mm  
Length: 21mm  
Stem Length: 12mm  
Passat 2005 - 1998

UNIT PACKAGE: 25

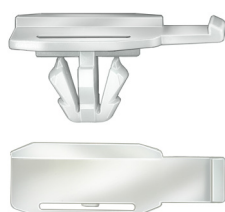

**21512**  
(7L0-839-069)  
White Nylon

Rocker Panel Moulding Clip  
Width: 10mm  
Length: 28.5mm  
Stem Length: 11mm  
Fits into 10mm Hole  
Touareg 2010 - 05

UNIT PACKAGE: 25



**21761**  
(VW: 3C0-853-585,  
3C9-827-407, 3C9-827-408)  
White Nylon

Upper Door Cover Strip Scuff  
Protection Moulding Clip  
Top Head Size: 13mm x 16mm  
Bottom Head Diameter: 14mm  
Stem Length: 13mm  
Fits into 9mm Hole  
Passat, Tiguan & Touareg 2006 - On

UNIT PACKAGE: 25



**21491**  
(443-853-909-A)  
Natural Nylon

Front Door, Fender &  
Quarter Panel Moulding Clip  
Width: 20mm  
Length: 41.5mm  
Audi 1998 - 88

UNIT PACKAGE: 25



**21481**  
(Audi: 4A0-853-825-C)  
White Nylon

Rear Door Moulding Clip  
Width: 26mm  
Length: 34.5mm  
Stem Length: 6mm

Audi 100, A6, S4, S6 & Quattro 1998 - 92

UNIT PACKAGE: 25



**21448**  
(3A0-853-575-A)  
White Nylon  
Blue Rubber Grommet

Moulding Clip  
Width: 16mm  
Length: 17mm  
Stem Length: 13mm  
Passat 1997 - 95

UNIT PACKAGE: 25



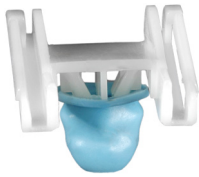

### 21447

(3B0-853-576)  
White Nylon  
Blue Rubber Grommet

Moulding Clip  
Width: 24.5mm  
Length: 27mm  
Stem Length: 12mm  
Passat 2005 - 1998

UNIT PACKAGE: 15

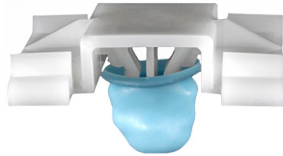

### 21394

(1H0-853-585)  
White Nylon  
Blue Rubber Grommet

Door Moulding Clip  
Width: 34mm  
Length: 38.5mm  
Stem Length: 10mm

Audi & VW Cabrio, Golf & Jetta 2002 - 1993

UNIT PACKAGE: 15



### 21395

(1H0-853-585-B)  
White Nylon  
Blue Rubber Grommet

Door Moulding Clip  
Width: 34mm  
Length: 38.5mm  
Stem Length: 18mm  
Audi & VW Cabrio 2002 - 1999

UNIT PACKAGE: 15



### 21492

(4A0-853-825)  
White Nylon

Front & Rear Door, Fender &  
Quarter Panel Moulding Clip  
Width: 22mm  
Length: 35mm  
Overall Height: 16mm  
Audi 1998 - 92

UNIT PACKAGE: 25



### 21396

(1H0-853-858-A)  
White Nylon  
Blue Rubber Grommet

Quarter Panel Moulding Clip  
Width: 23mm  
Length: 40mm  
Stem Length: 11mm

Audi & VW Cabrio, Golf & Jetta 2002 - 1993

UNIT PACKAGE: 15



### 21478

(3A0-853-575)  
White & Orange Nylon  
Blue Rubber Boot

Door, Fender &  
Quarter Panel Moulding Clip  
Width: 35mm  
Length: 38mm  
Stem Length: 14mm  
Volkswagen 1997 - 90

UNIT PACKAGE: 15



### 22108

(VW: 4A0-867-276A)  
Zinc

Trim Moulding Clip  
Overall Height: 16mm  
Audi & Volkswagen 2012 - 1998

UNIT PACKAGE: 25



### 13173

(VW: N14389.3; Volvo: 3104-426)  
Metal

Door Panel Clip  
Use with Auveco 13206

UNIT PACKAGE: 50



### 21994

(VW: 3A0-867-301-01C)  
Black Nylon

Door Panel Clip  
Width: 20mm  
Length: 28mm  
Stem Diameter: 7.5mm  
Stem Length: 6mm  
VW, Audi, SEAT & Skoda

UNIT PACKAGE: 15



### 21993

(VW: 321-867-299B)  
Natural Nylon

Door Panel Clip  
Width: 20mm  
Length: 18.5mm  
Stem Diameter: 7.5mm  
Stem Length: 6mm  
VW, Audi, SEAT & Skoda

UNIT PACKAGE: 10



### 8843

Nylon

Moulding Fastener  
Fits 1/2" - 5/8" Mouldings

UNIT PACKAGE: 50

**VOLKSWAGEN & AUDI CLIPS AND FASTENERS**  
(Includes SEAT & Skoda)



**21498**  
(191-941-142)  
White Nylon

Headlight Adjusting Nut  
Head Size: 14mm x 18.5mm  
Overall Length: 15mm  
Fits into 10mm Hole  
Audi 100 and VW Golf 1994 - 86

UNIT PACKAGE: 25



**21985**  
(VW: N905-353-01)  
Gray Nylon

Nylon Nut  
Screw Size: M4.2 (#8)  
Head Size: 10mm x 10mm  
Stem Length: 9.5mm  
VW, Audi, SEAT & Skoda

UNIT PACKAGE: 25



**14014**  
(VW: 175-853-674; GM: 20475950)  
Black Nylon

Air Vent Nut

UNIT PACKAGE: 50



**12735**  
(GM: 1370853; Chry: 6029501;  
VW: 179-813-883)  
Nylon

Headlight Bezel Nut  
Screw Size: #6  
GM & VW 1982 - On

UNIT PACKAGE: 50



**14030**  
(GM: 3997391; VW: 179-813-881)  
Black Nylon

Tail Light Nut  
Screw Size: #8  
GM Astro & Safari 1985-On  
Volkswagen

UNIT PACKAGE: 25



**21510**  
(867-809-966, 811-807-557-C)  
Black Nylon

Screw Grommet  
Screw Size: M4.8 (#10)  
Head Diameter: 12mm  
Stem Length: 12.5mm  
VW & Audi

UNIT PACKAGE: 25



**21480**  
(VW: 165-827-592)  
Natural Nylon

Screw Grommet  
Screw Size: M4.2 (#8)  
Head Diameter: 11mm  
Stem Length: 13mm  
VW Cabrio, EuroVan, Golf &  
Jetta 2003 - 1992

UNIT PACKAGE: 25



**21986**  
(VW: 4A0-857-610)  
Black Nylon

Screw Grommet  
Screw Size: M5.5 (#12)  
Head Diameter: 17mm  
Stem Length: 17mm  
VW, Audi, SEAT & Skoda

UNIT PACKAGE: 15



**20924**  
(N908-338-01)  
Black Nylon

Fender Apron Screw Grommet  
Screw Size: M4.2 (#8)  
Head Diameter: 15mm  
Stem Length: 12mm  
Cabrio, Golf, Jetta &  
Phaeton 1999 - On

UNIT PACKAGE: 15



**20925**  
(N908-214-01)  
Black Nylon

Bumper & Fender Apron  
Screw Grommet  
Screw Size: M4.2 (#8)  
Head Diameter: 15mm  
Stem Length: 20mm  
Audi A4/S4 and A6/S6 1996 - On  
VW Cabrio, Golf, Jetta & Phaeton 1999 - On

UNIT PACKAGE: 15



**21399**  
(811-807-577-C)  
Black Nylon

Screw Grommet  
Screw Size: M4.8 (#10)  
Head Diameter: 7mm x 12.5mm  
Stem Length: 11mm  
Audi Quattro, A4, A6, A8, RS6, S4, S6, TT & 90 and  
Volkswagen Golf, Jetta & Passat 2010 - 1990

UNIT PACKAGE: 25



### 21816

(VW: 6N0-809-966A)  
Black Nylon

Screw Grommet  
Screw Size: M4.8 (#10)  
Head Diameter: 12mm  
Stem Length: 15mm  
Fits into 6.5mm x 8mm Hole  
VW, Audi, SEAT & Skoda

UNIT PACKAGE: 25



### 20933

(357-827-998)  
Black Nylon

Front & Rear Door Panel  
Screw Grommet  
Screw Size: M4.8 (#10)  
Head Diameter: 16mm  
Stem Length: 20mm  
Cabrio, Golf, Jetta & Passat 1993 - On

UNIT PACKAGE: 15



### 21890

(VW: 357-868-143)  
Gray Nylon

Screw Grommet  
Screw Size: M5.5 (#12)  
Head Diameter: 16mm  
Stem Length: 23mm  
VW, Audi, SEAT & Skoda

UNIT PACKAGE: 25



### 21987

(VW: N105-168-01; BMW: 51127020321)  
White Nylon

Screw Grommet with Black Rubber Sealer  
Screw Size: M5.5 (#12)  
Head Diameter: 13mm  
Stem Length: 16mm  
VW, Audi, SEAT, Skoda & BMW

UNIT PACKAGE: 15



### 21988

(VW: N-106-213-01; Ford: 1725489)  
White Nylon

Screw Grommet with Black Rubber Sealer  
Screw Size: M4.8 (#10)  
Head Diameter: 16mm  
Stem Length: 16mm  
VW, Audi, SEAT, Skoda & Ford

UNIT PACKAGE: 10



### 21815

(VW: 4A0-805-163, 8A0-863-821Q)  
Black Nylon

Upper & Lower Engine Cover  
Locking Pin Grommet  
Overall Width: 20mm  
Overall Height: 16mm  
VW, Audi, SEAT & Skoda 1998 - On

UNIT PACKAGE: 25



### 22094

(VW: 4L0-886-373)  
White & Black Nylon

Front & Rear Seat Bottom  
and Bench Grommet  
Top Head Size:  
27.6mm x 40mm  
Bottom Head Size:  
25mm x 37mm  
Stem Length: 30mm  
Overall Length: 40mm  
Audi & Volkswagen 2013 - 2007

UNIT PACKAGE: 10



### 13227

(113-853-615A)  
Nylon

Barrel Nut  
For 3mm Stud  
Fits into 4mm Hole

UNIT PACKAGE: 50



### 20250

(357-853-586-D)  
Black Nylon

Moulding Insert  
Head Diameter: 13mm  
Stem Length: 6mm  
Fits into 9mm Hole  
EuroVan, Golf, Jetta &  
Passat 1989 - On

UNIT PACKAGE: 25



### 13206

(113-857-219A)  
Black Vinyl

Door Panel & Trunk Liner Plug  
**Use with Auveco 13173**  
VW Beetle & Audi

UNIT PACKAGE: 50



**21397**  
(1H0-853-586)  
Blue Rubber

Moulding Clip Grommet  
Inner Diameter: 7mm  
Flange Outer Diameter: 13mm  
Overall Length: 12mm  
**Use with Auveco Moulding Clips:  
21394, 21395 & 21396**  
Audi and VW Cabrio, Golf,  
Jetta, Passat & Touareg 2007 - 1990

UNIT PACKAGE: 50



**21981**  
(VW: 1H0-823-717)  
Black Nylon

Weatherstrip Retainer  
Head Size: 5.5mm x 17mm  
Stem Diameter: 5mm  
Stem Length: 7mm  
VW, Audi, SEAT & Skoda

UNIT PACKAGE: 25



**21843**  
(Mercedes-Benz: A901-988-00-25;  
VW: 2D1867741)  
Black Nylon

Rear Entry Scuff Plate Retaining Pin  
Head Size: 15mm x 15mm  
Overall Length: 31mm  
VW LT Van 2007 - 1987  
Mercedes-Benz Sprinter 1995 - On

UNIT PACKAGE: 25



**21982**  
(VW: 251-823-717)  
Black Nylon

Weatherstrip Retainer  
Head Size: 5mm x 13mm  
Stem Diameter: 5mm  
Stem Length: 9mm  
VW, Audi, SEAT & Skoda

UNIT PACKAGE: 25



**22216**  
(VW: 6N0-867-276)  
White Nylon

Windshield Pillar Trim Clip  
Top Head Size: 10mm x 15mm  
Bottom Head Size: 17mm x 25mm  
Overall Height: 20mm  
Volkswagen Beetle, Golf, GTI &  
Jetta 2010 - 2003

UNIT PACKAGE: 15



**21980**  
(VW: 1Z0-837-732A)  
Yellow Nylon

Weatherstrip Retainer  
Head Size: 5mm x 13mm  
Stem Diameter: 5.7mm  
Stem Length: 5mm  
VW, Audi, SEAT & Skoda

UNIT PACKAGE: 25



**22235**  
(Audi: 4F0-825-429A)  
Black Nylon

Splash Shield Retaining Clip  
Size: 22mm x 23mm  
Audi A4, A6, A7, S4, S5, S6,  
S7, Q5 & RS5 2008 - On

UNIT PACKAGE: 25



**21497**  
(1H0-837-719)  
Black Nylon

Weatherstrip Retainer  
with Clear Grommet  
Head Size: 6mm x 15mm  
Stem Diameter: 7.5mm  
Stem Length: 17mm  
Audi A3 and VW Golf, Sharan,  
Transporter & Corsa

UNIT PACKAGE: 25



**22308**  
(Audi: 8K0-821-213A)  
Natural Nylon

Bumper & Side Air Baffle Retaining Clip  
Head Size: 15.3mm x 18.3mm  
Overall Height: 20mm  
Audi A4, A5, A6, Q3, Q5, RS7,  
S4, S5, S6, S7 & SQ5 2015 - On

UNIT PACKAGE: 15



(Includes SEAT & Skoda)



### 21758

(VW: 801-867-299-01C)  
Black Nylon

Door Side Panel, Luggage Compartment  
and Armrest Tray Trim Retaining Clip

Head Diameter: 14mm  
Stem Diameter: 7mm x 9mm  
Stem Length: 18mm

Golf, GTI, Jetta & Rabbit 2005 - 1999

UNIT PACKAGE: 25



### 21984

(VW: 6Y0-823-717)  
Black Nylon

Trim Panel Retainer  
Head Diameter: 10mm  
Stem Diameter: 6mm

Stem Length: 9mm  
VW, Audi, SEAT & Skoda

UNIT PACKAGE: 15



### 21789

(VW: 1H0-867-199-01C)  
Black Nylon

Radiator Grille, Scuff Plate,  
Sill & Trim Panel Retainer

Head Diameter: 23mm  
Stem Diameter: 11mm  
Stem Length: 16mm

Volkswagen & Audi 1997 - On

UNIT PACKAGE: 25



### 21392

(1H0-819-055-B01C)  
Black Nylon

Instrument Panel, Cowl Vent,  
Defroster Grille & Ducts Retainer

Head Diameter: 23mm  
Stem Diameter: 6.5mm  
Stem Length: 16mm

Phillips Drive

Audi and Volkswagen Cabrio, Golf & Jetta 2002 - 1993

UNIT PACKAGE: 25



### 22338

(VW: 3C0-863-559)  
Black Nylon

Wheel House Cover Mount &  
Interior Trim Retainer

Head Diameter: 26mm  
Stem Diameter: 7.6mm  
Stem Length: 28mm  
Volkswagen Passat &  
CC 2012 - 2006

UNIT PACKAGE: 25



### 21842

(VW: N90565301, N90642001)  
Black Nylon

Engine Compartment Cover  
Locking Duo Drive Pin Retainer

Head Diameter: 15.7mm  
Shoulder Diameter: 8.8mm  
Shoulder Length: 6.5mm  
Overall Length: 27mm  
Audi A4, A6 & A8, SEAT,  
Skoda and VW Passat

UNIT PACKAGE: 25



### 21885

(VW: 4A0-805-121C)  
Black Nylon

Cowl Retaining Pin with Slotted Head

Head Diameter: 25mm  
Stem Length: 23mm

VW, Audi, SEAT & Skoda

UNIT PACKAGE: 25



### 21515

(4A0-805-121-A)  
Black Nylon

Front Fender, Bumper &  
Engine Cover Retainer

Slotted Drive  
Head Diameter: 25mm  
Stem Length: 22mm

Passat & Audi 1992 - On

UNIT PACKAGE: 25



### 22208

(VW: 4A0-805-121C)  
Black Nylon

Splash Shield Slotted Retainer

Head Diameter: 25mm  
Stem Length: 24mm

**Use with Auveco 21815**

Audi A4, A6, A8, RS 4, S4, S6 & S8  
and Volkswagen 2011 - 02

UNIT PACKAGE: 15



### 21509

(357-853-575)  
White Nylon

Retainer with Gray Grommet

Top Head Diameter: 12mm  
Bottom Head Diameter: 18mm  
Stem Diameter: 10mm

Stem Length: 16mm  
Golf, Jetta, Passat & Scirocco

UNIT PACKAGE: 25



**21496**

(357-853-585-A)  
White Nylon

Trim Panel Retainer with  
Black Nylon Grommet  
Top Head Diameter: 12mm  
Bottom Head Diameter: 18mm  
Stem Diameter: 10mm  
Stem Length: 12mm  
Golf & Passat and Audi B3

UNIT PACKAGE: 15



**21495**

(7L5-853-994)  
Blue Nylon

Trim Panel Retainer  
Top Head Diameter: 13mm  
Bottom Head Diameter: 18mm  
Stem Diameter: 9mm  
Stem Length: 14mm  
VW, Audi & Renault

UNIT PACKAGE: 25



**21783**

(VW: 6Q0-868-297)  
Black Nylon

Trim Panel Retainer  
Top Head Diameter: 16mm  
Bottom Head Diameter: 16mm  
Stem Diameter: 10mm  
Stem Length: 9mm  
Golf, GTI, R32 & Rabbit 2006 - On

UNIT PACKAGE: 15



**21893**

(VW: 5J0-867-276)  
White Nylon

Trim Panel Retainer with Sealer  
Top Head Diameter: 13mm  
Bottom Head Diameter: 17mm  
Stem Diameter: 12mm  
Stem Length: 13mm  
VW, Audi, SEAT & Skoda

UNIT PACKAGE: 15



**21853**

(VW: 7M0-867-299-K, 7M3-867-299;  
Land Rover: DYC500020;  
Ford: 1008068)  
Yellow Nylon

Door Trim Panel Retainer with Sealer  
Top Head Diameter: 13mm  
Bottom Head Diameter: 17.5mm  
Stem Diameter: 10.5mm  
Stem Length: 15mm  
Land Rover 1997 - On  
VW & Audi 1999 - On

UNIT PACKAGE: 25



**21516**

(357-853-585)  
White Nylon

Retainer with Black Nylon Grommet  
Top Head Diameter: 12mm  
Bottom Head Diameter: 18mm  
Stem Diameter: 10mm  
Stem Length: 20mm  
VW Golf A2 & A3 and Audi

UNIT PACKAGE: 25



**21819**

Yellow Nylon

Retainer  
Top Head Diameter: 13mm  
Bottom Head Diameter: 17.5mm  
Stem Diameter: 10mm  
Stem Length: 16mm  
VW, Audi, SEAT, Skoda & Ford

UNIT PACKAGE: 25



**13475**

(Renault: 8934-201-681;  
VW: 175-867-299)  
White Nylon

Trim Panel Retainer  
Head Diameter: 19mm  
Stem Length: 18mm  
Stem Diameter: 9mm  
AMC-Renault 1984-On  
VW 1982-On

UNIT PACKAGE: 50



**21450**

(703-867-299)  
Black Nylon

Side Panel & Interior Trim Retainer  
Top Head Diameter: 13.5mm  
Bottom Head Diameter: 18mm  
Stem Diameter: 9mm  
Stem Length: 14mm  
VW 2003 - 1993

UNIT PACKAGE: 25



**21991**

(VW: 6L6-853-575A)  
Black Nylon

Retaining Clip  
Top Head Diameter: 14mm  
Bottom Head Diameter: 14mm  
Stem Diameter: 10mm  
Stem Length: 10mm  
VW, Audi, SEAT & Skoda

UNIT PACKAGE: 10

(Includes SEAT & Skoda)



**13179**

(481-867-197)  
Black Nylon

Trim Panel Retainer  
VW

UNIT PACKAGE: 50



**21494**

(171-807-249-A)  
Natural Nylon

Trim Panel Retainer  
Top Head Diameter: 12mm  
Bottom Head Diameter: 18mm  
Stem Diameter: 9.5mm  
Stem Length: 12mm  
VW Golf & Audi 1978 - On

UNIT PACKAGE: 25



**20252**

(823-867-299)  
Black Nylon

Trim Panel Retainer  
Top Head Diameter: 14mm  
Bottom Head Diameter: 18mm  
Stem Diameter: 9mm  
Stem Length: 14mm  
Corrado, EuroVan, Jetta,  
Rabbit & Vanagon 1979 - On

UNIT PACKAGE: 25



**21992**

(VW: 6E0-837-732)  
White Nylon

Trim Panel Retaining Clip  
Top Head Size: 6.5mm x 11mm  
Bottom Head Diameter: 13.5mm  
Stem Diameter: 5.8mm  
Stem Length: 8mm  
VW, Audi, SEAT & Skoda

UNIT PACKAGE: 15



**21996**

(VW: 8P0-868-243)  
Yellow & White Nylon

Trim Panel Retainer with Sealer  
Top Head Diameter: 19mm  
Bottom Head Diameter: 17mm  
Stem Diameter: 12mm  
Stem Length: 10mm  
VW, Audi, SEAT & Skoda

UNIT PACKAGE: 10



**21995**

(VW: 8Z0-867-646)  
White Nylon

Trim Panel Retainer with Sealer  
Top Head Diameter: 19mm  
Bottom Head Diameter: 17mm  
Stem Diameter: 12mm  
Stem Length: 10mm  
VW, Audi, SEAT & Skoda

UNIT PACKAGE: 10



**22231**

(VW: 1K6-837-200B)  
Black Nylon

Door Panel Retainer  
Top Head Diameter: 10mm  
Middle Head Diameter: 12mm  
Bottom Head Diameter: 12mm  
Stem Diameter: 8mm  
Stem Length: 9mm  
VW Golf V, GTI, Jetta & R32 2010 - 1999

UNIT PACKAGE: 25



**20341**

(3B0-868-243)  
Black Nylon

Door Trim Panel Retainer  
Head Diameter: 22mm  
Stem Length: 10mm  
Fits into 10mm Hole  
Beetle, Golf, Jetta & Passat 1998 - On

UNIT PACKAGE: 25



**21398**

(6K0-868-243-C)  
Black Nylon

Trim Panel Retainer  
Top Head Diameter: 22mm  
Bottom Head Diameter: 18mm  
Stem Length: 12mm  
Fits into 8mm Hole  
Audi and Volkswagen Touareg 2010 - 2004

UNIT PACKAGE: 25



**21144**

(8E0-868-243)  
Black Nylon

Interior Trim Panel  
Retainer with Sealer  
Top Head Diameter: 21.5mm  
Bottom Head Diameter: 27mm  
Stem Diameter: 11mm  
Stem Length: 19mm  
Audi A4 & S4, Avant, Cabriolet,  
Quattro & Sedan Wagon, 2005 - On

UNIT PACKAGE: 25



**21894**

(VW: 5X0-867-299)  
Black Nylon

Trim Panel Retainer  
Top Head Diameter: 22mm  
Bottom Head Diameter: 22mm  
Stem Diameter: 9.3mm  
Stem Length: 14mm  
VW, Audi, SEAT & Skoda

UNIT PACKAGE: 15



**22204**

(Audi: 4D0-867-299D)  
Black Nylon

Door Trim Panel Retainer  
Top Head Size: 14mm x 14mm  
Bottom Head Diameter: 12mm  
Stem Length: 9mm  
Fits into 9mm Hole  
Audi A8, A8 Quattro & S8 2003 - 1997

UNIT PACKAGE: 15



**21708**

(VW: 7L6-868-243)  
Black Nylon

Door Trim Panel Retainer with Sealer  
Head Diameter: 22.5mm  
Stem Diameter: 9mm  
Stem Length: 12mm  
Audi A5, A6, A7, S5, S6 & S7 and  
VW Beetle, Cabrio, Golf, Gti, Jetta, Passat & Touareg 2004 - On

UNIT PACKAGE: 15



**21891**

(VW: N905-333-01)  
Black Nylon

Hood Insulation Retainer  
Head Diameter: 20mm  
Stem Diameter: 11mm  
Stem Length: 7mm  
VW, Audi, SEAT & Skoda

UNIT PACKAGE: 15



**21393**

(1H0-868-243)  
Blue & Black Nylon

Trim Retainer  
Top Head Diameter: 28mm  
Bottom Head Diameter: 19mm  
Overall Length: 31mm  
Audi and Volkswagen Cabrio, Golf & Jetta 1999 - 1993

UNIT PACKAGE: 25



**21145**

(1H5-863-849-A-01C)  
Black Nylon

Hood Insulation Retainer  
Head Size: 20mm x 25mm  
Stem Length: 13mm  
Fits into 12mm Hole  
Audi A4, A6, Cabriolet, Quattro, S4 & S6 and Volkswagen Beetle, Golf, Jetta, Passat, Rabbit & Touareg 1998 - On

UNIT PACKAGE: 15

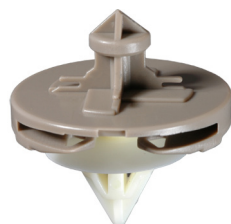

**21415**

(1H0-868-243-B)  
Tan and White Nylon

Adjustable Door Trim Panel Retainer  
Head Diameter: 28.5mm  
Stem Diameter: 9.5mm  
Stem Length: 11mm  
Overall Length: 31mm  
Golf 2002 - 1993

UNIT PACKAGE: 25



**21892**

(VW: 867-863-849-A01C)  
Black Nylon

Hood Insulation Retainer  
Head Size: 23mm x 29mm  
Stem Length: 12mm  
VW, Audi, SEAT & Skoda

UNIT PACKAGE: 25



**21997**

(VW: 6N0-868-243A)  
Black & White Nylon

Trim Panel Retainer  
Top Head Diameter: 28mm  
Bottom Head Diameter: 19mm  
Stem Diameter: 10mm  
Stem Length: 12mm  
VW, Audi, SEAT & Skoda

UNIT PACKAGE: 10



**20187**

(Mercedes: 000-990-34-92;  
BMW: 51-16-1-881-149;  
VW: N-102-593-01)  
Black Nylon

Radiator Housing Push-Type Retainer  
Head Diameter: 10mm  
Stem Length: 10mm  
Fits into 6mm Hole  
Body Styles 116, 123, 124, 126, 129, 140, 170, 201, 208 & 210 1974 - On  
BMW & VW

UNIT PACKAGE: 15



(Includes SEAT & Skoda)



**22238**

(VW: N-905-369-01)  
Black Nylon

Bumper, Hood, Interior Trim &  
Quarter Panel Push-Type Retainer  
Head Diameter: 10mm  
Stem Length: 11mm  
Fits into 5mm Hole  
Audi 90, A4 & S4 and VW Beetle,  
Golf & Jetta 1993 - On

UNIT PACKAGE: 25



**21451**

(333-867-633-4FB)  
Black Nylon

Front Lights & Windshield Washer  
Push-Type Retainer  
Head Diameter: 14mm  
Stem Length: 10mm  
Fits into 8.5mm Hole  
VW 1998 - 95

UNIT PACKAGE: 25



**21989**

(VW: 191-867-775A)  
Black Nylon

Tailgate Push-Type Retainer  
Top Head Diameter: 11mm  
Bottom Head Diameter: 12mm  
Stem Length: 7mm  
Fits into 7mm Hole  
Overall Length: 27mm  
VW, Audi, SEAT & Skoda

UNIT PACKAGE: 10



**22280**

(VW: 3C0-853-934)  
Black Nylon

Splash Shield & Rocker  
Moulding Push-Type Retainer  
Head Diameter: 15mm  
Hex: 8mm (with 4mm Allen Drive)  
Stem Length: 10mm  
Fits into 8mm Hole  
Volkswagen CC 2009 - On  
Passat 2010 - 2006

UNIT PACKAGE: 25



**21391**

(N038-550-1)  
Dark Gray Nylon

Bumper, Exterior Trim, Fender,  
Quarter Panel & Wheel Opening  
Push-Type Retainer  
Head Diameter: 12mm  
Stem Length: 11mm  
Fits into 8mm Hole  
Audi and Volkswagen EuroVan, Golf,  
Jetta & Passat 2003 - 1985

UNIT PACKAGE: 25



**21479**

(701-867-299)  
Gray Nylon

Front Bumper & Interior Trim  
Push-Type Retainer  
Allen Head Drive: 3mm  
Head Diameter: 18.5mm  
Stem Length: 11mm  
Fits into 9mm Hole  
VW Jetta & Passat 1999 - On

UNIT PACKAGE: 25



**21990**

(VW: 6L0-121-136A)  
Black Nylon

Push-Type Retainer  
Head Diameter: 15mm  
Stem Length: 8mm  
Fits into 7mm Hole  
VW, Audi, SEAT & Skoda

UNIT PACKAGE: 15



**22101**

(Audi: 4D0-807-300)  
Black Nylon

Bumper, Fender & Hood  
Insulation Push-Type Retainer  
Head Diameter: 22mm  
Stem Length: 12mm  
Fits into 7.5mm Hole  
Audi A4, A5, A8, Q3, Q5 & S8 1997 - On

UNIT PACKAGE: 15



**19195**

(161-867-299-01C)  
Black Nylon

Push-Type Retainer  
Head Diameter: 16mm  
Stem Length: 12mm  
Fits into 8mm Hole  
VW Golf & Jetta 1997 - 93

UNIT PACKAGE: 25



**22095**

(Audi: N90-229-301)  
Black Nylon

Hood Insulation Push-Type Retainer  
Head Diameter: 22mm  
Stem Length: 13mm  
Fits into 8mm Hole  
Audi & Volkswagen 1986 - On

UNIT PACKAGE: 25



**21251**

(6Q0-868-243)  
Black & White Nylon

Trim Panel Push-Type Retainer with Sealer  
Head Diameter: 22.5mm  
Stem Length: 7mm (Excluding the Pin)  
Fits into 8mm Hole  
Golf, Jetta, Passat, Phaeton, Rabbit & Tiguan 2004 - On

UNIT PACKAGE: 15



**21452**

(1H0-819-055-C01C)  
Black Nylon

Push-Type Retainer  
Top Head Diameter: 23mm  
Bottom Head Diameter: 16mm  
Stem Length: 15mm  
Fits into 8mm x 8mm Square Hole  
VW 2002 - 1993

UNIT PACKAGE: 25



**21482**

(1H0-867-199-A)  
Black Nylon

Push-Type Retainer  
Head Diameter: 24mm  
Stem Length: 13mm  
Fits into 9mm Square Hole  
Passat 1999 - 90

UNIT PACKAGE: 25



**21887**

(VW: 8K0-805-121)  
Black Steel

Phillips Drive Cowl Fastener  
Head Diameter: 16mm  
Stem Diameter: 5mm  
Stem Length: 19mm  
VW, Audi, SEAT & Skoda

UNIT PACKAGE: 10



**21889**

(VW: 8D0-805-121)  
Zinc

Slotted Drive Cowl Fastener  
Head Diameter: 18mm  
Stem Diameter: 7mm  
Stem Length: 18mm  
VW, Audi, SEAT & Skoda

UNIT PACKAGE: 10



**21888**

(VW: 8D0-805-121B)  
Black Steel

Slotted Drive Cowl Fastener  
Head Diameter: 18mm  
Stem Diameter: 7mm  
Stem Length: 20mm  
VW, Audi, SEAT & Skoda

UNIT PACKAGE: 10



**21886**

(VW: 8E0-805-121A)  
Black Steel

Slotted Drive Cowl Fastener with Gasket  
Head Diameter: 18.5mm  
Stem Diameter: 7mm  
Stem Length: 12mm  
VW, Audi, SEAT & Skoda

UNIT PACKAGE: 15



**21483**

(1H0-823-397)  
Natural Nylon

Hood Prop Rod Clip  
Rod Size: 8mm  
Stem Length: 10mm  
Fits into 7mm Square Hole  
VW 1999 - 93

UNIT PACKAGE: 25



**21514**

(6N0-823-397-AC)  
Black Nylon

Hood Prop Rod Clip  
Rod Size: 8mm  
Head Diameter: 15mm  
Fits into 7mm Square Hole  
VW & Audi

UNIT PACKAGE: 25

### 21305

(Not Available from O.E.M.)  
Natural Nylon

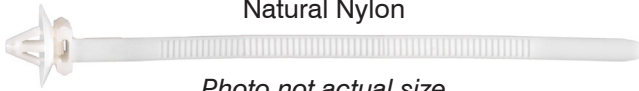

*Photo not actual size*  
Push-Mount Cable Strap  
Overall Length: 156mm (6-1/8")  
Strap Width: 5mm (3/16")  
Snaps into 6.3mm (1/4") Hole  
Maximum Bundle Diameter: 40mm (1-9/16")  
European Makes & Universal

UNIT PACKAGE: 25

### 21513

(N90-335-006)  
Dacromet



Splash Shield & Wheel Well  
Push-On Retainer  
Stud Size: 5mm  
Outer Diameter: 30mm  
VW & Audi

UNIT PACKAGE: 25

### 21485

(N90-796-501, N90-796-502)  
Dacromet

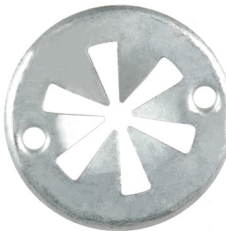

Radiator Support & Splash Shield  
Push-On Retainer  
Stud Size: 5mm  
Outer Diameter: 30mm  
VW 2006 - 1999

UNIT PACKAGE: 25

### 22098

(VW: 4F0-805-163)  
Zinc



Sub Frame Clip  
Width: 13mm  
Length: 27mm  
Audi A6 & S6 and  
Volkswagen 2005 - On

UNIT PACKAGE: 10

### 22116

(VW: 1J6-867-276)  
Zinc Finish



Door Trim Clip  
Overall Height: 22.5mm  
Width at Bottom Base: 13.5mm  
Audi & VW 2004 - On

UNIT PACKAGE: 25



### 21818

(VW: 4A0-867-276)  
Black Spring Steel

Moulding Fastener  
Overall Height: 22mm  
VW, Audi, SEAT & Skoda

UNIT PACKAGE: 25



### 13216

Zinc

U-Nut  
Screw Size: 4.8mm  
Panel Range: .9mm -2mm  
Center of Hole to Edge: 8mm

UNIT PACKAGE: 25

### 22260

(Audi: 8K0-805-922A)  
Zinc

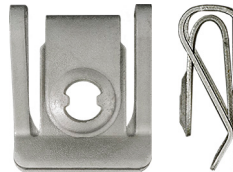

Lower Skid Plate Cover &  
Radiator Support U-Type Nut  
Panel Range: 2.2mm - 5.5mm  
Center of Hole to Edge: 13mm  
Width: 19.3mm  
Length: 23.5mm  
Audi A4, A5, A6, A7, A8, Q5, S4,  
S5, S6 & S8 2012 - 2008

UNIT PACKAGE: 15

### 22113

(BMW: 51127070202;  
VW: N90168602)  
Zinc Finish

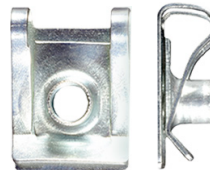

Metric Extruded U-Nut  
Screw Size: M5-.8  
Panel Range: .45mm - 1.5mm  
Center of Hole to Edge: 11.5mm  
BMW 1999 - 1992  
VW 1993 - On

UNIT PACKAGE: 25

### 22291

(VW: N-910-189-01)  
Black Nylon



Front Bumper Support Retainer Nut  
Thread Size: M6.3-1.81  
Hex Size: 10mm  
Flange Diameter: 16.3mm  
Overall Height: 11.3mm  
Beetle, CC, Eos, GTI, Golf,  
Jetta & Rabbit 2003 - On

UNIT PACKAGE: 25

**VOLKSWAGEN & AUDI CLIPS AND FASTENERS**  
(Includes SEAT & Skoda)



**21456**  
(171-201-969)  
Black Nylon

Moulding Nylon Flange Nut  
Stud Size: 5mm  
Hex: 10mm  
Flange Diameter: 18.5mm  
Overall Height: 10.5mm  
Audi A8, S8 & 90 2003 - 1993

UNIT PACKAGE: 25



**12595**  
(GM: 11503752, 11505329;  
VW: N90100001)  
Phosphate

Free Spinning Washer Nut  
Screw Size: M6-1.0  
Washer Outer Diameter: 16mm  
Hex: 10mm

UNIT PACKAGE: 25

**16268**

Same as 12595 except for unit package quantity

UNIT PACKAGE: 50



**21817**  
(VW: N908-131-01)  
Natural Nylon

Nylon Rivet  
Diameter: 6mm  
Grip: 2.0mm - 8.5mm  
Flange Diameter: 13mm  
VW, Audi, SEAT & Skoda

UNIT PACKAGE: 25



**11404**  
(N14-4003)  
Plain Steel

Manifold Stud  
M8-1.25 x 35mm

UNIT PACKAGE: 25

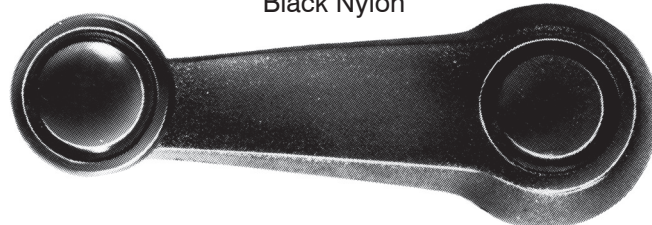

**13031**  
(111-837-581J)  
Black Nylon

*Photo not actual size*

Window Crank Handle  
VW Beetle

UNIT PACKAGE: 1



**14194**  
(321-837-581-016)

*Photo not actual size*

Window Crank Handle  
VW, Scirocco & Dasher 1974 - On

UNIT PACKAGE: 1



**Auveco releases new items every other week.  
Our Hot New Items bulletins can keep you up  
to date on all new product.**

**To receive these bulletins please  
contact customer service:  
mail@auveco.com or 1-800-354-9816**

**We also have all previous and current bulletins  
posted on www.auveco.com.**





**12637**  
(591-740)  
Nylon

Body Side  
Moulding Clip

UNIT PACKAGE: 50



**21784**  
(Volvo: 30784514)  
White Nylon

Moulding Clip  
Top Head Size: 15mm x 17mm  
Bottom Head Size: 9mm x 16mm  
Stem Length: 11mm  
Fits into 8mm Hole  
S80, V70, XC70 & XC90 2007 - On

UNIT PACKAGE: 25



**20405**  
(9151649-2)  
White Nylon

Rocker Panel Moulding Clip  
Stem Length: 14mm  
Fits into 8mm Hole  
850, C70, S70 & V70 1993 - On

UNIT PACKAGE: 10



**22138**  
(Volvo: 30753487)  
Metal &  
White Nylon

Pillar & Exterior Trim Glass Weatherstrip Clip  
Overall Length: 49mm  
Volvo XC60 2008 - On

UNIT PACKAGE: 10



**22137**  
(Volvo: 30753556)  
Metal & White Nylon

Pillar & Exterior Trim Glass Weatherstrip Clip  
Overall Length: 60mm  
Volvo V70 & XC70 2008 - On

UNIT PACKAGE: 10

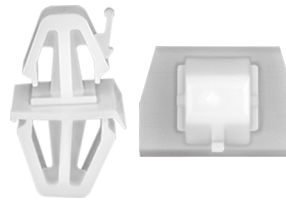

**22340**  
(Volvo: 30808521)  
White Nylon

Rocker Panel Moulding Clip  
Overall Height: 24mm  
Volvo S40 2004 - 2000

UNIT PACKAGE: 15



**13173**  
(VW: N14389.3;  
Volvo: 3104-426)

Metal  
Panel Clip

UNIT PACKAGE: 50

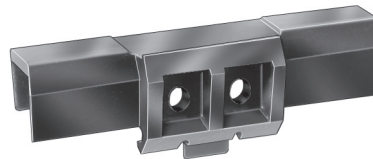

**14211**  
(1-255-551)  
Black Nylon

Windshield Clip

UNIT PACKAGE: 25

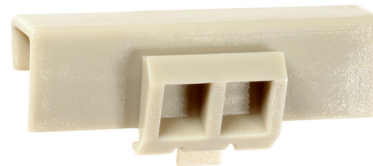

**14212**  
(1-246-926)  
Gray Nylon

Windshield Clip

UNIT PACKAGE: 25

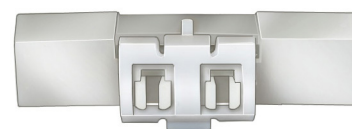

**14210**  
(1-255-553)  
White Nylon

Windshield Clip

UNIT PACKAGE: 15

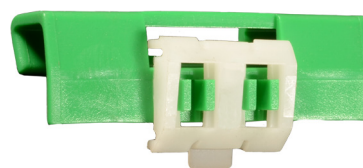

**14209**  
(1-246-993)  
Green Nylon

Windshield Clip

UNIT PACKAGE: 15



**13191**  
(680-097)  
Black Nylon

Moulding Retainer

UNIT PACKAGE: 50

**VOLVO AND UNIVERSAL EUROPEAN  
IMPORT CLIPS & FASTENERS**



**21786**

(Volvo: 30653441)  
Black & White Nylon

Door Trim, Luggage Compartment  
& Armrest Tray Trim Retainer  
Top Head Diameter: 13mm  
Middle Head Diameter: 13mm  
Bottom Head Diameter: 17mm  
Stem Diameter: 8mm  
Stem Length: 9mm  
Overall Length: 15.5mm  
C30, S40, V50, V60 & XC60 2004 - On

UNIT PACKAGE: 25



**21785**

(Volvo: 30624192)  
Black & Yellow Nylon

Rocker Panel Moulding Retainer  
Top Head Diameter: 16mm  
Middle Head Diameter: 17.5mm  
Bottom Head Diameter: 17mm  
Stem Length: 9mm  
Fits into 8mm Hole  
Overall Length: 15mm  
S60 & V60 2011 - On

UNIT PACKAGE: 25



**13230**

(Mercedes 000-990-03-92; Volvo 947-098)  
Black Nylon

Push-Type Retainer  
Head Diameter: 10mm  
Stem Length: 7mm  
Fits into 5mm Hole

UNIT PACKAGE: 50



**21859**

(Mercedes-Benz: 000-990-29-92,  
000-990-60-92, 001-990-16-92,  
114-990-01-92; Opel: 1104882, 1719245;  
Volvo: 9133417, 1268642)  
Black Nylon

Push-Type Retainer  
Head Diameter: 16mm  
Stem Length: 11mm  
Fits into 8mm Hole  
Mercedes-Benz, Opel & Volvo 1985 - On

UNIT PACKAGE: 15



**19248**

(1268176-3)  
Black Nylon

Bumper Cover  
Push-Type Retainer  
Head Diameter: 16mm  
Stem Length: 14mm  
Fits into 6mm Hole  
740 & 760 1993 - On

UNIT PACKAGE: 15



**19904**

(9133417-7)  
Black Nylon

Rocker Panel  
Push-Type Retainer  
Head Diameter: 16mm  
Stem Length: 14mm  
Fits into 9mm Hole  
850 Series 1994 - On

UNIT PACKAGE: 15



**20407**

(9133073-8)  
Black Nylon

Hood Insulation &  
Radiator Seal Push-Type Retainer  
Head Size: 8mm x 25mm  
Stem Length: 10mm  
Fits into 5mm Hole  
850, 940, 960, S80, S90 & V90 1991 - On

UNIT PACKAGE: 25



**13220**

(Mercedes 000-994-09-45;  
Volvo 946-418;  
Opel 20-72-175)  
Plated

U-Type Nut  
Screw Size: 6.3mm  
Panel Range: .7mm-1.5mm  
Center of Hole to Edge: 13mm

UNIT PACKAGE: 50

**UNIVERSAL EUROPEAN IMPORT FASTENERS**



**16132**

Black Nylon

Trim Panel Retainer  
Head Diameter: 19mm  
Stem Length: 20mm  
Fits into 8mm Hole

UNIT PACKAGE: 25



**16134**

Zinc & Yellow

Thread Cutting Nut with Sealer  
For 3mm Stud  
Outer Diameter: 13.5mm  
Hex: 8mm

UNIT PACKAGE: 25

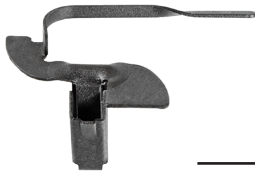

**9965**  
(GM: 1244839, 3944866)  
Moulding Fastener  
UNIT PACKAGE: 25

**12971**

Same as 9965 except for unit package quantity  
UNIT PACKAGE: 10



**2943**  
(4759145, 4761842, 4779348)  
Front and Rear Fender and  
Door Peak Moulding Fastener  
GM

UNIT PACKAGE: 50

**12966**

Same as 2943 except for unit package quantity  
UNIT PACKAGE: 15



**2744**  
(Chry: 1624705, 6010093)  
Moulding Fastener  
Bolt: #10-24 x 3/4"  
Plate Length: 3/4"  
Plate Width: 5/16"

UNIT PACKAGE: 50

**12959**

Same as 2744 except for unit package quantity  
UNIT PACKAGE: 15

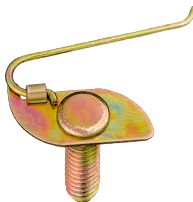

**2818**  
(GM: 4689929, 4778814)  
Moulding Fastener  
Bolt: #10-24 x 3/4"  
Plate Length: 3/4"  
Plate Width: 5/16"

UNIT PACKAGE: 50

**12962**

Same as 2818 except for unit package quantity  
UNIT PACKAGE: 15



**19626**  
(Ford: 358560;  
Chry: 1560058, 6010029;  
GM: 568792, 574355, 1165051)  
Moulding Fastener  
Bolt: #10-24 x 3/4"  
Plate Length: 1"  
Plate Width: 1/2"

**Replaces Auveco 2514**

UNIT PACKAGE: 25

**19627**

Same as 19626 except for unit package quantity  
UNIT PACKAGE: 15



**20175**  
(4637277, 4730773)  
Moulding Fastener  
#10-24 x 3/4"  
Plate Length: 1-5/8"  
Plate Width: 11/16"

**Replaces Auveco 2821**

UNIT PACKAGE: 25

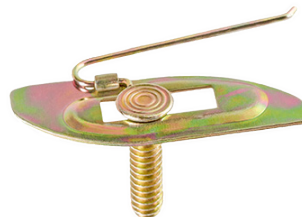

**2789**  
(GM: 575411, 4723818)

Moulding Fastener  
Bolt: #10-24 x 5/8"  
Plate Length: 1-5/8"  
Plate Width: 9/16"

UNIT PACKAGE: 50

**12961**

Same as 2789 except for unit package quantity  
UNIT PACKAGE: 15



**2619**  
(Chry: 6000705, 6013029;  
GM: 3722635)

Moulding Fastener  
Bolt: #10-24 x 3/4"  
Plate Length: 1-11/32"  
Plate Width: 1/2"

UNIT PACKAGE: 50

**12958**

Same as 2619 except for unit package quantity  
UNIT PACKAGE: 15



**2752**  
(GM: 3744999;  
Chry: 1758099,  
6000720, 6010046)

Moulding Fastener  
Bolt: #10-24 x 3/4"  
Plate Length: 1-25/32"  
Plate Width: 9/16"

UNIT PACKAGE: 50

**12960**

Same as 2752 except for unit package quantity  
UNIT PACKAGE: 15

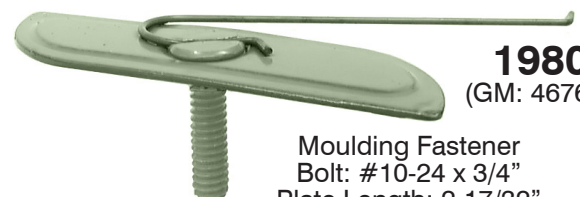

**19807**  
(GM: 4676189)

Moulding Fastener  
Bolt: #10-24 x 3/4"  
Plate Length: 2-17/32"  
Plate Width: 11/16"

**Replaces Auveco 2820**

UNIT PACKAGE: 15



**19378**  
Zinc

Universal Moulding  
Fastener  
Bolt: #10-24 x 3/4"  
Plate: 2-1/2" x 3/4"

Break off plate at 1/16" perforations to fit moulding  
**Replaces Auveco 2356**  
**Use with Auveco Hex Nut 730**

UNIT PACKAGE: 25



**8581**  
Nylon

Moulding Fastener  
Plate Length: 3"  
Plate Width: 3/4"

Break off plate at 5/32" perforations to fit moulding

UNIT PACKAGE: 10



**5889**

Universal Moulding Fastener  
For 5/16"-1/2" Moulding  
Fits into 3/8" Hole

UNIT PACKAGE: 50



**8843**  
Nylon

Moulding Fastener  
For 1/2"-5/8" Mouldings

UNIT PACKAGE: 50



**8447**  
(GM: 4886720, 4417599)  
Nylon

Front & Rear Door  
Moulding Fastener  
For 1/2" to 5/8" Moulding

UNIT PACKAGE: 50



**8448**  
(GM: 4879481)  
Nylon

Front & Rear Door  
Moulding Fastener  
For 3/4" to 1" Moulding

UNIT PACKAGE: 50



**8398**  
(GM: 4853108)  
Nylon

Front & Rear Door and  
Quarter Panel Moulding Fastener  
For 3/4" to 1" Moulding

UNIT PACKAGE: 25



**8385**  
(GM: 4877000)  
Nylon

Door & Fender Moulding Fastener  
For 3/4" to 1" Moulding

UNIT PACKAGE: 25

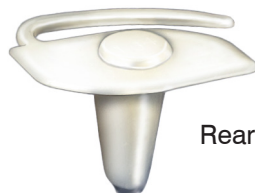

**8399**  
(GM: 4883164)  
Nylon

Rear Fender Lower Moulding Fastener  
For 7/8" to 1-1/4" Mouldings

UNIT PACKAGE: 25



**8386**  
(GM: 4877001)  
Nylon

Rear Fender Lower  
Moulding Fastener  
For 1" to 1-1/4" Moulding

UNIT PACKAGE: 25

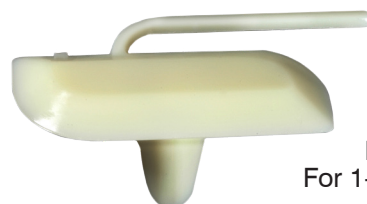

**8400**  
Nylon  
Moulding Fastener  
For 1-1/4" to 1-3/4" Moulding

UNIT PACKAGE: 25



*Photos not actual size*

## Rod End Ball Joints • Male

• **Bearing Raceway:**  
Locked in by annular groove-trunnion design.  
Made of fiber reinforced nylon.

• **Spherical Ball:**  
Precision made from selected low carbon steel-case hardened - file hard. Plated plus dichromate treated for corrosion resistance.

• **Outer Member (Housing):**  
Low carbon steel, plated plus dichromate treated for corrosion resistance.

• **Left Hand Thread:**  
Available with left hand thread in most sizes. Marked for easy user identification.

Only available fully assembled.

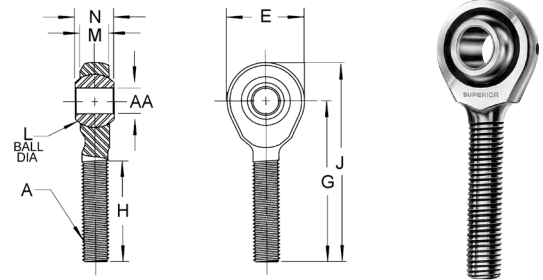

Auveco Part No.	Thread Size (A)	AA	E	G	H	J	L	M	N	Unit Pkg.	Thread
<b>12268</b>	10-32	.189	.625	1.250	.750	1.562	.438	.250	.312	1	R
<b>12269</b>		.191								1	L
<b>12270</b>	1/4-28	.250	.750	1.562	1.000	1.937	.516	.281	.375	1	R
<b>12271</b>		.252								1	L
<b>12021</b>	5/16-24	.3125	.875	1.875	1.250	2.312	.625	.344	.437	1	R
<b>12272</b>		.3145								1	L
<b>12022</b>	3/8-24	.375	1.000	1.937	1.250	2.437	.719	.406	.500	1	R
<b>12273</b>		.377								1	L
<b>12485</b>	7/16-20	.4395	1.125	2.125	1.312	2.687	.812	.437	.562	1	R
		.4375									
<b>12023</b>	1/2-20	.500	1.312	2.437	1.500	3.094	.938	.500	.625	1	R
<b>12274</b>		.502								1	L
<b>12024</b>	5/8-18	.625	1.500	2.625	1.625	3.375	1.125	.562	.750	1	R
<b>12486</b>	3/4-16	.752	1.750	2.875	1.750	3.750	1.312	.687	.875	1	R
		.750									

## Rod End Ball Joints • Female

• **Bearing Raceway:**  
Locked in by annular groove-trunnion design.  
Made of fiber reinforced nylon.

• **Spherical Ball:**  
Precision made from selected low carbon steel-case hardened - file hard. Plated plus dichromate treated for corrosion resistance.

• **Outer Member (Housing):**  
Low carbon steel, plated plus dichromate treated for corrosion resistance.

• **Left Hand Thread:**  
Available with left hand thread in most sizes. Marked for easy user identification.

Only available fully assembled.

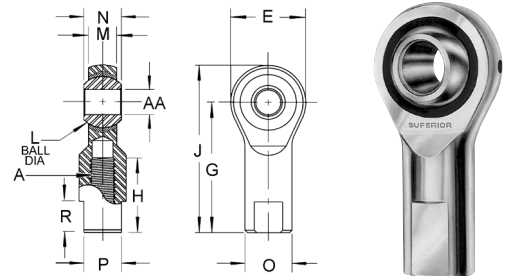

Auveco Part No.	Thread Size (A)	AA	E	G	H	J	L	M	N	O	P	R	Unit Pkg.	Thread
<b>12025</b>	10-32	.189	.625	1.062	.562	1.375	.438	.250	.312	.406	.312	.406	1	R
<b>12276</b>		.191											1	L
<b>12026</b>	1/4-28	.250	.750	1.312	.750	1.687	.516	.281	.375	.469	.375	.406	1	R
<b>12277</b>		.252											1	L
<b>12027</b>	5/16-24	.3125	.875	1.375	.750	1.812	.625	.344	.437	.500	.437	.500	1	R
<b>12278</b>		.3145											1	L
<b>12028</b>	3/8-24	.375	1.000	1.625	.937	2.125	.719	.406	.500	.687	.562	.562	1	R
<b>12279</b>		.377											1	L
<b>12487</b>	7/16-20	.4395	1.125	1.812	1.032	2.375	.812	.437	.562	.750	.625	.625	1	R
		.4375												
<b>12029</b>	1/2-20	.500	1.312	2.125	1.187	2.781	.938	.500	.625	.875	.750	.687	1	R
<b>12280</b>		.502											1	L
<b>12281</b>	5/8-18	.625	1.500	2.500	1.500	3.250	1.125	.562	.750	1.000	.875	.875	1	R
<b>12488</b>	3/4-16	.752	1.750	2.875	1.562	3.750	1.312	.687	.875	1.125	1.000	1.000	1	R
		.750												

*Photos not actual size*

**Rod End Ball Joints • Male with Stud**

• **Bearing Raceway:**  
Locked in by annular groove-trunnion design.  
Made of fiber reinforced nylon.

• **Spherical Ball:**  
Precision made from selected low carbon steel-case hardened - file hard. Plated plus dichromate treated for corrosion resistance.

• **Outer Member (Housing):**  
Low carbon steel, plated plus dichromate treated for corrosion resistance.

• **Left Hand Thread:**  
Available with left hand thread in most sizes. Marked for easy user identification.

Only available fully assembled.

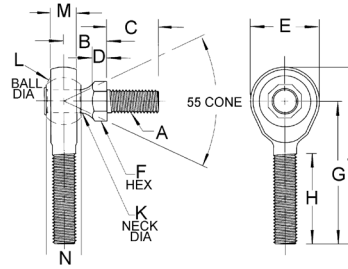

Auveco Part No.	Thread Size (A)	B	C	D	E	F	G	H	J	K	L	M	N	Unit Pkg.	Thread
12290	10-32	.437	.437	.156	.625	.312	1.250	.750	1.562	.189	.438	.250	.312	1	R
12292	1/4-28	.469	.562	.156	.750	.375	1.562	1.000	1.937	.250	.516	.281	.375	1	R
12293														1	L
12030	5/16-24	.531	.687	.187	.875	.437	1.875	1.250	2.312	.312	.625	.344	.437	1	R
12031	3/8-24	.625	.875	.218	1.000	.500	1.937	1.250	2.437	.375	.719	.406	.500	1	R
12295														1	L
12032	1/2-20	.875	1.125	.312	1.312	.625	2.437	1.500	3.094	.500	.938	.500	.625	1	R

**Rod End Ball Joints • Female with Stud**

• **Bearing Raceway:**  
Locked in by annular groove-trunnion design.  
Made of fiber reinforced nylon.

• **Spherical Ball:**  
Precision made from selected low carbon steel-case hardened - file hard. Plated plus dichromate treated for corrosion resistance.

• **Outer Member (Housing):**  
Low carbon steel, plated plus dichromate treated for corrosion resistance.

• **Left Hand Thread:**  
Available with left hand thread in most sizes. Marked for easy user identification.

Only available fully assembled.

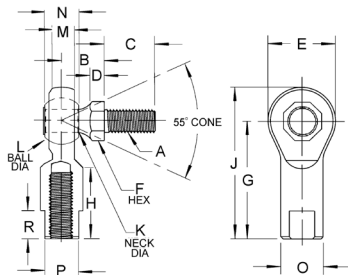

Auveco Part No.	Thread Size (A)	B	C	D	E	F	G	H	J	K	L	M	N	O	P	R	Unit Pkg.	Thread
12034	10-32	.437	.437	.156	.625	.312	1.062	.562	1.375	.189	.438	.250	.312	.406	.312	.406	1	R
12283																	1	L
12035	1/4-28	.469	.562	.156	.750	.375	1.312	.750	1.687	.250	.516	.281	.375	.469	.375	.406	1	R
12284																	1	L
12036	5/16-24	.531	.687	.187	.875	.437	1.375	.750	1.812	.312	.625	.344	.437	.500	.437	.500	1	R
12285																	1	L
12037	3/8-24	.625	.875	.218	1.000	.500	1.625	.937	2.125	.375	.719	.406	.500	.687	.562	.562	1	R
12286																	1	L
12491	7/16-20	.844	1.062	.312	1.125	.625	1.812	1.032	2.375	.437	.812	.437	.562	.750	.625	.625	1	R
12038	1/2-20	.875	1.125	.312	1.312	.625	2.125	1.187	2.781	.500	.938	.500	.625	.875	.750	.687	1	R
12288	5/8-18	1.00	1.125	.375	1.500	.750	2.500	1.500	3.250	.625	1.125	.562	.750	1.00	.875	.875	1	R
12492	3/4-16	1.187	1.812	.375	1.750	1.00	2.875	1.562	3.750	.750	1.312	.687	.875	1.125	1.00	1.00	1	R

*Photos not actual size*

## Damper Control Swivels

The units are made from low carbon steel and are plated and dichromate treated for corrosion resistance. The set screws are made of low carbon steel, plated and dichromate treated for corrosion resistance.

Set screws are case hardened.

A rubber disc is used in the assembly.

Only available fully assembled

Thread Size	Damper Control Swivels			
	Auveco Part No. w/o Nut & Washer	Unit Pkg.	Auveco Part No. with Nut & Washer	Unit Pkg.
1/4-28 x 9/16"	<b>12303</b>	2	<b>12047</b>	3
1/4-20 x 9/16"	<b>12305</b>	2	<b>12049</b>	3

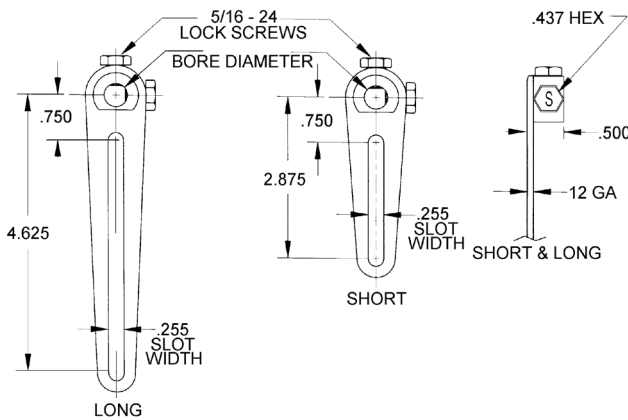
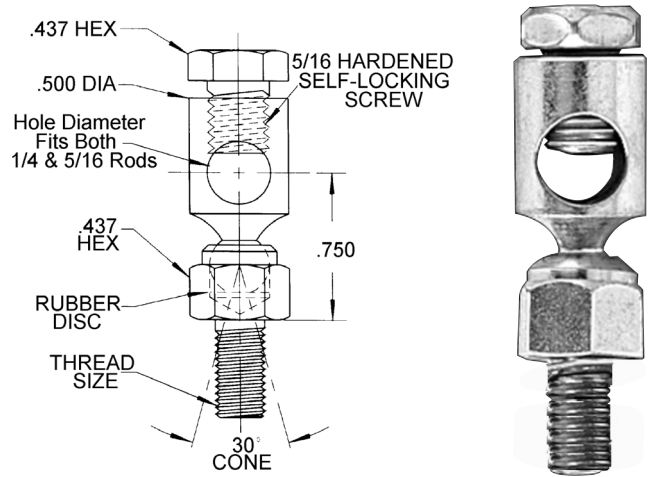

## Crank Arms

12 Gauge Steel

**12050**

Short Series Crank Arm  
For 3/8" Shaft  
Bore Diameter: .385/.389

UNIT PACKAGE: 1



## Lightweight Ball Joint Assemblies

**Materials of construction:** Made of low carbon steel. Units are plated and dichromate treated for corrosion resistance. A rubber disc is used.

Only available fully assembled.

Auveco Part No.	Unit Pkg.	G.M.C. Part No.	A	B	C	D	E	F
<b>21533</b>	2	443773	1/4-28	2-3/32	9/16	7/16	5/16	9/16

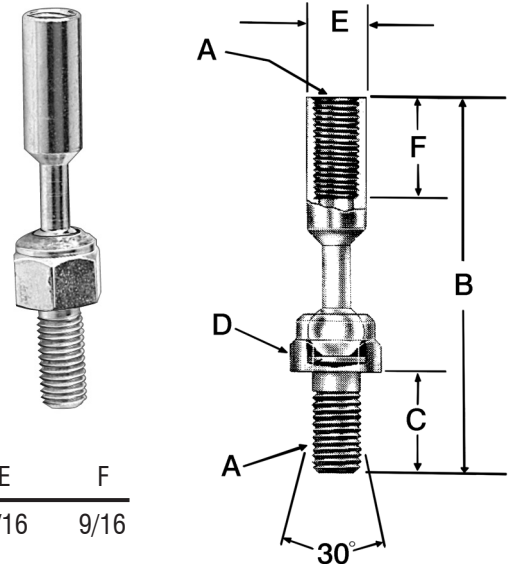

“Flat Top” • Shurseal



**Materials of construction:**  
Made of low carbon steel with ball studs case hardened. Plated and dichromate treated for corrosion resistance.

Only available fully assembled.

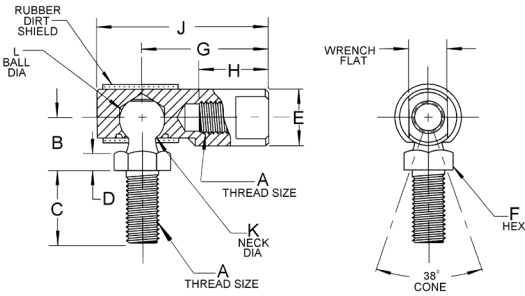

Auveco Part No.	A	B	C	D	E	Wrench Size	F	G	H	J	K	L	Unit Pkg.	Thread
13580	10-32	7/16	7/16	1/8	3/8	5/16	5/16	7/8	15/32	1-5/32	.177	.301	2	R
12039	1/4-28	15/32	9/16	1/8	7/16	3/8	3/8	31/32	17/32	1-5/16	.208	.347	3	R
12040	5/16-24	17/32	11/16	5/32	1/2	7/16	7/16	1-1/8	19/32	1-9/16	.250	.405	3	R
13590													2	L
12041	3/8-24	11/16	7/8	3/16	5/8	1/2	1/2	1-3/8	13/16	1-13/16	.289	.493	1	R
12042	7/16-20	7/8	1-1/8	1/4	3/4	5/8	5/8	1-15/16	1-1/8	2-1/2	.375	.618	1	R

Quick Disconnect

“Key Hole” design on retaining sleeve insures positive alignment of sleeve with ball cavity.

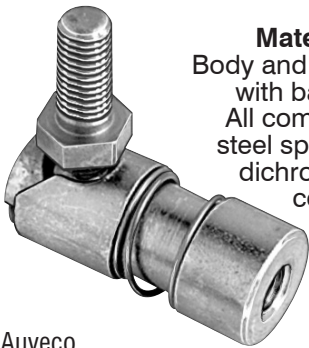

**Materials of construction:**  
Body and ball are of low carbon steel, with ball studs case hardened. All components except stainless steel spring are plated and yellow dichromate treated for greater corrosion resistance.

Only available fully assembled.

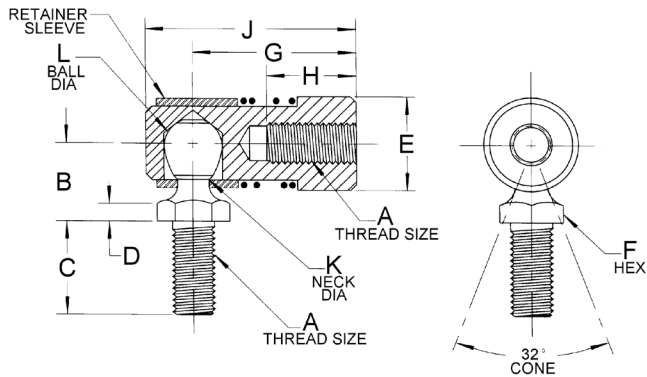

Auveco Part No.	A	B	C	D	E	F	G	H	J	K	L	Unit Pkg.
12044	1/4-28	15/32	9/16	1/8	9/16	3/8	31/32	17/32	1-1/4	.192	.347	2
12045	5/16-24	17/32	11/16	5/32	5/8	7/16	1-1/8	19/32	1-29/64	.224	.405	2
13610	3/8-24	11/16	7/8	3/16	3/4	1/2	1-3/8	13/16	1-3/4	.273	.493	1

Disconnecting

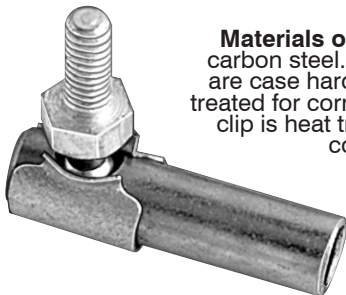

**Materials of construction:** Made of low carbon steel. Both ball stud and ball cavity are case hardened. Plated and dichromate treated for corrosion resistance. The retaining clip is heat treated spring steel, plated for corrosion resistance.

Only available fully assembled.

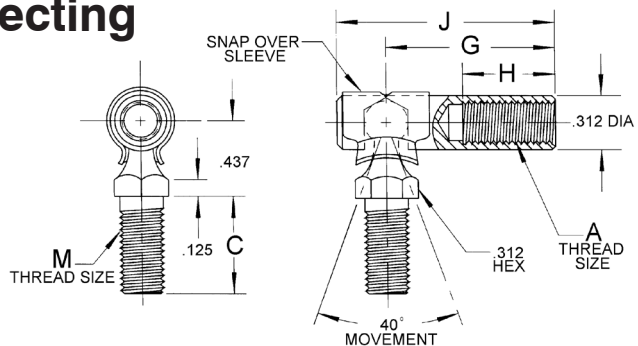

Auveco Part No.	A	C	G	H	J	M	Unit Pkg.
13599	10-32NF	7/16	7/8	31/64	1-5/32	10-32NF	2
13601	10-32NF	9/16	7/8	31/64	1-5/32	1/4-28UNF	2
13600	1/4-28UNF	9/16	31/32	17/32	1-1/4	1/4-28UNF	2



## “Flat Top”

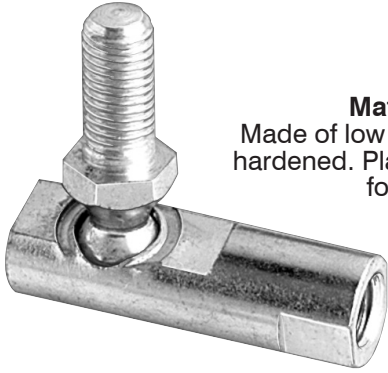

**Materials of construction:**  
 Made of low carbon steel with ball studs case hardened. Plated and clear dichromate treated for corrosion resistance.

Only available fully assembled.

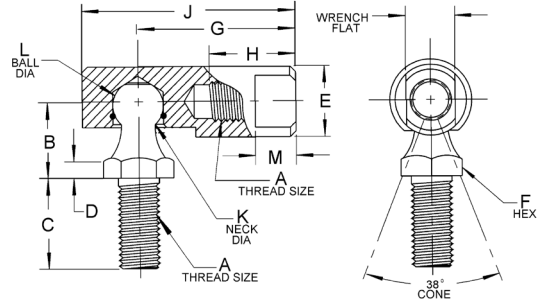

Auveco Part No.	A	B	C	D	E	Wrench Size	F	G	H	J	K	L	Unit Pkg.	Thread
13581	10-32	7/16	7/16	1/8	3/8	5/16	5/16	7/8	15/32	1-5/32	.177	.301	2	R
13582	1/4-28	15/32	9/16	1/8	7/16	3/8	3/8	31/32	17/32	1-5/16	.208	.347	2	R
13584	5/16-24	17/32	11/16	5/32	1/2	7/16	7/16	1-1/8	19/32	1-9/16	.250	.405	2	R
9869	3/8-24	11/16	7/8	3/16	5/8	1/2	1/2	1-3/8	13/16	1-13/16	.289	.493	5	R
13587	1/2-20	7/8	1-1/8	1/4	3/4	5/8	5/8	1-15/16	1-1/8	2-1/2	.375	.618	1	R

## YOKE ENDS

Zinc finished Drop Forged Yoke Ends • Adjustable

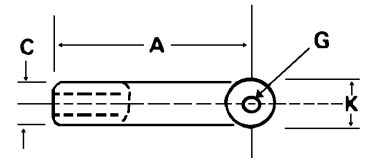
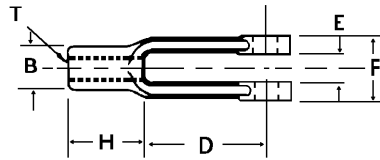
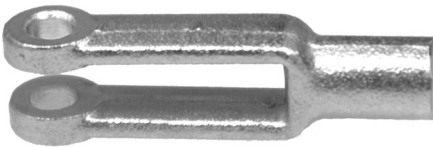

Auveco Part No.	“T” Tap Size	Dimensions in Inches									Unit Pkg.
		A	B	C	D	E	F	G	H	K	
10737	1/4-28	2	7/16	7/16	1-1/4	9/32	5/8	1/4	3/4	1/2	10
10788	1/4-28	2	7/16	7/16	1-1/4	9/32	5/8	1/4	3/4	1/2	2
10738	5/16-24	2-1/4	1/2	1/2	1-7/16	11/32	3/4	5/16	13/16	19/32	10
10789	5/16-24	2-1/4	1/2	1/2	1-7/16	11/32	3/4	5/16	13/16	19/32	2
10739	3/8-24	2-1/2	5/8	5/8	1-5/8	7/16	7/8	3/8	7/8	11/16	10
10790	3/8-24	2-1/2	5/8	5/8	1-5/8	7/16	7/8	3/8	7/8	11/16	2
10740	7/16-20	2-7/8	23/32	23/32	1-7/8	1/2	1	7/16	1	13/16	10
10791	7/16-20	2-7/8	23/32	23/32	1-7/8	1/2	1	7/16	1	13/16	2
10741	1/2-20	3	13/16	13/16	1-7/8	9/16	1-1/8	1/2	1-1/8	15/16	10
10792	1/2-20	3	13/16	13/16	1-7/8	9/16	1-1/8	1/2	1-1/8	15/16	2
10742	5/8-18	4-15/16	1-1/16	1-1/16	3-11/16	11/16	1-3/8	5/8	1-1/4	1-3/16	10
10793	5/8-18	4-15/16	1-1/16	1-1/16	3-11/16	11/16	1-3/8	5/8	1-1/4	1-3/16	2

# Sec. 25

# HOSE CLAMPS



**Single Bond  
Hose Clamps**  
Black Nylon

Auveco Part No.	Size	Clamping Range		Unit Pkg.
		Min.	Max.	
19558	1/4"	.246	.290	25
19559	5/16"	.300	.350	25
19560	11/32"	.360	.406	25
19561	13/32"	.410	.468	25
19562	15/32"	.475	.536	25
19564	19/32"	.597	.665	25
19566	3/4"	.730	.830	25
19568	61/64"	.953	1.093	25
19569	1-1/32"	1.031	1.187	25
19570	1-1/4"	1.250	1.425	10
19571	1-13/32"	1.406	1.610	10
19572	1-19/32"	1.593	1.812	10
19575	2-1/8"	2.120	2.390	10



## Spring Action Hose Clamps

Spring Steel • Heat Treated  
Phosphate and Paint

Auveco Part No.	Hose O.D.	Color	Max. Dia. Clamp in Free Position	Width	Unit Pkg.
12682	3/8"	Black	.321	5/16"	100
12683	7/16"	Green	.405	5/16"	100
12684	1/2"	Red	.460	5/16"	100
12685	9/16"	Black	.520	5/16"	100
12686	5/8"	Olive	.583	5/16"	100
12688	11/16"	Red	.655	5/16"	100
12689	3/4"	Black	.645	3/8"	100

## Crimp Type Hose Clamp Tool

**18448**

*Photo not actual size*

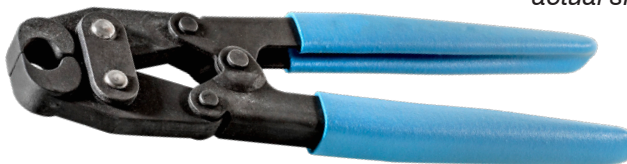

For installing and removing  
Auveco Crimp Type Hose Clamps 18436-18447.

UNIT PACKAGE: 1

## Crimp Type Hose Clamps

Zinc Plated

*Photos not actual size*

- For low pressure applications such as automotive, appliance, industrial machinery, etc.
- Easy to apply
- Simply slide on and clamp
- Sizes for all Hoses
- Ideal for Mass Production
- Clamps Tight
- Clamps Quickly
- Only one simple motion needed
- "Full Round" Clamping Pressure
- No gap areas to leak
- Low profile-out of the way
- Avoids Hose cutting and abrasion



Position clamp on hose

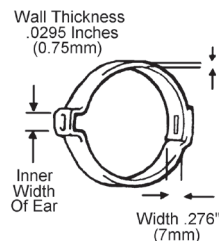

Firmly squeeze ear



Auveco Part No.	Nominal Size	Inches		MM		Inner Width of Ear		Unit Pkg.
		Closed-Open	Closed-Open	Inches	MM			
18436	3/8"	.350 - .414	8.9 - 10.5	.197	5	25		
18437	7/16"	.381 - .444	9.7 - 11.3	.197	5	25		
18438	15/32"	.394 - .486	10.4 - 12.3	.197	6	25		
18439	1/2"	.453 - .524	11.4 - 13.3	.236	6	25		
18440	35/64"	.472 - .551	11.9 - 14.0	.256	6.5	25		
18441	9/16"	.496 - .571	12.6 - 14.5	.236	6	25		
18442	5/8"	.543 - .618	13.8 - 15.7	.236	6	25		
18443	11/16"	.594 - .669	15.1 - 17.0	.236	6	25		
18444	23/32"	.618 - .728	15.7 - 18.5	.354	9	25		
18445	3/4"	.669 - .779	17.0 - 19.8	.354	9	25		
18446	7/8"	.779 - .890	19.8 - 22.6	.354	9	25		
18447	1"	.898 - 1.008	22.8 - 25.6	.354	9	25		



## Constant Tension Band Hose Clamps

For Heater & Radiator Hoses  
 1074 Spring Steel • Black OEM Finish  
 Conforms to SAE J1508 & GM 6298M  
 Rated at 30 P.S.I.

Auveco Part No.	Clamping Range	Band Width	Unit Pkg.
<b>18127</b>	15.2mm - 18.5mm (5/8" - 23/32")	15mm (19/32")	10
<b>18128</b>	17.8mm - 20.0mm (23/32" - 25/32")	15mm (19/32")	10
<b>18129</b>	22.0mm - 26.0mm (7/8" - 1")	15mm (19/32")	10
<b>18132</b>	37.2mm - 44.5mm (1-15/32" - 1-3/4")	15mm (19/32")	5



## Wire Type Hose Clamps

To Install and remove wire type hose clamps use Auveco Tool 20902 (See page 849)

Auveco Part No.	Hose Size O.D.	Unit Pkg.
<b>5354</b>	9/16"	50
<b>5357</b>	3/4"	50
<b>17086</b>	13/16"	50
<b>5358</b>	15/16"	50
<b>16603</b>	1-7/8"	10
<b>16604</b>	2"	10



## 9324

Mini Clamp  
 Stainless Steel Band with  
 Double Plated Hex Head Steel Screw  
 Band Width: 5/16"  
 Minimum Range 1/4" - Maximum Range 5/8"

UNIT PACKAGE: 10



## 10221

Mini Clamp  
 Stainless Steel Band with Double  
 Plated Slotted Head Steel Screw  
 Band Width: 5/16"  
 Minimum Range 1/2" - Maximum Range 7/8"

UNIT PACKAGE: 10



## Hex Slotted Screw-Worm Gear Type-Hose Clamps

Stainless Steel  
 Band Saddle Screw Housing  
 300 Series Stainless (Non-Corrosive)  
 Screw is 400 Series (Magnetic) Stainless

Auveco Part No.	Inside Std. Size	Clamp Range Min.-Max	Hose I.D. 3/16" Wall	Fits Plastic Pipe Size	Band Width	Unit Pkg.
<b>9584</b>	8	7/16" - 1"	5/16" to 1/2"	1/2" to 9/16"	9/16"	10
<b>9585</b>	10	1/2" - 1-1/8"	3/8" to 5/8"	1/2" to 3/4"	9/16"	10
<b>9586</b>	12	1/2" - 1-1/4"	5/8" to 3/4"	1/2" to 3/4"	9/16"	10
<b>18483</b>	16	3/4" - 1-1/2"	3/4" to 7/8"	1" to 1-1/4"	9/16"	10
<b>9587</b>	20	3/4" - 1-3/4"	1" to 1-1/4"	1" to 1-1/4"	9/16"	10
<b>9588</b>	24	1" - 2"	1-1/4" to 1-1/2"	1" to 1-1/2"	9/16"	10
<b>9589</b>	28	1-5/16" - 2-1/4"	1-1/4" to 1-3/4"	1-1/4" to 1-1/2"	9/16"	10
<b>9590</b>	32	1-9/16" - 2-1/2"	1-1/2" to 2"	1-1/2" to 2"	9/16"	10
<b>9591</b>	36	7/8" - 2-3/4"	1-3/4" to 2-1/4"	1-1/2" to 2"	9/16"	10
<b>9592</b>	40	1-1/8" - 3"	2" to 2-1/2"	2" to 2-1/2"	9/16"	10
<b>9593</b>	48	1-5/8" - 3-1/2"	2-1/4" to 3"	2-5/8" to 3"	9/16"	10
<b>9594</b>	52	1-7/8" - 3-3/4"	2-13/16" to 3-3/4"	3"	9/16"	10
<b>9595</b>	72	3-1/8" - 5"	3-3/4" to 4-1/2"		9/16"	10
<b>9596</b>	88	4-1/4" - 6"	4" to 5-1/2"	4"	9/16"	10
<b>9597</b>	96	4-3/4" - 6-1/2"	4-1/2" to 6"		9/16"	10
<b>9598</b>	104	5" - 7"	5-7/8" to 6-1/2"	6"	9/16"	10