

# AuvecoPak AP448 Retail Merchandiser Contents

## Part Number Location Chart

| <b>Auveco Pak No.</b> | <b>Location</b> |       |            |
|-----------------------|-----------------|-------|------------|
| AP10744               | Panel U1        | Row 6 | Position 2 |
| AP10823               | Panel X2        | Row 2 | Position 1 |
| AP10831               | Panel T1        | Row 1 | Position 2 |
| AP10832               | Panel T1        | Row 1 | Position 1 |
| AP11067               | Panel Y2        | Row 6 | Position 4 |
| AP11109               | Panel X2        | Row 3 | Position 2 |
| AP11110               | Panel X2        | Row 3 | Position 3 |
| AP11120               | Panel T1        | Row 2 | Position 2 |
| AP11130               | Panel T2        | Row 1 | Position 4 |
| AP11146               | Panel T1        | Row 1 | Position 3 |
| AP11152               | Panel Y2        | Row 4 | Position 2 |
| AP11243               | Panel Y1        | Row 8 | Position 4 |
| AP11292               | Panel Z2        | Row 1 | Position 3 |
| AP11320               | Panel X2        | Row 2 | Position 4 |
| AP11351               | Panel T1        | Row 6 | Position 4 |
| AP11369               | Panel Y1        | Row 4 | Position 1 |
| AP11612               | Panel T1        | Row 3 | Position 1 |
| AP11620               | Panel W1        | Row 1 | Position 1 |
| AP11621               | Panel W1        | Row 1 | Position 2 |
| AP11625               | Panel Z1        | Row 3 | Position 1 |
| AP11626               | Panel Z1        | Row 3 | Position 2 |
| AP11628               | Panel Z1        | Row 4 | Position 4 |
| AP11629               | Panel Z1        | Row 5 | Position 1 |
| AP11630               | Panel Z1        | Row 5 | Position 2 |
| AP11631               | Panel Z1        | Row 5 | Position 3 |
| AP11633               | Panel X2        | Row 5 | Position 2 |
| AP11655               | Panel Y1        | Row 8 | Position 2 |
| AP11671               | Panel T2        | Row 3 | Position 1 |
| AP11672               | Panel T2        | Row 6 | Position 1 |
| AP11678               | Panel T2        | Row 5 | Position 4 |
| AP11679               | Panel T1        | Row 4 | Position 1 |
| AP11691               | Panel W1        | Row 6 | Position 4 |
| AP11699               | Panel U1        | Row 8 | Position 1 |
| AP11705               | Panel U1        | Row 7 | Position 4 |
| AP11706               | Panel U1        | Row 8 | Position 3 |
| AP11719               | Panel W2        | Row 1 | Position 1 |
| AP11721               | Panel T1        | Row 3 | Position 2 |
| AP11746               | Panel Z2        | Row 6 | Position 1 |
| AP11788               | Panel X1        | Row 3 | Position 2 |
| AP11789               | Panel X1        | Row 3 | Position 3 |
| AP11791               | Panel X1        | Row 3 | Position 4 |
| AP11792               | Panel X1        | Row 4 | Position 1 |
| AP11796               | Panel T2        | Row 7 | Position 1 |
| AP11797               | Panel T2        | Row 4 | Position 2 |
| AP11826               | Panel Y1        | Row 8 | Position 3 |
| AP11855               | Panel W1        | Row 6 | Position 1 |
| AP11863               | Panel T2        | Row 7 | Position 3 |
| AP11914               | Panel Y1        | Row 6 | Position 4 |
| AP11922               | Panel X1        | Row 7 | Position 4 |
| AP12060               | Panel X1        | Row 5 | Position 2 |
| AP12065               | Panel X2        | Row 4 | Position 4 |
| AP12066               | Panel X2        | Row 5 | Position 1 |
| AP12067               | Panel X2        | Row 4 | Position 2 |
| AP12095               | Panel X2        | Row 6 | Position 4 |
| AP12127               | Panel W2        | Row 8 | Position 4 |
| AP12134               | Panel T2        | Row 8 | Position 2 |

| <b>Auveco Pak No.</b> | <b>Location</b> |       |            |
|-----------------------|-----------------|-------|------------|
| AP12137               | Panel T1        | Row 7 | Position 2 |
| AP12160               | Panel X2        | Row 4 | Position 3 |
| AP12213               | Panel X1        | Row 1 | Position 1 |
| AP12214               | Panel X1        | Row 1 | Position 2 |
| AP12215               | Panel X1        | Row 1 | Position 3 |
| AP12216               | Panel X1        | Row 1 | Position 4 |
| AP12217               | Panel X1        | Row 2 | Position 1 |
| AP12218               | Panel X1        | Row 2 | Position 2 |
| AP12255               | Panel W2        | Row 3 | Position 3 |
| AP12324               | Panel X2        | Row 3 | Position 4 |
| AP12335               | Panel Y1        | Row 6 | Position 2 |
| AP12339               | Panel X2        | Row 1 | Position 4 |
| AP12348               | Panel X2        | Row 5 | Position 4 |
| AP12351               | Panel X2        | Row 1 | Position 3 |
| AP12565               | Panel T2        | Row 2 | Position 2 |
| AP12567               | Panel U2        | Row 1 | Position 1 |
| AP12571               | Panel T1        | Row 8 | Position 1 |
| AP12575               | Panel Z1        | Row 4 | Position 3 |
| AP12595               | Panel W1        | Row 5 | Position 2 |
| AP12652               | Panel V2        | Row 6 | Position 4 |
| AP12653               | Panel W1        | Row 1 | Position 4 |
| AP12655               | Panel W1        | Row 1 | Position 3 |
| AP12669               | Panel Z1        | Row 3 | Position 4 |
| AP12693               | Panel X2        | Row 4 | Position 1 |
| AP12731               | Panel T1        | Row 4 | Position 4 |
| AP12737               | Panel T2        | Row 6 | Position 4 |
| AP12741               | Panel X1        | Row 8 | Position 1 |
| AP12742               | Panel X1        | Row 8 | Position 2 |
| AP12757               | Panel U2        | Row 1 | Position 4 |
| AP12759               | Panel T2        | Row 1 | Position 2 |
| AP12766               | Panel T1        | Row 5 | Position 4 |
| AP12820               | Panel X1        | Row 5 | Position 1 |
| AP12909               | Panel T1        | Row 8 | Position 2 |
| AP12953               | Panel X1        | Row 2 | Position 3 |
| AP12954               | Panel X1        | Row 2 | Position 4 |
| AP12957               | Panel X1        | Row 3 | Position 1 |
| AP12992               | Panel T2        | Row 3 | Position 3 |
| AP13004               | Panel W1        | Row 3 | Position 1 |
| AP13007               | Panel W1        | Row 2 | Position 2 |
| AP13008               | Panel W1        | Row 2 | Position 4 |
| AP13009               | Panel W1        | Row 2 | Position 3 |
| AP13010               | Panel W1        | Row 3 | Position 2 |
| AP13014               | Panel W1        | Row 4 | Position 1 |
| AP13016               | Panel W1        | Row 4 | Position 2 |
| AP13017               | Panel W1        | Row 4 | Position 3 |
| AP13026               | Panel X1        | Row 4 | Position 3 |
| AP13027               | Panel X2        | Row 7 | Position 4 |
| AP13225               | Panel Z2        | Row 1 | Position 2 |
| AP13232               | Panel W1        | Row 4 | Position 4 |
| AP13450               | Panel W1        | Row 7 | Position 2 |
| AP13461               | Panel T2        | Row 6 | Position 2 |
| AP13470               | Panel T2        | Row 2 | Position 3 |
| AP13613               | Panel X2        | Row 5 | Position 3 |
| AP13614               | Panel X2        | Row 6 | Position 1 |
| AP13708               | Panel X2        | Row 7 | Position 1 |
| AP13748               | Panel V2        | Row 1 | Position 1 |

# AuvecoPak AP448

## Retail Merchandiser Contents

Sec. 15

### Part Number Location Chart

| Auveco Pak No. | Location |       |            | Auveco Pak No. | Location |       |            |
|----------------|----------|-------|------------|----------------|----------|-------|------------|
| AP13750        | Panel V2 | Row 2 | Position 2 | AP15367        | Panel T1 | Row 3 | Position 3 |
| AP13751        | Panel V2 | Row 2 | Position 1 | AP15373        | Panel X1 | Row 8 | Position 4 |
| AP13752        | Panel V2 | Row 2 | Position 4 | AP15456        | Panel T2 | Row 1 | Position 3 |
| AP13753        | Panel V2 | Row 3 | Position 1 | AP15457        | Panel T2 | Row 1 | Position 1 |
| AP13755        | Panel V2 | Row 1 | Position 2 | AP15461        | Panel T2 | Row 5 | Position 3 |
| AP13932        | Panel W1 | Row 8 | Position 1 | AP15479        | Panel T1 | Row 8 | Position 3 |
| AP13933        | Panel W1 | Row 7 | Position 4 | AP15480        | Panel T1 | Row 7 | Position 4 |
| AP13960        | Panel W1 | Row 7 | Position 3 | AP15481        | Panel T1 | Row 7 | Position 3 |
| AP13993        | Panel U2 | Row 7 | Position 4 | AP15518        | Panel Z2 | Row 4 | Position 2 |
| AP13994        | Panel V1 | Row 2 | Position 1 | AP15543        | Panel T1 | Row 6 | Position 1 |
| AP13996        | Panel U2 | Row 7 | Position 3 | AP15677        | Panel Z1 | Row 1 | Position 2 |
| AP14010        | Panel U2 | Row 1 | Position 3 | AP15695        | Panel Y2 | Row 2 | Position 4 |
| AP14011        | Panel U2 | Row 1 | Position 2 | AP15711        | Panel W2 | Row 3 | Position 4 |
| AP14016        | Panel U1 | Row 6 | Position 4 | AP15752        | Panel Z1 | Row 8 | Position 3 |
| AP14019        | Panel V1 | Row 2 | Position 3 | AP15774        | Panel X1 | Row 4 | Position 2 |
| AP14020        | Panel V1 | Row 2 | Position 4 | AP15775        | Panel X1 | Row 8 | Position 3 |
| AP14021        | Panel T1 | Row 2 | Position 4 | AP15970        | Panel T2 | Row 3 | Position 2 |
| AP14023        | Panel V2 | Row 1 | Position 3 | AP15998        | Panel T1 | Row 8 | Position 4 |
| AP14032        | Panel T1 | Row 5 | Position 2 | AP16000        | Panel V1 | Row 4 | Position 2 |
| AP14036        | Panel T1 | Row 5 | Position 3 | AP16251        | Panel W1 | Row 3 | Position 4 |
| AP14127        | Panel V2 | Row 6 | Position 3 | AP16253        | Panel W1 | Row 3 | Position 3 |
| AP14163        | Panel U1 | Row 4 | Position 4 | AP16322        | Panel Z1 | Row 4 | Position 2 |
| AP14260        | Panel V1 | Row 3 | Position 4 | AP16323        | Panel X1 | Row 6 | Position 3 |
| AP14267        | Panel W2 | Row 3 | Position 1 | AP16421        | Panel X2 | Row 1 | Position 2 |
| AP14274        | Panel W1 | Row 8 | Position 2 | AP16622        | Panel U2 | Row 7 | Position 2 |
| AP14291        | Panel U1 | Row 2 | Position 2 | AP16695        | Panel T2 | Row 5 | Position 2 |
| AP14298        | Panel Z2 | Row 4 | Position 3 | AP16782        | Panel U1 | Row 7 | Position 2 |
| AP14313        | Panel W1 | Row 8 | Position 3 | AP16784        | Panel U1 | Row 7 | Position 3 |
| AP14328        | Panel U1 | Row 6 | Position 1 | AP16818        | Panel T1 | Row 4 | Position 3 |
| AP14355        | Panel U1 | Row 2 | Position 1 | AP16826        | Panel Y1 | Row 5 | Position 3 |
| AP14356        | Panel U1 | Row 1 | Position 2 | AP16834        | Panel V2 | Row 4 | Position 1 |
| AP14473        | Panel Y1 | Row 4 | Position 4 | AP16835        | Panel V1 | Row 7 | Position 4 |
| AP14546        | Panel Z2 | Row 5 | Position 1 | AP16842        | Panel Z1 | Row 4 | Position 1 |
| AP14547        | Panel Z2 | Row 5 | Position 2 | AP16846        | Panel Z1 | Row 3 | Position 3 |
| AP14550        | Panel Y2 | Row 8 | Position 1 | AP16858        | Panel V1 | Row 5 | Position 2 |
| AP14553        | Panel Y2 | Row 8 | Position 2 | AP16864        | Panel V2 | Row 5 | Position 3 |
| AP14559        | Panel Y2 | Row 7 | Position 4 | AP16936        | Panel Y2 | Row 8 | Position 3 |
| AP14642        | Panel Y2 | Row 4 | Position 1 | AP16937        | Panel Y2 | Row 8 | Position 4 |
| AP14695        | Panel W2 | Row 1 | Position 3 | AP16960        | Panel Y1 | Row 4 | Position 3 |
| AP14696        | Panel V1 | Row 3 | Position 2 | AP17004        | Panel U1 | Row 4 | Position 3 |
| AP14697        | Panel V1 | Row 3 | Position 3 | AP17006        | Panel V2 | Row 4 | Position 3 |
| AP14736        | Panel U1 | Row 2 | Position 4 | AP17034        | Panel Y1 | Row 6 | Position 1 |
| AP14737        | Panel U1 | Row 3 | Position 1 | AP17057        | Panel V1 | Row 6 | Position 4 |
| AP14738        | Panel U1 | Row 4 | Position 2 | AP17075        | Panel T2 | Row 4 | Position 4 |
| AP14750        | Panel Z1 | Row 5 | Position 4 | AP17098        | Panel Y1 | Row 3 | Position 2 |
| AP14753        | Panel V1 | Row 6 | Position 2 | AP17101        | Panel V2 | Row 2 | Position 3 |
| AP14921        | Panel T1 | Row 2 | Position 3 | AP17103        | Panel U2 | Row 7 | Position 1 |
| AP14992        | Panel V1 | Row 6 | Position 1 | AP17121        | Panel V2 | Row 5 | Position 4 |
| AP14994        | Panel V1 | Row 8 | Position 2 | AP17143        | Panel V1 | Row 7 | Position 3 |
| AP14997        | Panel V1 | Row 5 | Position 1 | AP17144        | Panel V1 | Row 8 | Position 3 |
| AP15042        | Panel V1 | Row 3 | Position 1 | AP17162        | Panel U1 | Row 7 | Position 1 |
| AP15044        | Panel V1 | Row 2 | Position 2 | AP17216        | Panel V1 | Row 1 | Position 4 |
| AP15170        | Panel Y1 | Row 5 | Position 4 | AP17222        | Panel U2 | Row 6 | Position 3 |
| AP15172        | Panel X2 | Row 7 | Position 2 | AP17267        | Panel V1 | Row 4 | Position 4 |
| AP15326        | Panel W1 | Row 5 | Position 1 | AP17315        | Panel Y1 | Row 5 | Position 1 |
| AP15335        | Panel W1 | Row 5 | Position 3 | AP17316        | Panel Y1 | Row 5 | Position 2 |

# AuvecoPak AP448 Retail Merchandiser Contents

## Part Number Location Chart

| <b>Auveco Pak No.</b> | <b>Location</b> |       |            |
|-----------------------|-----------------|-------|------------|
| AP17339               | Panel U1        | Row 5 | Position 1 |
| AP17379               | Panel V1        | Row 4 | Position 1 |
| AP17410               | Panel V2        | Row 6 | Position 1 |
| AP17439               | Panel V1        | Row 5 | Position 4 |
| AP17459               | Panel X1        | Row 5 | Position 4 |
| AP17472               | Panel V1        | Row 6 | Position 3 |
| AP17612               | Panel T1        | Row 3 | Position 4 |
| AP17615               | Panel V2        | Row 4 | Position 2 |
| AP17632               | Panel V1        | Row 4 | Position 3 |
| AP17639               | Panel V2        | Row 7 | Position 1 |
| AP17649               | Panel T2        | Row 2 | Position 1 |
| AP17650               | Panel X1        | Row 4 | Position 4 |
| AP17664               | Panel T1        | Row 1 | Position 4 |
| AP17975               | Panel U1        | Row 3 | Position 4 |
| AP17980               | Panel Y1        | Row 3 | Position 3 |
| AP18033               | Panel U1        | Row 5 | Position 4 |
| AP18108               | Panel V2        | Row 1 | Position 4 |
| AP18114               | Panel T2        | Row 8 | Position 4 |
| AP18119               | Panel V1        | Row 8 | Position 1 |
| AP18153               | Panel W1        | Row 5 | Position 4 |
| AP18167               | Panel W1        | Row 2 | Position 1 |
| AP18297               | Panel U1        | Row 2 | Position 3 |
| AP18301               | Panel T1        | Row 5 | Position 1 |
| AP18340               | Panel X1        | Row 5 | Position 3 |
| AP18353               | Panel U1        | Row 8 | Position 4 |
| AP18354               | Panel X2        | Row 1 | Position 1 |
| AP18461               | Panel V2        | Row 4 | Position 4 |
| AP18842               | Panel U1        | Row 3 | Position 3 |
| AP18848               | Panel T2        | Row 2 | Position 4 |
| AP18873               | Panel V1        | Row 1 | Position 1 |
| AP18877               | Panel U1        | Row 5 | Position 3 |
| AP18888               | Panel U2        | Row 3 | Position 4 |
| AP18915               | Panel T2        | Row 4 | Position 1 |
| AP18930               | Panel T2        | Row 4 | Position 3 |
| AP19113               | Panel U1        | Row 3 | Position 2 |
| AP19114               | Panel U1        | Row 1 | Position 1 |
| AP19118               | Panel U2        | Row 3 | Position 2 |
| AP19140               | Panel V1        | Row 7 | Position 1 |
| AP19171               | Panel U1        | Row 5 | Position 2 |
| AP19194               | Panel W2        | Row 2 | Position 1 |
| AP19233               | Panel U2        | Row 5 | Position 1 |
| AP19239               | Panel U2        | Row 3 | Position 1 |
| AP19246               | Panel U2        | Row 5 | Position 2 |
| AP19270               | Panel T2        | Row 5 | Position 1 |
| AP19274               | Panel U2        | Row 4 | Position 1 |
| AP19376               | Panel V2        | Row 5 | Position 2 |
| AP19378               | Panel Y2        | Row 2 | Position 2 |
| AP19386               | Panel T2        | Row 3 | Position 4 |
| AP19422               | Panel V1        | Row 1 | Position 3 |
| AP19440               | Panel Z2        | Row 5 | Position 3 |
| AP19453               | Panel U2        | Row 4 | Position 4 |
| AP19613               | Panel V1        | Row 8 | Position 4 |
| AP19614               | Panel W2        | Row 3 | Position 2 |
| AP19615               | Panel U2        | Row 8 | Position 3 |
| AP19626               | Panel Y2        | Row 1 | Position 2 |
| AP19639               | Panel U2        | Row 6 | Position 2 |

| <b>Auveco Pak No.</b> | <b>Location</b> |       |            |
|-----------------------|-----------------|-------|------------|
| AP19655               | Panel U1        | Row 4 | Position 1 |
| AP19682               | Panel T2        | Row 8 | Position 3 |
| AP19721               | Panel W2        | Row 2 | Position 4 |
| AP19729               | Panel U1        | Row 1 | Position 3 |
| AP19739               | Panel V1        | Row 7 | Position 2 |
| AP19756               | Panel W2        | Row 2 | Position 2 |
| AP19757               | Panel Y2        | Row 4 | Position 4 |
| AP19777               | Panel Y1        | Row 3 | Position 4 |
| AP19800               | Panel Y2        | Row 4 | Position 3 |
| AP19801               | Panel U2        | Row 6 | Position 1 |
| AP19807               | Panel Y2        | Row 2 | Position 1 |
| AP19821               | Panel Y2        | Row 6 | Position 2 |
| AP19822               | Panel Y2        | Row 6 | Position 1 |
| AP19837               | Panel T1        | Row 4 | Position 2 |
| AP20192               | Panel T1        | Row 2 | Position 1 |
| AP20247               | Panel U2        | Row 4 | Position 2 |
| AP20248               | Panel U1        | Row 8 | Position 2 |
| AP20259               | Panel X1        | Row 6 | Position 1 |
| AP20316               | Panel T1        | Row 6 | Position 3 |
| AP20327               | Panel U2        | Row 5 | Position 3 |
| AP20328               | Panel Y2        | Row 5 | Position 3 |
| AP20335               | Panel U2        | Row 2 | Position 1 |
| AP20348               | Panel V1        | Row 5 | Position 3 |
| AP20349               | Panel U2        | Row 2 | Position 4 |
| AP20362               | Panel T1        | Row 7 | Position 1 |
| AP20366               | Panel T1        | Row 6 | Position 2 |
| AP20377               | Panel Y2        | Row 5 | Position 4 |
| AP20380               | Panel Z2        | Row 4 | Position 4 |
| AP20390               | Panel Y2        | Row 3 | Position 2 |
| AP20391               | Panel Y2        | Row 3 | Position 3 |
| AP20397               | Panel Z2        | Row 5 | Position 4 |
| AP20440               | Panel W2        | Row 2 | Position 3 |
| AP20455               | Panel X1        | Row 6 | Position 2 |
| AP20458               | Panel U2        | Row 8 | Position 2 |
| AP20543               | Panel U1        | Row 1 | Position 4 |
| AP20564               | Panel U2        | Row 5 | Position 4 |
| AP20607               | Panel Y2        | Row 5 | Position 1 |
| AP20627               | Panel V2        | Row 3 | Position 3 |
| AP20629               | Panel V2        | Row 5 | Position 1 |
| AP20632               | Panel V1        | Row 1 | Position 2 |
| AP20687               | Panel Y2        | Row 3 | Position 1 |
| AP20688               | Panel Y2        | Row 3 | Position 4 |
| AP20741               | Panel V2        | Row 6 | Position 2 |
| AP20757               | Panel Z1        | Row 7 | Position 4 |
| AP20758               | Panel Z1        | Row 6 | Position 4 |
| AP20774               | Panel Y2        | Row 5 | Position 2 |
| AP20788               | Panel V2        | Row 3 | Position 2 |
| AP20834               | Panel V2        | Row 3 | Position 4 |
| AP20869               | Panel U2        | Row 2 | Position 2 |
| AP20888               | Panel U2        | Row 6 | Position 4 |
| AP20889               | Panel U2        | Row 8 | Position 4 |
| AP20908               | Panel U2        | Row 2 | Position 3 |
| AP20931               | Panel U2        | Row 8 | Position 1 |
| AP20954               | Panel W2        | Row 1 | Position 4 |
| AP20955               | Panel U2        | Row 3 | Position 3 |
| AP20986               | Panel U2        | Row 4 | Position 3 |

**A great introduction to prospective accounts or  
an exciting new program to increase sales with existing customers**

**Free Cabinet**  
when you buy  
4 different assortments

**The Most Popular**  
Body Hardware &  
Specialty Fasteners



The Body Hardware Master Program, 6600BHM is based on Auveco's **DB-428 Display Boards**.

We have developed 20 large metal drawer assortments, which contain 428 of the most popular domestic and foreign body hardware clips and fasteners. Items come in heavy gauge steel, pre-labeled and pre-loaded large drawers and cabinets.

Each drawer is set up to accommodate the Auveco unit package quantity. No more problems with refills.

**6650BHM:** Buy a combination of any four different 6600BHM series individual drawer assortments and you'll receive one FREE 2-96 four drawer cabinet

## Assortments Based on DB-428 Display Boards

*Photos not actual size*



**6601BHM**  
Small Retainers &  
Retaining Clips  
24 Varieties, 840 Pieces

Contains the following  
Auveco part numbers:

**10621, 11612, 11796, 12565,  
12737, 12992, 13470, 14021, 14291,  
14328, 14736, 14737, 15367, 15970,  
17339, 18033, 18114, 18297, 18848,  
18877, 19114, 19682, 19729 & 20543**



**6603BHM**  
Hood Insulation Retainers,  
Trim Panel Fasteners &  
Rubber Vacuum Caps  
16 Varieties, 440 Pieces

Contains the following  
Auveco part numbers:

**4439, 4440, 11863, 11130, 12134, 12209,  
12210, 12907, 12908, 14163, 15456,  
19613, 19614, 19655, 20757 & 20758**



**6602BHM**  
Large Retainers  
22 Varieties, 965 Pieces

Contains the following  
Auveco part numbers:

**10831, 12137, 12571, 12731, 12759,  
12766, 12909, 14036, 14738, 15414,  
15479, 15543, 15998, 16818, 17004,  
17612, 17664, 17975, 19837, 20192,  
20362 & 20366**



**6604BHM**  
Push-Type Retainers  
24 Varieties, 445 Pieces

Contains the following  
Auveco part numbers:

**14260, 14753, 14992, 14997,  
16000, 16858, 17057, 17143,  
17144, 17267, 17379, 17472,  
17632, 18119, 18888, 19118,  
19239, 19739, 20335, 20348,  
20349, 20869, 20908 & 20955**

Based on DB-428 Display Boards • *Photos not actual size*



**6605BHM**

Push-Type Retainers  
24 Varieties, 492 Pieces

Contains the following  
Auveco part numbers:  
**12757, 13993, 13996, 14010,  
14019, 14020, 17216, 17222,  
18873, 19233, 19246, 19274,  
19422, 19453, 19615, 19639,  
19801, 20247, 20327,  
20564, 20632, 20889,  
20931 & 20986**



**6606BHM**

Push-Type Retainers,  
Nylon Rivets  
& Specialty Rivets  
24 Varieties, 680 Pieces

Contains the following  
Auveco part numbers:  
**12567, 12652, 13748, 13750,  
13751, 13753, 13755, 14011,  
14023, 14127, 16834, 16864,  
17006, 17121, 17410, 17615,  
17639, 18108, 18167, 18353,  
18461, 19376, 20629 & 20741**

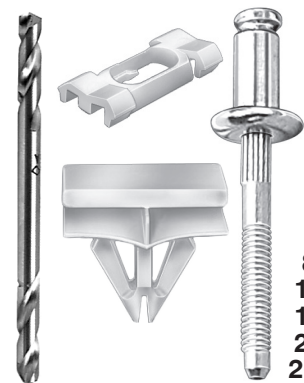

**6607BHM**

Specialty Rivets, Double End  
Drill & Moulding Clips  
24 Varieties, 925 Pieces

Contains the following  
Auveco part numbers:  
**8301, 8311, 8313, 8925,  
8931, 12653, 12655, 12658,  
12676, 14642, 16837, 16838,  
19757, 19821, 19822, 20328,  
20377, 20523, 20607, 20626,  
20627, 20774, 20788 & 20834**



**6608BHM**

Moulding Clips & Fasteners,  
Plug Buttons &  
Wire Loom Clips  
22 Varieties, 840 Pieces

Contains the following  
Auveco part numbers:  
**2619, 2744, 2752, 8941,  
9288, 9633, 9749, 9965,  
11746, 14545, 14546,  
14547, 19378, 19626, 19807,  
20390, 20391, 20392, 20397,  
20429, 20687 & 20688**



**6609BHM**

Phillips Oval Head, Phillips Pan  
Head & Specialty Tapping Screws  
(Chrome & Zinc)  
24 Varieties, 2400 Pieces



Contains the following  
Auveco part numbers:  
**1423, 1483, 1717, 1794, 1796, 1799, 1940, 1943,  
2027, 2365, 2366, 2367, 2710, 2713, 2728, 2730,  
2731, 3079, 3090, 9603, 9605, 12095, 15172 & 19777**



**6610BHM**

Phillips Oval Head Sems® (Chrome  
& Black Phosphate) & Hex Washer  
Head (Zinc and Zinc & Yellow)  
Tapping Screws  
24 Varieties, 1825 Pieces



Contains the following  
Auveco part numbers:  
**2751, 2772, 2773, 2775, 3466, 3467, 9611, 9615,  
11369, 11450, 11451, 11455, 11456, 11788, 11789,  
11790, 11791, 11792, 11914, 15170, 16828,  
16960, 17098 & 17980**



**6611BHM**

Phillips Oval Head (Black Oxide),  
Phillips Pan Head (Black Oxide) &  
Specialty Tapping Screws  
(Black E-Coat)  
24 Varieties, 2175 Pieces

Contains the following Auveco part numbers:  
**10162, 10164, 10165, 10166, 10167, 10168, 10180,  
10181, 10182, 11086, 11087, 11088, 11089, 11917,  
11921, 11922, 11923, 12796, 12797, 12799,  
12820, 12957, 16323 & 20259**

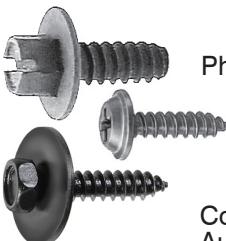

**6612BHM**

Phillips Flat Top Washer Head (Black),  
Hex Head Sems® (Black) &  
Hex Slotted Head (Black)  
Tapping Screws  
23 Varieties, 1750 Pieces

Contains the following  
Auveco part numbers:  
**12060, 12213, 12214, 12215, 12216, 12217, 12218,  
12339, 12351, 12738, 12742, 12953, 12954, 13026,  
15373, 15774, 15775, 16421, 17459, 17650,  
18340, 18354 & 20455**



**6613BHM**

Hex Head Sems & Hex Washer  
Head Body Bolts (Black)  
21 Varieties, 810 Pieces



Contains the following  
Auveco part numbers:  
**9480, 10362, 10823, 11109,  
11110, 11320, 11641, 12065,  
12066, 12160, 12232, 12324, 12336,  
12343, 12693, 13613, 13614, 13618,  
13619, 18416 & 18769**

# BODY HARDWARE MASTER ASSORTMENTS

Based on DB-428 Display Boards • *Photos not actual size*

**Sec. 15**



## 6614BHM

Hex Head Sems® & Hex Washer Head Body Bolts (Zinc), Bumper Bolts & Specialty Fasteners  
12 Varieties, 445 Pieces

Contains the following Auveco part numbers:  
4474, 5242, 5246, 8443, 11295, 12335, 14473, 14976, 16826, 17316, 18262 & 19339



## 6615BHM

Spin Lock Nuts, Hex Flange Nuts, Free Spinning Washer Nuts, Jack Nuts & Well Nuts  
23 Varieties, 705 Pieces

Contains the following Auveco part numbers:  
11644, 11645, 12595, 12596, 12995, 12999, 13004, 13007, 13008, 13009, 13010, 13014, 13016, 14855, 15326, 15329, 15334, 15335, 16470, 16769, 16830, 16883 & 20415

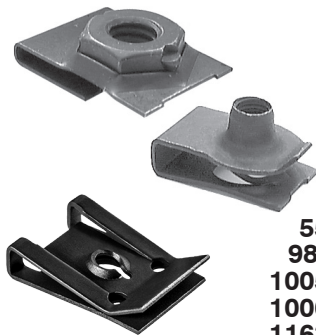

## 6616BHM

J-Nuts, Spring Type U-Nuts & Extruded U-Nuts  
23 Varieties, 965 Pieces

Contains the following Auveco part numbers:  
5586, 5589, 8359, 8814, 9879, 9880, 10051, 10053, 10054, 10055, 10064, 10065, 10066, 10067, 11628, 11629, 11630, 11631, 12575, 12669, 14750, 15677 & 15752



## 6617BHM

Flat Nuts, U-Nuts, Tubular Nuts & Shims  
11 Varieties, 950 Pieces

Contains the following Auveco part numbers:  
1903, 2089, 2099, 2293, 2595, 3155, 3156, 5076, 5077, 5196 & 11292

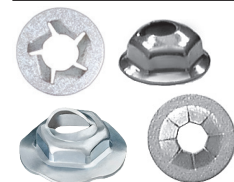

## 6618BHM

Washer Lock Nuts, Thread Cutting Nuts, Push-On Retainers & Pushnut Bolt Retainers  
23 Varieties, 2300 Pieces

Contains the following Auveco part numbers:  
2555, 2557, 2896, 2897, 3404, 3405, 8863, 8864, 8865, 8868, 8869, 9297, 9299, 10086, 10087, 10374, 10733, 12123, 12127, 12253, 12255, 12259 & 14980



## 6619BHM

Nylon Nuts & Screw Grommets  
23 Varieties, 860 Pieces

Contains the following Auveco part numbers:  
3682, 8435, 9829, 9862, 11368, 11691, 11719, 13450, 13932, 13933, 13960, 14031, 14267, 14268, 14274, 14275, 14695, 18153, 19194, 19721, 19756, 20440 & 20954



## 6620BHM

Door Hinge Pins & Bushings, Headlight Hardware, Door Lock Rod Clips, Window Crank Handle Retainer Clips & Cable Straps  
14 Varieties, 336 Pieces

Contains the following Auveco part numbers:  
2288, 3178, 11243, 14298, 14550, 14553, 14559, 15518, 15940, 16936, 16937, 19424, 19781 & 20380

**6649BHM**  
Small Size • Grade 5 USS • Cap Screws, Nuts & Washers  
12 Varieties, 150 Pieces

| Auveco Part No. | Size              |
|-----------------|-------------------|
| 5434*           | 1/4"-20 x 1/2"    |
| 5436*           | 1/4"-20 x 3/4"    |
| 5438*           | 1/4"-20 x 1"      |
| 5449*           | 5/16"-18 x 3/4"   |
| 5451*           | 5/16"-18 x 1"     |
| 5452*           | 5/16"-18 x 1-1/4" |
| 5453            | 5/16"-18 x 1-1/2" |
| 5455            | 5/16"-18 x 2"     |
| 15586           | 1/4"-20 Hex Nut   |
| 15587           | 5/16"-18 Hex Nut  |
| 8606            | 1/4" USS Washer   |
| 8607            | 5/16" USS Washer  |

\*Threaded to the head

**6634BHM**  
Large Size • Metric Cap Screws, Nuts & Washers  
12 Varieties, 380 Pieces

| Auveco Part No. | Size             |
|-----------------|------------------|
| 14430           | M10-1.5 x 20mm   |
| 14431           | M10-1.5 x 25mm   |
| 14432           | M10-1.5 x 30mm   |
| 14433           | M10-1.5 x 35mm   |
| 14434           | M10-1.5 x 40mm   |
| 14436           | M10-1.5 x 50mm   |
| 14438           | M10-1.5 x 60mm   |
| 14439           | M10-1.5 x 70mm   |
| 14441           | M12-1.75 x 30mm  |
| 14442           | M12-1.75 x 35mm  |
| 14443           | M12-1.75 x 40mm  |
| 14445           | M12-1.75 x 50mm  |
| 14454           | M10-1.5 Hex Nut  |
| 14455           | M12-1.75 Hex Nut |
| 17395           | 10mm Flat Washer |
| 10583           | 12mm Flat Washer |

Based on DB-428 Display Boards • *Photos not actual size*

**6642BHM**

Large Size • Grade 5 USS • Cap Screws, Nuts & Washers  
8 Varieties, 650 Pieces



| Auveco Part No. | Size             |
|-----------------|------------------|
| 5463            | 3/8"-16 x 3/4    |
| 5465            | 3/8"-16 x 1"     |
| 5466            | 3/8"-16 x 1-1/4" |
| 5467            | 3/8"-16 x 1-1/2" |
| 5469            | 3/8"-16 x 2"     |
| 5471            | 3/8"-16 x 2-1/2" |
| 5476            | 7/16"-14 x 1"    |
| 5477            | 7/16"-14 x 1-1/4 |
| 15588           | 3/8"-16 Hex Nut  |
| 15589           | 7/16"-14 Hex Nut |
| 8608            | 3/8" USS Washer  |
| 8609            | 7/16" USS Washer |

**6629BHM**

J.I.S. Hex Flange Bolts & Spin Lock Nuts  
21 Varieties, 550 Pieces



| Auveco Part No. | Size            |
|-----------------|-----------------|
| 17315           | M6-1.0 x 12mm   |
| 17316           | M6-1.0 x 16mm   |
| 18807           | M6-1.0 x 20mm   |
| 21048           | M6-1.0 x 25mm   |
| 18808           | M6-1.0 x 30mm   |
| 18809           | M6-1.0 x 40mm   |
| 18980           | M8-1.25 x 12mm  |
| 17387           | M8-1.25 x 16mm  |
| 17388           | M8-1.25 x 20mm  |
| 21051           | M8-1.25 x 25mm  |
| 17389           | M8-1.25 x 30mm  |
| 21052           | M8-1.25 x 35mm  |
| 17390           | M8-1.25 x 40mm  |
| 21053           | M8-1.25 x 45mm  |
| 17188           | M10-1.25 x 16mm |
| 17189           | M10-1.25 x 20mm |
| 21054           | M10-1.25 x 25mm |
| 17190           | M10-1.25 x 30mm |
| 21055           | M10-1.25 x 35mm |
| 17191           | M10-1.25 x 40mm |
| 21056           | M10-1.25 x 45mm |
| 16769           | M6-1.0 Nut      |
| 16830           | M8-1.25 Nut     |
| 16470           | M10-1.25 Nut    |

**6635BHM**

Small Size • Metric Cap Screws, Nuts & Washers  
14 Varieties, 925 Pieces



| Auveco Part No. | Size            |
|-----------------|-----------------|
| 14403           | M5-.8 x 16mm    |
| 14404           | M5-.8 x 20mm    |
| 14407           | M6-1.0 x 12mm   |
| 14408           | M6-1.0 x 16mm   |
| 14409           | M6-1.0 x 20mm   |
| 14410           | M6-1.0 x 25mm   |
| 14411           | M6-1.0 x 30mm   |
| 14419           | M8-1.25 x 16mm  |
| 14420           | M8-1.25 x 20mm  |
| 14421           | M8-1.25 x 25mm  |
| 14422           | M8-1.25 x 30mm  |
| 14423           | M8-1.25 x 35mm  |
| 14424           | M8-1.25 x 40mm  |
| 14426           | M8-1.25 x 50mm  |
| 14449           | M5-.8 Hex Nut   |
| 14450           | M6-1.0 Hex Nut  |
| 14452           | M8-1.25 Hex Nut |
| 10578           | 5mm Flat Washer |
| 17393           | 6mm Flat Washer |
| 17394           | 8mm Flat Washer |

**6630BHM**

Nylon Connectors & Rubber Vacuum Caps  
24 Varieties, 310 Pieces



| Auveco Part No.         | Size                  |          |
|-------------------------|-----------------------|----------|
| <b>Nylon Connectors</b> |                       |          |
| 12929                   | 1/8" x 1/8"           | Straight |
| 12930                   | 1/8" x 3/16"          | Straight |
| 12936                   | 1/8" x 1/4"           | Straight |
| 12937                   | 3/16" x 3/16"         | Straight |
| 12935                   | 1/4" x 3/16"          | Straight |
| 12931                   | 1/4" x 1/4"           | Straight |
| 12946                   | 5/16" x 5/16"         | Straight |
| 12923                   | 1/8" x 1/8" x 1/8"    | Tee      |
| 12926                   | 3/16" x 3/16" x 1/8"  | Tee      |
| 12918                   | 3/16" x 3/16" x 3/16" | Tee      |
| 12919                   | 1/4" x 3/16" x 3/16"  | Tee      |
| 11738                   | 1/4" x 1/4" x 3/16"   | Tee      |
| 17629                   | 1/4" x 1/4" x 1/4"    | Tee      |
| 12920                   | 5/16" x 5/16" x 5/16" | Tee      |
| 12927                   | 3/16" x 3/16" x 3/16" | Y        |
| 12943                   | 1/4" x 1/4" x 1/4"    | Y        |
| 12932                   | 3/16" x 3/16"         | Elbow    |
| 12939                   | 3/16"                 | Cross    |

**Rubber Caps**

|       |                      |
|-------|----------------------|
| 12209 | For 1/8" O. D. Tube  |
| 4440  | For 3/16" O. D. Tube |
| 4439  | For 1/4" O. D. Tube  |
| 12907 | For 5/16" O. D. Tube |
| 12210 | For 3/8" O. D. Tube  |
| 12908 | For 1/2" O. D. Tube  |

**6631BHM**

Krimp and Seal Terminals & Connectors  
24 Varieties, 240 Pieces



| Auveco Part No. | Description             |
|-----------------|-------------------------|
| 13656           | Ring Type, 22-18 Ga.    |
| 13657           | Ring Type, 22-18 Ga.    |
| 13658           | Spade Type, 22-18 Ga.   |
| 13659           | Butt Conn., 22-18 Ga.   |
| 13660           | Female Q. C., 22-18 Ga. |
| 13661           | Male Q. C., 22-18 Ga.   |
| 13662           | Ring Type, 16-14 Ga.    |
| 13663           | Ring Type, 16-14 Ga.    |
| 13664           | Ring Type, 16-14 Ga.    |
| 13665           | Ring Type, 16-14 Ga.    |
| 13666           | Ring Type, 16-14 Ga.    |
| 13669           | Butt Conn., 16-14 Ga.   |
| 13670           | Female Q. C., 16-14 Ga. |
| 13671           | Male Q. C., 16-14 Ga.   |
| 13672           | Female Q. C., 16-14 Ga. |
| 13673           | Male Q. C., 16-14 Ga.   |
| 13681           | Female Plug, 16-14 Ga.  |
| 13682           | Male Plug, 16-14 Ga.    |
| 13674           | Ring Type, 12-10 Ga.    |
| 13675           | Ring Type, 12-10 Ga.    |
| 13676           | Ring Type, 12-10 Ga.    |
| 13678           | Butt Conn., 12-10 Ga.   |
| 13679           | Female Q. C., 12-10 Ga. |
| 13680           | Male Q. C., 12-10 Ga.   |

**6699BHM**

High Performance Imported  
Miniature & Halogen Bulbs  
71 Varieties, 494 Pieces



Contains Auveco Assortments  
**6643BHM, 6644BHM,**  
**6645BHM,**  
**1-924 24 Compartment Empty**  
**Drawer and 2-96**  
**Four Drawer Cabinet.**



## 6643BHM

High Performance  
Imported Miniature Bulbs  
24 Varieties, 240 Pieces

Contain the following  
Auveco Part Numbers:  
**B24, B24A, B53, B57, B67,  
B67A, B68, B89, B97, B168,  
B194, B194A, B906, B906A,  
B912, B916, B916A, B921,  
B921A, B1141, B1156,  
B1156A, B1157 & B1157A**



## 6644BHM

High Performance  
Imported Miniature Bulbs  
23 Varieties, 230 Pieces

Contain the following  
Auveco Part Numbers:  
**B1893, B1895, B2057,  
B2057A, B2357, B2357A,  
B3057, B3057A, B3156,  
B3156A, B3157, B3157A,  
B3357, B3357A, B3457,  
B3457A, B4114K, B4157,  
B4157K, B7440, B7440A,  
B7443 & B7443A**



## 6645BHM

High Performance  
Imported Halogen Bulbs  
24 Varieties, 24 Pieces

Contain the following  
Auveco Part Numbers:  
**B880, B881, B884, B885,  
B886, B889, B890, B891,  
B893, B894, B896, B899,  
B9004, B9005, B9006,  
B9007, BH1, BH3, BH7, BH9,  
BH10, BH11, BH13 & BD2C**



## 6641BHM

Cable Ties & Straps  
10 Varieties, 575 Pieces

| Auveco Part No. | Description             |
|-----------------|-------------------------|
| <b>8550</b>     | 2-1/4" Long, 7/16" Wide |
| <b>14298</b>    | 140mm Long, 8mm Wide    |
| <b>15144</b>    | 4" Long, 3/32" Wide     |
| <b>15145</b>    | 5-1/2" Long, 1/8" Wide  |
| <b>15146</b>    | 7" Long, 3/16" Wide     |
| <b>15147</b>    | 11" Long, 3/16" Wide    |
| <b>15148</b>    | 14" Long, 5/16" Wide    |
| <b>15753</b>    | 14" Long, 3/16" Wide    |
| <b>20380</b>    | 200mm Long, 5mm Wide    |
| <b>21203</b>    | 155mm Long, 5mm Wide    |

## 6628BHM

Oil Drain Plugs & Gaskets  
24 Varieties, 105 Pieces



| Auveco Part No. | Size |
|-----------------|------|
|-----------------|------|

|              |                         |
|--------------|-------------------------|
| <b>14196</b> | 1/2"-20                 |
| <b>18373</b> | 1/2"-20                 |
| <b>19130</b> | 1/2"-20                 |
| <b>19365</b> | 1/2"-20, Magnetic       |
| <b>15527</b> | M12-1.25                |
| <b>19588</b> | M12-1.25                |
| <b>14677</b> | M12-1.75                |
| <b>18023</b> | M12-1.75                |
| <b>18374</b> | M12-1.75                |
| <b>20347</b> | M12-1.75                |
| <b>21047</b> | M12-1.75                |
| <b>18024</b> | M14-1.25                |
| <b>14678</b> | M14-1.5                 |
| <b>16308</b> | M14-1.5                 |
| <b>18025</b> | M14-1.5                 |
| <b>18375</b> | M14-1.5                 |
| <b>19141</b> | M14-1.5                 |
| <b>19279</b> | M14-1.5                 |
| <b>19620</b> | M14-1.5 Single Oversize |
| <b>19773</b> | M14-1.5                 |
| <b>20426</b> | M14-1.5                 |
| <b>15528</b> | M16.4-1.33              |
| <b>15529</b> | M18-1.5                 |
| <b>15530</b> | M20-1.5                 |

## 6637BHM

Nylon Rivets  
16 Varieties, 475 Pieces



| Auveco Part No. | Size   | Grip          |
|-----------------|--------|---------------|
| <b>20754</b>    | 6mm    | 2.5mm-4.8mm   |
| <b>13746</b>    | 3/16"  | 1/16"-9/64"   |
| <b>13747</b>    | 13/64" | 1/16"-11/64"  |
| <b>13748</b>    | 13/64" | 1/8"-15/64"   |
| <b>13755</b>    | 13/64" | 15/64"-25/64" |
| <b>14004</b>    | 15/64" | 11/64"-11/32" |
| <b>13752</b>    | 17/64" | 3/32"-3/16"   |
| <b>13753</b>    | 17/64" | 3/32"-3/16"   |
| <b>18502</b>    | 1/4"   | 5/32"-1/4"    |
| <b>13750</b>    | 1/4"   | 5/32"-13/32"  |
| <b>17101</b>    | 1/4"   | 5/16"-15/32"  |
| <b>18108</b>    | 1/4"   | 5/32"-3/8"    |
| <b>21028</b>    | 1/4"   | 5/32"-3/8"    |
| <b>13751</b>    | 1/4"   | 5/32"-13/32"  |
| <b>15490</b>    | 9/32"  | 3/32"-15/64"  |
| <b>14023</b>    | 15/64" | 5/32"-5/16"   |



**6633BHM**

Metal Specialty Rivets  
24 Varieties - 850 Pieces



| Auveco Part No.               | Size                  |
|-------------------------------|-----------------------|
| <b>1/8" (3.2mm) Diameter</b>  |                       |
| 20788                         | Grip: 3/64" - 1/8"    |
| 20627                         | Grip: 3/64" - 3/16"   |
| 16834                         | Grip: 1/8" - 3/16"    |
| 8931                          | Grip: 3/16" - 1/4"    |
| 17615                         | Grip: 3/16" - 3/8"    |
| <b>5/32" (4mm) Diameter</b>   |                       |
| 18461                         | Grip: 3/64" - 1/4"    |
| 20629                         | Grip: 3/64" - 1/4"    |
| 20971                         | Grip: 3/64" - 9/32"   |
| 19376                         | Grip: 1/8" - 11/32"   |
| 17006                         | Grip: 1/4" - 3/8"     |
| <b>3/16" (4.8mm) Diameter</b> |                       |
| 16864                         | Grip: 3/64" - 11/32"  |
| 20741                         | Grip: 3/64" - 23/64"  |
| 17121                         | Grip: 5/64" - 15/64"  |
| 8311                          | Grip: 1/8" - 1/4"     |
| 17410                         | Grip: 3/8" - 1/2"     |
| 14127                         | Grip: 3/8" - 1/2"     |
| <b>1/4" (6.4mm) Diameter</b>  |                       |
| 16837                         | Grip: 1/32" - 9/64"   |
| 12653                         | Grip: 3/32" - 1/8"    |
| 18167                         | Grip: 3/32" - 9/64"   |
| 12652                         | Grip: 1/8" - 1/4"     |
| 12655                         | Grip: 9/64" - 3/16"   |
| 17639                         | Grip: 3/16" - 3/8"    |
| 8313                          | Grip: 1/4" - 3/8"     |
| 16838                         | Grip: 33/64" - 19/32" |

**6632BHM**

GM, Ford & Chrysler  
Push-Type Retainers  
12 Varieties - 400 Pieces



Contains the following  
Auveco part numbers:  
**17216, 20889, 20888, 20991,  
20826, 20992, 20880, 20988,  
20989, 20990, 20993 & 20994**

**6622BHM**

BMW Clips & Fasteners  
14 Varieties - 565 Pieces



| Auveco Part No. | Description                    |
|-----------------|--------------------------------|
| 13158           | Moulding Clip                  |
| 13162           | U-Nut                          |
| 13215           | U-Nut                          |
| 13216           | U-Nut                          |
| 13218           | U-Nut                          |
| 13223           | U-Nut                          |
| 18156           | M4.8-1.59 x 16mm<br>L.P. Screw |
| 20186           | Grommet                        |
| 20234           | Push-Type Retainer             |
| 20248           | Push-Type Retainer             |
| 20253           | Trim Panel Retainer            |
| 20270           | Push-Type Retainer             |
| 20734           | Push-Type Retainer             |
| 20754           | Nylon Rivet                    |

**6624BHM**

Honda & Acura  
Push-Type Retainers  
24 Varieties - 360 Pieces



Contains the following  
Auveco part numbers:  
**14696, 14697, 16000, 16782,  
17057, 17143, 17144, 17267,  
17379, 18119, 19118, 19140,  
19231, 19233, 19239, 19416,  
19453, 20247, 20352, 20564,  
20608, 20986, 21173 & 21297**

**6638BHM**

GM Moulding Clips  
24 Varieties - 415 Pieces



Contains the following  
Auveco part numbers:  
**10617, 14642, 19757, 19800,  
19820, 19821, 19822, 20280,  
20318, 20328, 20353, 20377,  
20607, 20756, 20774, 20808,  
20865, 20884, 20934, 20952,  
20972, 20976, 21128 &  
21374**

**6623BHM**

Honda & Acura  
Retainers & Retaining Clips  
24 Varieties - 595 Pieces



Contains the following  
Auveco part numbers:  
**14289, 14291, 14328, 15998, 16775,  
16776, 16779, 17205, 18114, 18294,  
18746, 18877, 19114, 19116, 19145,  
19171, 19470, 19506, 19682, 20334,  
20609, 20610, 20882 & 21107**

**6639BHM**

Hyundai & Kia  
Clips & Fasteners  
20 Varieties - 455 Pieces



| Auveco Part No. | Description              |
|-----------------|--------------------------|
| 20543           | Hood Ins. Retainer       |
| 20566           | Moulding Clip            |
| 20567           | Moulding Clip            |
| 20568           | Moulding Clip            |
| 20680           | L. P. Screw              |
| 21064           | Moulding Clip            |
| 21067           | Bumper & Grille Retainer |
| 21068           | Nylon Nut                |
| 21070           | Trim Panel Retainer      |
| 21136           | Moulding Clip            |
| 21146           | Push-Type Retainer       |
| 21188           | Trim Panel Retainer      |
| 21244           | Moulding Clip            |
| 21312           | Moulding Clip            |
| 21321           | Moulding Clip            |
| 21328           | Push-Type Retainer       |
| 21360           | Trim Panel Retainer      |
| 21378           | Nylon U-Nut              |
| 21381           | Hood Seal Retainer       |
| 21382           | Cowl & Grille Retainer   |

## 6621BHM

Mercedes-Benz  
Clips & Fasteners  
24 Varieties - 665 Pieces



| Auveco Part No. | Description          |
|-----------------|----------------------|
| 13215           | U-Nut                |
| 13216           | U-Nut                |
| 13218           | U-Nut                |
| 13220           | U-Nut                |
| 13223           | U-Nut                |
| 13224           | U-Nut                |
| 13230           | Push-Type Retainer   |
| 16124           | Tubular Type Nut     |
| 20187           | Push-Type Retainer   |
| 20188           | Trim Panel Retainer  |
| 20203           | Push-Type Retainer   |
| 20205           | Moulding Insert      |
| 20314           | Push-Type Retainer   |
| 20636           | Push-Type Retainer   |
| 20637           | Push-Type Retainer   |
| 20638           | Push-Type Retainer   |
| 20642           | Door Panel Ret. Clip |
| 20645           | Carpet Retainer      |
| 20650           | U-Nut                |
| 20735           | Door Panel Retainer  |
| 20897           | Moulding Clip        |
| 20909           | Push-Type Retainer   |
| 20971           | Rivet                |
| 21105           | Hood Ins. Retainer   |

## 6640BHM

Volkswagen & Audi  
Clips & Fasteners  
24 Varieties - 595 Pieces



| Auveco Part No. | Description              |
|-----------------|--------------------------|
| 13173           | Door Panel Clip          |
| 13475           | Trim Panel Retainer      |
| 17006           | Moulding Rivet           |
| 19195           | Push-Type Retainer       |
| 20341           | Trim Panel Retainer      |
| 20924           | Screw Grommet            |
| 20925           | Screw Grommet            |
| 21144           | Trim Panel Retainer      |
| 21145           | Hood Ins. Retainer       |
| 21251           | Push-Type Retainer       |
| 21392           | Cowl & Grille Retainer   |
| 21393           | Trim Retainer            |
| 21394           | Moulding Clip            |
| 21395           | Moulding Clip            |
| 21396           | Moulding Clip            |
| 21397           | Moulding Clip Grommet    |
| 21398           | Trim Panel Retainer      |
| 21399           | Screw Grommet            |
| 21449           | Moulding Clip            |
| 21478           | Moulding Clip            |
| 21479           | Push-Type Retainer       |
| 21512           | Moulding Clip            |
| 21513           | Push-On Retainer         |
| 21515           | Fender & Bumper Retainer |

## 6625BHM

Nissan & Infiniti  
Retainers & Push-Type Retainers  
24 Varieties - 525 Pieces



Contains the following  
Auveco part numbers:  
**14355, 14696, 14737, 16000,  
16776, 16782, 16784, 16858, 16859,  
17237, 17347, 17452, 17472, 18166, 18948,  
19246, 19274, 19684, 20327, 20348,  
20349, 20672, 20953 & 21192**

## 6646BHM

Subaru  
Clips & Fasteners  
24 Varieties - 450 Pieces



| Auveco Part No. | Description         |
|-----------------|---------------------|
| 21322           | Panel Retainer      |
| 21420           | Push-Type Retainer  |
| 21421           | Hood Ins. Retainer  |
| 21422           | Push-Type Retainer  |
| 21500           | Push-Type Retainer  |
| 21501           | Push-Type Retainer  |
| 21502           | Panel Retainer      |
| 21530           | Push-Type Retainer  |
| 21531           | Cowl Panel Vent Cap |
| 21563           | Push-Type Retainer  |
| 21566           | Push-Type Retainer  |
| 21570           | Push-Type Retainer  |
| 21571           | Push-Type Retainer  |
| 21572           | Grille Clip         |
| 21574           | Trim Retainer       |
| 21576           | Push-Type Retainer  |
| 21580           | Push-Type Retainer  |
| 21581           | Moulding Clip       |
| 21584           | Panel Retainer      |
| 21585           | Push-Type Retainer  |
| 21591           | Moulding Clip       |
| 21592           | Push-Type Retainer  |
| 21593           | Push-Type Retainer  |
| 21594           | Push-Type Retainer  |

## 6626BHM

Toyota & Lexus  
Retainers & Retaining Clips  
24 Varieties - 550 Pieces



Contains the following  
Auveco part numbers:  
**14269, 14736, 14737, 14738, 15709, 18297, 18692,  
18842, 18844, 18876, 18878, 19112, 19113, 19210,  
19257, 19729, 19749, 19842, 20437, 20443,  
20633, 20757, 20758 & 21102**

## 6627BHM

Toyota & Lexus  
Push-Type Retainers  
24 Varieties - 316 Pieces



Contains the following  
Auveco part numbers:  
**14260, 16784, 17162, 17439,  
18270, 18873, 18888, 19140,  
19416, 19552, 19739, 20335,  
20349, 20577, 20869, 20908,  
20931, 20955, 21010, 21011,  
21103, 21123, 21201 & 21294**

**6647BHM**

Mazda Clips & Fasteners  
24 Varieties - 560 Pieces



| Auveco Part No. | Description           |
|-----------------|-----------------------|
| 14260           | Push-Type Retainer    |
| 14274           | Nylon Nut             |
| 14313           | Nylon Nut             |
| 14367           | Trim Panel Retainer   |
| 14695           | Screw Grommet         |
| 14697           | Push-Type Retainer    |
| 16000           | Push-Type Retainer    |
| 16858           | Push-Type Retainer    |
| 17632           | Push-Type Retainer    |
| 18206           | Push-Type Retainer    |
| 18458           | Hood Insulation Clip  |
| 18692           | Weatherstrip Retainer |
| 18824           | Trim Panel Retainer   |
| 19315           | Push-Type Retainer    |
| 19481           | Weatherstrip Retainer |
| 19747           | Push-Type Retainer    |
| 20465           | Push-Type Retainer    |
| 20755           | Push-Type Retainer    |
| 20923           | Push-Type Retainer    |
| 20932           | Trim Panel Retainer   |
| 20983           | Trim Panel Retainer   |
| 21024           | Push-Type Retainer    |
| 21171           | Moulding Clip         |
| 21307           | Retaining Clip        |

**6648BHM**

Mitsubishi Clips & Fasteners  
24 Varieties - 520 Pieces



| Auveco Part No. | Description        |
|-----------------|--------------------|
| 13932           | Nylon Nut          |
| 14255           | Nylon Nut          |
| 14275           | Screw Grommet      |
| 14695           | Screw Grommet      |
| 17195           | Grille Clip        |
| 17351           | Push-Type Retainer |
| 17472           | Push-Type Retainer |
| 18951           | Push-Type Retainer |
| 19140           | Push-Type Retainer |
| 19239           | Push-Type Retainer |
| 19320           | Retainer           |
| 19323           | Retainer           |
| 19325           | Retainer           |
| 19334           | Retainer           |
| 19485           | Nylon Nut          |
| 20247           | Push-Type Retainer |
| 20556           | Tapping Screw      |
| 20557           | Tapping Screw      |
| 20565           | Grommet            |
| 20571           | Retainer           |
| 20580           | Push-Type Retainer |
| 21118           | Retainer           |
| 21140           | Push-Type Retainer |
| 21658           | Push-Type Retainer |

**SMALL EMPTY DRAWERS AND CABINETS**

Small cabinet and drawers with plastic inserts are made of sturdy heavy gauge steel. The kits are designed with scoop compartments and slide easily onto the cabinet slide. All items are available in unit packages. For refills, order by Auveco number on lid label.

**Empty Drawers**

(13-5/16" Wide x 9-1/4" Deep x 2" High)  
With Locking Latch:

- 2-608: 8 Compartment
- 2-612: 12 Compartment
- 2-616: 16 Compartment
- 2-620: 20 Compartment
- 2-621: 21 Compartment
- 2-624: 24 Compartment



**4-60**

**Empty Cabinet.** Holds 4 Small Drawers.  
15-1/4" Wide x 11-3/4" Deep x 11-1/4" High  
Finish: Light Green Enamel  
Drawer Size: 13-5/16" Wide x 9-1/4" Deep x 2" High



**6-60**

**Cabinet & 6 Empty Small Drawers**  
24 Compartment Drawers with Locking Latches  
15-1/4" W x 11-3/4" D x 16-3/8" H  
Finish: Light Green Enamel  
Drawer Size: 13-5/16" Wide x 9-1/4" Deep x 2" High

**3-60**

**Empty Cabinet.** Holds 6 Small Drawers

# LARGE EMPTY DRAWERS AND CABINETS

*Photos not actual size*

**Sec. 15**

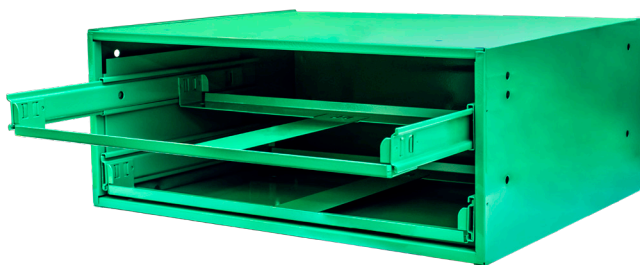

## 3-96

**Empty Cabinet.** Holds 2 Large Drawers.  
20" Wide x 15-3/4" Deep x 8" High  
Finish: Light Green Enamel  
Drawer Size: 18" Wide x 12" Deep x 3" High



## 4-96

**Cabinet & 4 Empty Large Drawers**  
24 Compartment Drawers with Locking Latches  
20" Wide x 15-3/4" Deep x 14-1/2" High  
Finish: Light Green Enamel  
Drawer Size: 18" Wide x 12" Deep x 3" High

## 2-96

**Empty Cabinet.** Holds 4 Large Drawers  
**Base B-3 for cabinets 3-96, 4-96 and 2-96 is pictured on page 352**



## 1-900

Steel with Locking Latch

18 x 12 x 3  
Adjustable  
Compartment  
Empty Drawer with  
3 Vertical &  
3 Horizontal  
Dividers

UNIT PACKAGE: 1

## Empty Drawers

(18" Wide x 12" Deep x 3" High)

With Locking Latches:

1-912: 12 Compartment

1-916: 16 Compartment

1-920: 20 Compartment

1-924: 24 Compartment

1-932: 32 Compartment



## Empty Plastic Tray Inserts

1-916INSERT: 16 Compartment for Drawer 1-916

1-920INSERT: 20 Compartment for Drawer 1-920

1-924INSERT: 24 Compartment for Drawer 1-924

UNIT PACKAGE: 1 case per insert

Only available in Master Case of 4 - Not sold separately.



## 1-901

Steel with Locking Latch

18 x 12 x 3  
Adjustable  
Compartment  
Empty Drawer  
with 9 dividers

UNIT PACKAGE: 1



## 1-901 DIVIDERS

2-15/16" x 4-5/16"  
Divider  
for 1-901 Drawer



## 1-902

Steel with Locking Latch

18 x 12 x 3  
Adjustable  
Compartment  
Empty Drawer with  
6 fixed horizontal  
compartments and  
12 movable  
dividers adjustable  
on 1" centers.

UNIT PACKAGE: 1

*Photos not actual size*

|   |  |  |  |  |  |
|---|--|--|--|--|--|
|  |  |  |  |  |  |
|   |  |  |  |  |  |
|   |  |  |  |  |  |
|   |  |  |  |  |  |
|   |  |  |  |  |  |

Printed lid labels in 12, 16, 20 and 24 compartment layouts (small and large drawer sizes). Same size and layout as Fix-Kit lid labels. Labels have a peel-away liner and self-adhesive backing for permanent adhesion.

**Large Drawer Lid Labels**

**1-900L**

Assortment of 1 each of 1-912L, 1-916L, 1-920L & 1-924L.

UNIT PACKAGE: 1 Set

**1-912L**

Large Drawer 12 Compartment Lid Label

UNIT PACKAGE: 5

**1-916L**

Large Drawer 16 Compartment Lid Label

UNIT PACKAGE: 5

**1-920L**

Large Drawer 20 Compartment Lid Label

UNIT PACKAGE: 5

**1-924L**

Large Drawer 24 Compartment Lid Label

UNIT PACKAGE: 5

**Small Drawer Lid Labels**

**2-600L**

Assortment of 1 each of 2-612L, 2-616L, 2-620L & 2-624L

UNIT PACKAGE: 1 Set

**2-612L**

Small Drawer 12 Compartment Lid Label

UNIT PACKAGE: 5

**2-616L**

Small Drawer 16 Compartment Lid Label

UNIT PACKAGE: 5

**2-620L**

Small Drawer 20 Compartment Lid Label

UNIT PACKAGE: 5

**2-624L**

Small Drawer 24 Compartment Lid Label

UNIT PACKAGE: 5



**1-MBC**

Miniature Bulb Cabinet

19" Wide x 4" Deep x 26-3/4" High  
 Ideal for the storage and organization of automotive miniature bulbs, fuses, etc. Features 4 durable plastic tilt-out trays with 28 adjustable dividers allowing for the creation of 4 to 32 compartments. Back-up storage shelves are located behind the hinged cover. Can be hung on wall using keyholes punched in the back. Constructed of prime cold rolled steel with gray powder coat finish.

*Can be shipped via UPS*



**1-HTWD**

Hose, Tubing and Wire Dispenser

19-9/16" Wide x 7-1/2" Deep x 11-15/16" High (front), 13-3/32" High (back)  
 Holds up to 6 reels of hose, tubing or wire. 1" diameter grommets in the front assure smooth, tangle free dispensing. Can be hung on wall using keyholes punched in the back. Constructed of prime cold rolled steel with gray powder coat finish.

*Can be shipped via UPS*

# RACKS

*Photos not actual size*



**1-WSR**  
Wire Spool Rack

26-1/8" Wide x 6" Deep x  
37-1/8" High  
Four sturdy steel rods  
provide secure and  
convenient storage for reels  
as large as 11" in diameter.  
Heavy duty steel with  
enamel finish.  
Does not include wire.  
Weight: 20 lbs.



*Can be shipped via UPS*



**2-WSR**  
Wire Spool Rack

26" Wide x 5-3/4" Deep x 18" High  
Two sturdy steel rods for storing and  
dispensing spools of wire.  
May be counter, wall or vehicle mounted.  
Shipping Weight 15 lbs.

*Can be shipped via UPS*



**1-TR**  
Threaded Rod Rack

24" Wide x 6-7/8" Deep x  
24-3/8" High  
Separates and protects threaded rods,  
in 18 separate compartments,  
2-1/8" (54.0mm) in diameter.  
Does not include threaded rod stock.  
Heavy duty steel with enamel finish  
Weight: 14 lbs.

*Can be shipped via UPS*

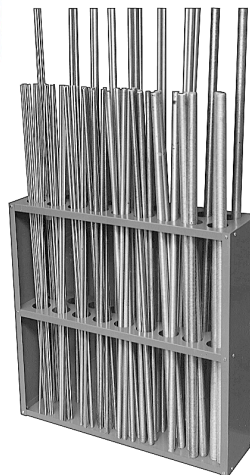

*Photos not actual size*

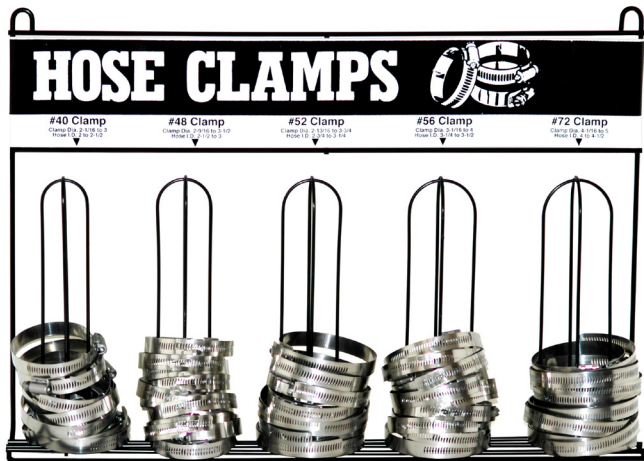

**5-HCR**

5 Loop Hose Clamp Rack

23-1/4" Wide x 5-3/8" Deep x 16-1/8" High  
 Holds 5 sizes of clamp diameters: #40 (2-1/16" to 3"),  
 #48 (2-9/16" to 3-1/2"), #52 (2-13/16" to 3-3/4"),  
 #56 (3-1/16" to 4") and #72 (4-1/16" - 5").  
 Can be set on counter top or hung on a wall using  
 the built-in hanger loops. Durable black powder coat  
 finish with black and white sign panel.

*Can be shipped via UPS*

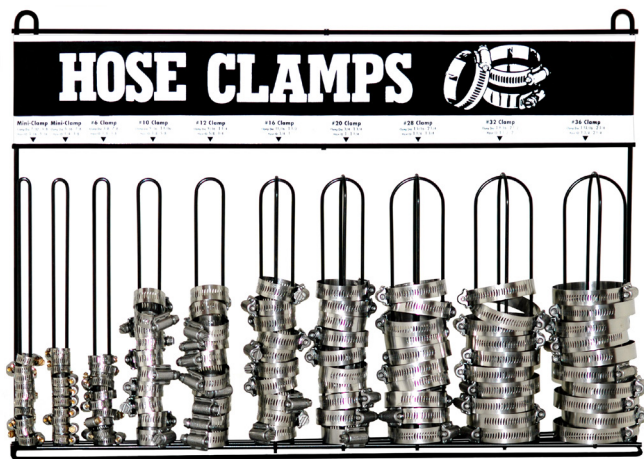

**10-HCR**

10 Loop Hose Clamp Rack

23-1/4" Wide x 5-3/8" Deep x 16-1/8" High  
 Holds 10 sizes of clamp diameters:  
 Mini-clamp (7/32" - 5/8"), Mini-clamp (5/16" - 7/8"),  
 #6 (3/8" to 7/8"), #10 (9/16" to 1-1/16"),  
 #12 (9/16" to 1-1/4"), #16 (11/16" to 1-1/2"),  
 #20 (3/4" to 1-3/4"), #28 (1-5/16" to 2-1/4"),  
 #32 (1-9/16" to 2-1/2") and #36 (1-13/16" to 2-3/4").  
 Can be set on counter top or hung on a wall using  
 the built-in hanger loops. Durable black powder coat  
 finish with black and white sign panel.

*Can be shipped via UPS*



**P277**

40 Compartment Bin

33-3/4" Wide x 12" Deep x 24" High  
 Color: green or gray enamel finish  
 Packing: 1 set up unit per carton  
 Shipping Weight: 47 lbs.

*Can be shipped via UPS*

**P40-S**

40 Compartment Bin

33-3/4" Wide x 9" Deep x 24" High  
 Color: green enamel finish  
 Packing: 1 set up unit per carton  
 Shipping Weight: 38 lbs.

*Can be shipped via UPS*

**72B-9**

72 Compartment Bin

33-3/4" Wide x 9" Deep x 42" High  
 Color: green enamel finish  
 Packing: 1 set up in two cartons  
 Shipping Weight: 75 lbs.  
 (Sold as a set only)

*Can be shipped via UPS*



**18-CB**

18 Compartment Bin  
 33-3/4" Wide x 12" Deep x 19-1/4" High  
 Shipping Weight: 38 lbs.

*Can be shipped via UPS*

**MB-36**  
Multi-Purpose Bin

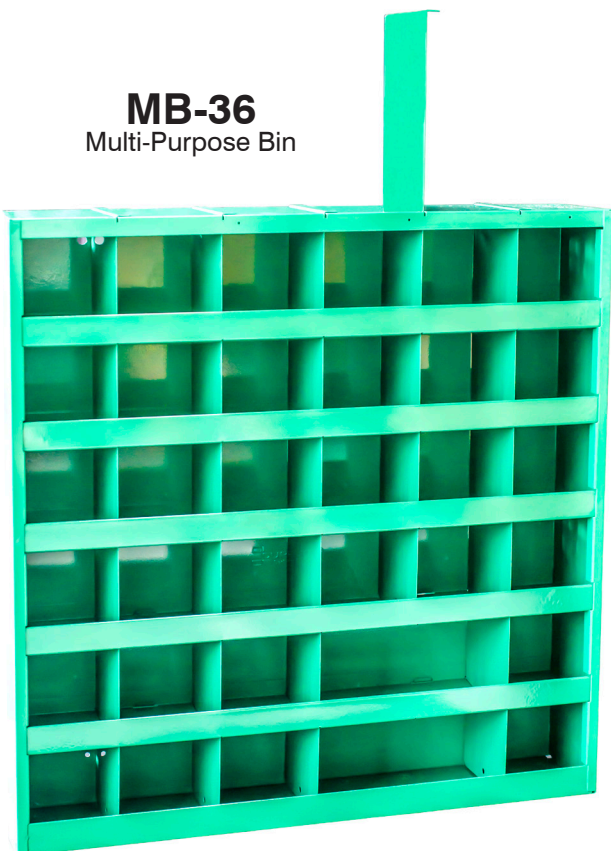

23-5/8" Wide x 4-3/4" Deep x 23-5/8" High.  
Removable vertical dividers allow the creation of double-width openings, each with scoops.  
Keyhole slots are provided for wall mounting.  
Shipping Weight: 25 lbs.

*Can be shipped via UPS*

## Bin Bases



### B-1

Base for Bins P277 & 18-D

Raises units 4 or 8 inches off the floor  
Color: green enamel finish

UNIT PACKAGE: 1

*Can be shipped via UPS*

### B-2

Base for Bin P40-S & 72B-9

Raises unit 4 or 8 inches off the floor  
Color: green enamel finish

UNIT PACKAGE: 1

*Can be shipped via UPS*



### 18-D

18 Drawer Cabinet (with 36 Dividers)

34" Wide x 11-1/4" Deep x 11" High  
Color: Green enamel finish  
Shipping Weight: 47 lbs.

*Can be shipped via UPS*



### 9-D

9 Drawer Cabinet  
(with 18 Dividers)

17-1/4" Wide x 11-5/8" Deep x 10-7/8" High  
Shipping Weight 28 lbs.

*Can be shipped via UPS*

## Dividers

For 18-D and 9-D

Plastic  
2-1/2" x 5-3/16"

UNIT PACKAGE: 1



### 1-ACC

Aerosol Can Caddy

21-1/2" Wide x 3-1/8" Deep x 5-1/4" High  
Holds 6 cans with a maximum can diameter of 3"  
Holes are provided for wall mounting.

Does not include cans.  
Shipping Weight: 2 lbs.

*Can be shipped via UPS*



*Photos not actual size*

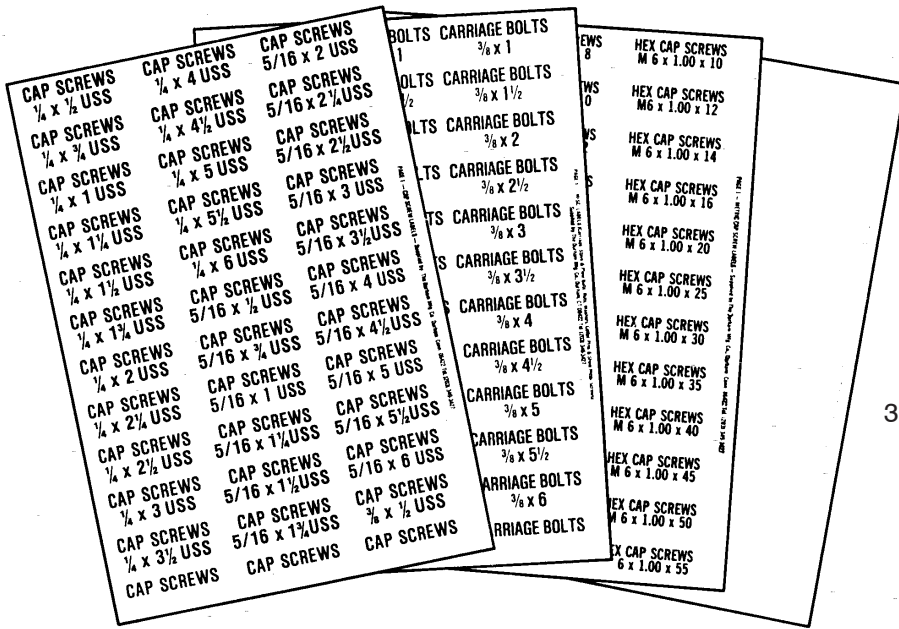

2" x 3/4" Pressure Sensitive  
Bin Labels Covering  
Popular Size U.S.S., S.A.E. and  
Metric Fasteners.  
36 Labels per each 6-1/4" x 9" page.

**15531**

U.S.S. Fastener Labels for Cap Screws, Nuts,  
Lock Washers, Flat Washers and Blanks

Diameters: 1/4", 5/16", 3/8", 7/16", 1/2",  
9/16", 5/8", 3/4", 7/8", & 1"  
Lengths: 1/2" thru 6"  
Total of 6 pages

UNIT PACKAGE: 1 Set

**15532**

S.A.E. Fastener Labels for Cap Screws, Nuts,  
Lock Washers, Flat Washers and Blanks

Diameters: 1/4", 5/16", 3/8", 7/16", 1/2",  
9/16", 5/8", 3/4", 7/8", & 1"  
Lengths: 1/2" thru 6"  
Total of 6 pages

UNIT PACKAGE: 1 Set

**15533**

Bin Labels Assortment  
Consists of 1 set each of 15531, 15532,  
14774 & 14775

UNIT PACKAGE: 1 Set

**14774**

Metric Fastener Labels for Hex Cap Screws  
(Regular & Fine Thread), Hex Nuts, Nylon Insert  
Lock Nuts, Split Lock Washers, Flat Washers, Wave  
Washers, Socket Cap Screws and Socket Set Screws

Diameters: 4mm, 5mm, 6mm, 7mm, 8mm, 10mm,  
12mm, 14mm, 16mm, 20mm & 24mm.  
Total of 9 pages

UNIT PACKAGE: 1 Set

**14775**

Blank Labels  
5 pages of labels to be written on with a ball point pen.

UNIT PACKAGE: 1 Set



**DB-428L**

Body Shop Bin Labels

Self-adhesive, pre-printed labels for 428 very  
popular Auveco body shop items. These  
labels are based on the contents of our  
DB-428 Display Boards, which are the items  
that we recommend everyone stock.

Each label measures 2-13/16" x 1"  
and contains an Auveco part number,  
description, OEM number, photograph  
and unit package quantity. Included are 22  
blank labels for future new items.  
There are 15 pages in one set.

UNIT PACKAGE: 1 Set

# BODY SHOP BIN ASSORTMENTS

*Photos not actual size*

**Sec. 15**



Having the right part for the job is easy with our assortments for domestic and import vehicle applications. Each assortment contains 36 of the top selling retainers and clips along with a pre-labeled Auveco MB-36 bin.

This 36 compartment bin measures 23-5/8" wide x 4-3/4" deep x 23-5/8" high. In addition to showing the Auveco part number and bar code, the labels include O.E.M. numbers as well.

*Can be shipped via UPS*

## Domestic Vehicle "Xmas Tree" & Push-Type Retainers



**1052**

1 box each (1,130 pieces) of the following parts and a MB-36 bin:

|       |       |       |
|-------|-------|-------|
| 10831 | 12909 | 16818 |
| 11130 | 13993 | 17216 |
| 11146 | 13996 | 17222 |
| 11612 | 14010 | 17339 |
| 12137 | 14020 | 17612 |
| 12565 | 14021 | 17664 |
| 12567 | 14036 | 18033 |
| 12571 | 14753 | 18353 |
| 12731 | 14992 | 19422 |
| 12757 | 15456 | 19639 |
| 12759 | 15479 | 20192 |
| 12766 | 15543 | 20632 |

**1053**

Same as 1052 except without MB-36 bin.

## Import Vehicle Retaining Clips, Push-Type Retainers & Screw Grommets



**1054**

1 box each (601 pieces) of the following parts and a MB-36 bin:

|       |       |       |
|-------|-------|-------|
| 14260 | 18877 | 19729 |
| 14267 | 18888 | 20247 |
| 14737 | 19114 | 20327 |
| 16000 | 19118 | 20349 |
| 16858 | 19194 | 20380 |
| 17143 | 19233 | 20440 |
| 17379 | 19239 | 20564 |
| 17472 | 19246 | 20869 |
| 17632 | 19274 | 20908 |
| 18114 | 19453 | 20931 |
| 18297 | 19552 | 20955 |
| 18873 | 19721 | 20986 |

**1055**

Same as 1054 except without MB-36 bin.

*Photos not actual size*



Auveco offers one-price package assortments of popular U.S.S. and metric fasteners.

Each assortment contains one box each of 60 different fasteners that are all priced the same.

The assortments come in a sturdy, 5 shelf steel cabinet (15-1/2" x 32-1/2" x 4-1/4") that sits on a bench or can be wall mounted.

The assortments are shipped with the product already placed in the cabinet which is labeled with the fastener part numbers for easy re-stocking. Dimensions are clearly printed on the box labels to aid in quick selection of the proper part. All parts are available individually.

**70000**

**U.S.S. Coarse Thread Fasteners**

Contains one box each of the 60 numbers listed below. Includes cabinet.

| Part No.                         | Size            | U.P. Qty. | Part No.               | Size         | U.P. Qty. |
|----------------------------------|-----------------|-----------|------------------------|--------------|-----------|
| <b>GRADE 5 U.S.S. CAP SCREWS</b> |                 |           | <b>U.S.S. HEX NUTS</b> |              |           |
| 70100                            | 1/4-20 x 1/2    | 27        | 70132                  | 1/4-20       | 42        |
| 70101                            | 1/4-20 x 3/4    | 23        | 70133                  | 5/16-18      | 34        |
| 70102                            | 1/4-20 x 1      | 20        | 70134                  | 3/8-16       | 26        |
| 70103                            | 1/4-20 x 1-1/4  | 17        | 70135                  | 7/16-14      | 15        |
| 70104                            | 1/4-20 x 1-1/2  | 14        | 70136                  | 1/2-13       | 10        |
| 70105                            | 1/4-20 x 2      | 10        | <b>LOCK WASHERS</b>    |              |           |
| 70106                            | 5/16-18 x 3/4   | 17        | 70137                  | 1/4"         | 100       |
| 70107                            | 5/16-18 x 1     | 14        | 70138                  | 5/16"        | 85        |
| 70108                            | 5/16-18 x 1-1/4 | 11        | 70139                  | 3/8"         | 50        |
| 70109                            | 5/16-18 x 1-1/2 | 10        | 70140                  | 7/16"        | 40        |
| 70110                            | 5/16-18 x 1-3/4 | 9         | 70141                  | 1/2"         | 23        |
| 70111                            | 5/16-18 x 2     | 7         | <b>S.A.E. WASHERS</b>  |              |           |
| 70112                            | 5/16-18 x 2-1/2 | 6         | 70142                  | 1/4"         | 90        |
| 70113                            | 5/16-18 x 3     | 5         | 70143                  | 5/16"        | 80        |
| 70114                            | 3/8-16 x 3/4    | 11        | 70144                  | 3/8"         | 60        |
| 70115                            | 3/8-16 x 1      | 10        | 70145                  | 7/16"        | 50        |
| 70116                            | 3/8-16 x 1-1/4  | 9         | 70146                  | 1/2"         | 27        |
| 70117                            | 3/8-16 x 1-1/2  | 7         | <b>U.S.S. WASHERS</b>  |              |           |
| 70118                            | 3/8-16 x 1-3/4  | 7         | 70147                  | 1/4"         | 80        |
| 70119                            | 3/8-16 x 2      | 6         | 70148                  | 5/16"        | 50        |
| 70120                            | 3/8-16 x 2-1/4  | 6         | 70149                  | 3/8"         | 40        |
| 70121                            | 3/8-16 x 2-1/2  | 5         | 70150                  | 7/16"        | 20        |
| 70122                            | 3/8-16 x 3      | 4         | 70151                  | 1/2"         | 15        |
| 70123                            | 7/16-14 x 1     | 7         | <b>COTTER PINS</b>     |              |           |
| 70124                            | 7/16-14 x 1-1/4 | 6         | 70152                  | 1/16 x 1     | 125       |
| 70125                            | 7/16-14 x 1-1/2 | 5         | 70153                  | 3/32 x 1     | 100       |
| 70126                            | 7/16-14 x 2     | 4         | 70154                  | 3/32 x 1-1/2 | 80        |
| 70127                            | 7/16-14 x 2-1/2 | 4         | 70155                  | 1/8 x 1-1/2  | 50        |
| 70128                            | 1/2-13 x 1-1/2  | 4         | 70156                  | 1/8 x 2      | 35        |
| 70129                            | 1/2-13 x 2      | 3         | 70157                  | 5/32 x 1-1/2 | 30        |
| 70130                            | 1/2-13 x 2-1/2  | 3         | 70158                  | 5/32 x 2     | 25        |
| 70131                            | 1/2-13 x 3      | 2         | 70159                  | 3/16 x 2     | 20        |

**71000**

**Metric Standard Pitch & Fine Pitch Fasteners**

Contains one box each of the 60 numbers listed below. Includes cabinet.

| Part No.                         | Size           | U.P. Qty. | Part No.                     | Size            | U.P. Qty. |
|----------------------------------|----------------|-----------|------------------------------|-----------------|-----------|
| <b>STANDARD PITCH CAP SCREWS</b> |                |           | <b>LOCK WASHERS</b>          |                 |           |
| 71101                            | M5-.80 x 12MM  | 25        | 71134                        | 5MM             | 60        |
| 71102                            | M5-.80 x 25MM  | 20        | 71135                        | 6MM             | 45        |
| 71103                            | M6-1.0 x 10MM  | 20        | 71136                        | 8MM             | 25        |
| 71104                            | M6-1.0 x 12MM  | 20        | 71137                        | 10MM            | 20        |
| 71105                            | M6-1.0 x 16MM  | 18        | <b>FLAT WASHERS</b>          |                 |           |
| 71106                            | M6-1.0 x 20MM  | 17        | 71138                        | 5MM             | 60        |
| 71107                            | M6-1.0 x 25MM  | 16        | 71139                        | 6MM             | 50        |
| 71108                            | M6-1.0 x 30MM  | 14        | 71140                        | 8MM             | 42        |
| 71109                            | M6-1.0 x 40MM  | 13        | 71141                        | 10MM            | 24        |
| 71110                            | M6-1.0 x 45MM  | 11        | <b>COTTER PINS</b>           |                 |           |
| 71111                            | M8-1.25 x 12MM | 12        | 71142                        | 2MM x 20MM      | 82        |
| 71112                            | M8-1.25 x 16MM | 12        | 71143                        | 3MM x 25MM      | 60        |
| 71113                            | M8-1.25 x 20MM | 12        | 71144                        | 5MM x 45MM      | 20        |
| 71114                            | M8-1.25 x 25MM | 11        | <b>STUDS</b>                 |                 |           |
| 71115                            | M8-1.25 x 30MM | 10        | 71145                        | M8-1.25 x 35MM  | 3         |
| 71116                            | M8-1.25 x 35MM | 9         | 71146                        | M8-1.25 x 45MM  | 3         |
| 71117                            | M8-1.25 x 40MM | 8         | <b>FINE PITCH CAP SCREWS</b> |                 |           |
| 71118                            | M8-1.25 x 45MM | 7         | 71147                        | M8-1.0 x 40MM   | 6         |
| 71119                            | M8-1.25 x 50MM | 7         | 71148                        | M8-1.0 x 50MM   | 5         |
| 71120                            | M8-1.25 x 60MM | 6         | 71149                        | M10-1.0 x 30MM  | 4         |
| 71121                            | M8-1.25 x 75MM | 5         | 71150                        | M10-1.0 x 50MM  | 3         |
| 71122                            | M10-1.5 x 20MM | 6         | 71151                        | M10-1.25 x 20MM | 5         |
| 71123                            | M10-1.5 x 25MM | 6         | 71152                        | M10-1.25 x 25MM | 4         |
| 71124                            | M10-1.5 x 30MM | 5         | 71153                        | M10-1.25 x 30MM | 4         |
| 71125                            | M10-1.5 x 35MM | 5         | 71154                        | M10-1.25 x 35MM | 4         |
| 71126                            | M10-1.5 x 40MM | 5         | 71155                        | M10-1.25 x 40MM | 3         |
| 71127                            | M10-1.5 x 50MM | 4         | 71156                        | M10-1.25 x 50MM | 3         |
| 71128                            | M10-1.5 x 60MM | 4         | 71157                        | M10-1.25 x 60MM | 2         |
| 71129                            | M10-1.5 x 70MM | 3         | <b>FINE PITCH HEX NUTS</b>   |                 |           |
| <b>STANDARD PITCH HEX NUTS</b>   |                |           | 71158                        | M8-1.00         | 17        |
| 71130                            | M5-.80         | 41        | 71159                        | M10-1.00        | 12        |
| 71131                            | M6-1.0         | 25        | 71160                        | M10-1.25        | 9         |
| 71132                            | M8-1.25        | 17        |                              |                 |           |
| 71133                            | M10-1.5        | 15        |                              |                 |           |

# FASTENER ASSORTMENTS

*Photos not actual size*

**Sec. 15**



**Bin P40-S**

Each assortment includes an Auveco 40 compartment bin P40-S (33-3/4" Wide x 9" Deep x 24" High). The reorder labels contain the fastener part number, size, description and bar code. All parts are certified to meet or exceed the proper S.A.E. specifications both physically and chemically.

*Can be shipped via UPS*

## 1020

Grade 5 U.S.S. (Coarse Thread) Fastener Assortment.

Over 2,800 pieces of Grade 5 U.S.S. cap screws, hex nuts, high alloy lock washers and high alloy S.A.E. flat washers.

Diameters: 1/4"-20, 5/16"-18, 3/8"-16, 7/16"-14 and 1/2"-13.

Lengths: 1/2" through 3".

All fasteners are zinc plated.

*Refer to contents listing on next page.*

## 1021

Same as 1020 except without P40-S bin. Includes planogram and reorder labels.

## 1030

Grade 8 U.S.S. (Coarse Thread) Fastener Assortment.

Over 2,000 pieces of Grade 8 U.S.S. cap screws, hex nuts, high alloy lock washers and high alloy S.A.E. flat washers.

Diameters: 1/4"-20, 5/16"-18, 3/8"-16, 7/16"-14, 1/2"-13 and 5/8"-11.

Lengths: 1/2" through 4".

All fasteners are zinc and yellow dichromate plated.

*Refer to contents listing on next page.*

## 1031

Same as 1030 except without P40-S bin. Includes planogram and reorder labels.

# METRIC FASTENER ASSORTMENTS

## 1040

Metric Fastener (Regular Pitch) Assortment.

Over 1,200 metric cap screws, hex nuts, lock washers and flat washers.

Assortment comes with a pre-labeled Auveco 40 compartment bin, P40-S (33-3/4" Wide x 9" Deep x 24" High). The reorder labels contain the fastener part number, size, description and bar code.

Diameters: 6mm-1.00, 8mm-1.25, 10mm-1.50 and 12mm-1.75.

Lengths: 10mm through 50mm.

All fasteners are zinc plated.

*Refer to contents listing on next page.*

*Can be shipped via UPS*

## 1041

Same as 1040 except without P40-S Bin. Includes planogram and reorder labels.

## 1042

Metric Fastener (Regular & Fine Pitch) Assortment.

Over 1,995 metric cap screws, hex nuts, lock washers and flat washers.

Assortment comes with a pre-labeled Auveco 72 compartment bin, 72B-9, (33-3/4" wide x 9" deep x 42" high). The reorder labels contain the fastener part number, size, description and bar code.

Diameters: M5-.8, M6-1.0, M8-1.25, M8-1.0, M10-1.5, M10-1.25, M10-1.0 & M12-1.75.

Lengths: 10mm through 75mm.

All fasteners are zinc plated except fine pitch cap screws which have a black finish.

*Refer to contents listing on following pages.*

*Can be shipped via UPS*

## 1043

Same as 1042 except without 72-9 Bin. Includes planogram and reorder labels.

**1020 & 1021**

Grade 5 U.S.S. (Coarse Thread) Fastener Assortments. Contains 1 box each of:

|      |                             |       |                                |
|------|-----------------------------|-------|--------------------------------|
| 5434 | 1/4"-20 x 1/2" Cap Screw    | 5480  | 7/16"-14 x 2" Cap Screw        |
| 5436 | 1/4"-20 x 3/4" Cap Screw    | 5488  | 1/2"-13 x 1-1/2" Cap Screw     |
| 5438 | 1/4"-20 x 1" Cap Screw      | 5490  | 1/2"-13 x 2" Cap Screw         |
| 5439 | 1/4"-20 x 1-1/4" Cap Screw  | 5491  | 1/2"-13 x 2-1/2" Cap Screw     |
| 5440 | 1/4"-20 x 1-1/2" Cap Screw  | 5492  | 1/2"-13 x 3" Cap Screw         |
| 5442 | 1/4"-20 x 2" Cap Screw      | 11925 | 1/4" High Alloy Lock Washer    |
| 5449 | 5/16"-18 x 3/4" Cap Screw   | 11926 | 5/16" High Alloy Lock Washer   |
| 5451 | 5/16"-18 x 1" Cap Screw     | 11927 | 3/8" High Alloy Lock Washer    |
| 5452 | 5/16"-18 x 1-1/4" Cap Screw | 11928 | 7/16" High Alloy Lock Washer   |
| 5453 | 5/16"-18 x 1-1/2" Cap Screw | 11929 | 1/2" High Alloy Lock Washer    |
| 5455 | 5/16"-18 x 2" Cap Screw     | 12781 | 1/4" High Strength SAE Washer  |
| 5463 | 3/8"-16 x 3/4" Cap Screw    | 12782 | 5/16" High Strength SAE Washer |
| 5465 | 3/8"-16 x 1" Cap Screw      | 12783 | 3/8" High Strength SAE Washer  |
| 5466 | 3/8"-16 x 1-1/4" Cap Screw  | 12784 | 7/16" High Strength SAE Washer |
| 5467 | 3/8"-16 x 1-1/2" Cap Screw  | 12785 | 1/2" High Strength SAE Washer  |
| 5468 | 3/8"-16 x 1-3/4" Cap Screw  | 15586 | 1/4"-20 Grade 5 Hex Nut        |
| 5469 | 3/8"-16 x 2" Cap Screw      | 15587 | 5/16"-18 Grade 5 Hex Nut       |
| 5471 | 3/8"-16 x 2-1/2" Cap Screw  | 15588 | 3/8"-16 Grade 5 Hex Nut        |
| 5476 | 7/16"-14 x 1" Cap Screw     | 15589 | 7/16"-14 Grade 5 Hex Nut       |
| 5478 | 7/16"-14 x 1-1/2" Cap Screw |       | 1/2"-13 Grade 5 Hex Nut        |

**1030 & 1031**

Grade 8 U.S.S. (Coarse Thread) Fastener Assortments. Contains 1 box each of:

|      |                             |       |                                |
|------|-----------------------------|-------|--------------------------------|
| 9118 | 1/4"-20 x 1/2" Cap Screw    | 17499 | 5/8"-11 x 3-1/2" Cap Screw     |
| 9119 | 1/4"-20 x 3/4" Cap Screw    | 9164  | 5/8"-11 x 4" Cap Screw         |
| 9120 | 1/4"-20 x 1" Cap Screw      | 11925 | 1/4" High Alloy Lock Washer    |
| 9122 | 1/4"-20 x 1-1/2" Cap Screw  | 11926 | 5/16" High Alloy Lock Washer   |
| 9128 | 5/16"-18 x 3/4" Cap Screw   | 11927 | 3/8" High Alloy Lock Washer    |
| 9129 | 5/16"-18 x 1" Cap Screw     | 11928 | 7/16" High Alloy Lock Washer   |
| 9131 | 5/16"-18 x 1-1/2" Cap Screw | 11929 | 1/2" High Alloy Lock Washer    |
| 9137 | 3/8"-16 x 1" Cap Screw      | 11931 | 5/8" High Alloy Lock Washer    |
| 9138 | 3/8"-16 x 1-1/4" Cap Screw  | 12781 | 1/4" High Strength SAE Washer  |
| 9139 | 3/8"-16 x 1-1/2" Cap Screw  | 12782 | 5/16" High Strength SAE Washer |
| 9140 | 3/8"-16 x 2" Cap Screw      | 12783 | 3/8" High Strength SAE Washer  |
| 9141 | 3/8"-16 x 2-1/2" Cap Screw  | 12784 | 7/16" High Strength SAE Washer |
| 9146 | 7/16"-14 x 1-1/2" Cap Screw | 12785 | 1/2" High Strength SAE Washer  |
| 9147 | 7/16"-14 x 2" Cap Screw     | 12787 | 5/8" High Strength SAE Washer  |
| 9153 | 1/2"-13 x 1-1/2" Cap Screw  | 15640 | 1/4"-20 Grade 8 Hex Nut        |
| 9155 | 1/2"-13 x 2" Cap Screw      | 15641 | 5/16"-18 Grade 8 Hex Nut       |
| 9156 | 1/2"-13 x 2-1/2" Cap Screw  | 15642 | 3/8"-16 Grade 8 Hex Nut        |
| 9157 | 1/2"-13 x 3" Cap Screw      | 15643 | 7/16"-14 Grade 8 Hex Nut       |
| 9161 | 5/8"-11 x 2" Cap Screw      | 15644 | 1/2"-13 Grade 8 Hex Nut        |
| 9163 | 5/8"-11 x 3" Cap Screw      | 15645 | 5/8"-11 Grade 8 Hex Nut        |

**1040 & 1041**

Metric Fastener (Regular Pitch) Assortments. Contains 1 box each of:

|       |                                      |       |                                      |
|-------|--------------------------------------|-------|--------------------------------------|
| 14584 | 6mm-1.00 x 10mm Cap Screw (DIN 933)  | 14434 | 10mm-1.50 x 40mm Cap Screw (DIN 931) |
| 14407 | 6mm-1.00 x 12mm Cap Screw (DIN 933)  | 14435 | 10mm-1.50 x 45mm Cap Screw (DIN 931) |
| 14408 | 6mm-1.00 x 16mm Cap Screw (DIN 933)  | 14436 | 10mm-1.50 x 50mm Cap Screw (DIN 931) |
| 14409 | 6mm-1.00 x 20mm Cap Screw (DIN 933)  | 14440 | 12mm-1.75 x 25mm Cap Screw (DIN 933) |
| 14410 | 6mm-1.00 x 25mm Cap Screw (DIN 933)  | 14441 | 12mm-1.75 x 30mm Cap Screw (DIN 933) |
| 14411 | 6mm-1.00 x 30mm Cap Screw (DIN 931)  | 14442 | 12mm-1.75 x 35mm Cap Screw (DIN 933) |
| 14412 | 6mm-1.00 x 35mm Cap Screw (DIN 931)  | 14443 | 12mm-1.75 x 40mm Cap Screw (DIN 933) |
| 14413 | 6mm-1.00 x 40mm Cap Screw (DIN 931)  | 14445 | 12mm-1.75 x 50mm Cap Screw (DIN 931) |
| 14419 | 8mm-1.25 x 16mm Cap Screw (DIN 933)  | 14450 | 6mm-1.00 Hex Nut (DIN 934)           |
| 14420 | 8mm-1.25 x 20mm Cap Screw (DIN 933)  | 14452 | 8mm-1.25 Hex Nut (DIN 934)           |
| 14421 | 8mm-1.25 x 25mm Cap Screw (DIN 933)  | 14454 | 10mm-1.50 Hex Nut (DIN 934)          |
| 14422 | 8mm-1.25 x 30mm Cap Screw (DIN 933)  | 14455 | 12mm-1.75 Hex Nut (DIN 934)          |
| 14423 | 8mm-1.25 x 35mm Cap Screw (DIN 931)  | 10579 | 6mm Flat Washer (DIN 125)            |
| 14424 | 8mm-1.25 x 40mm Cap Screw (DIN 931)  | 10581 | 8mm Flat Washer (DIN 125)            |
| 14425 | 8mm-1.25 x 45mm Cap Screw (DIN 931)  | 10582 | 10mm Flat Washer (DIN 125)           |
| 14426 | 8mm-1.25 x 50mm Cap Screw (DIN 931)  | 10583 | 12mm Flat Washer (DIN 125)           |
| 14430 | 10mm-1.50 x 20mm Cap Screw (DIN 933) | 10586 | 6mm Lock Washer (DIN 127)            |
| 14431 | 10mm-1.50 x 25mm Cap Screw (DIN 933) | 10588 | 8mm Lock Washer (DIN 127)            |
| 14432 | 10mm-1.50 x 30mm Cap Screw (DIN 933) | 10589 | 10mm Lock Washer (DIN 127)           |
| 14433 | 10mm-1.50 x 35mm Cap Screw (DIN 933) | 10590 | 12mm Lock Washer (DIN 127)           |

## 1042 & 1043

Metric Fastener (Regular Pitch & Fine Pitch) Assortments. Contains 1 box each of:

### Cap Screw

|       |                  |           |
|-------|------------------|-----------|
| 14583 | 5mm-.8 x 12mm    | (DIN 933) |
| 14403 | 5mm-.8 x 16mm    | (DIN 933) |
| 14404 | 5mm-.8 x 20mm    | (DIN 933) |
| 14405 | 5mm-.8 x 25mm    | (DIN 933) |
| 14406 | 5mm-.8 x 30mm    | (DIN 933) |
| 15512 | 5mm-.8 x 40mm    | (DIN 933) |
| 14584 | 6mm-1.0 x 10mm   | (DIN 933) |
| 14407 | 6mm-1.0 x 12mm   | (DIN 933) |
| 14408 | 6mm-1.0 x 16mm   | (DIN 933) |
| 14409 | 6mm-1.0 x 20mm   | (DIN 933) |
| 14410 | 6mm-1.0 x 25mm   | (DIN 933) |
| 14411 | 6mm-1.0 x 30mm   | (DIN 931) |
| 14412 | 6mm-1.0 x 35mm   | (DIN 931) |
| 14413 | 6mm-1.0 x 40mm   | (DIN 931) |
| 14585 | 6mm-1.0 x 50mm   | (DIN 931) |
| 14588 | 8mm-1.25 x 12mm  | (DIN 933) |
| 14419 | 8mm-1.25 x 16mm  | (DIN 933) |
| 14420 | 8mm-1.25 x 20mm  | (DIN 933) |
| 14421 | 8mm-1.25 x 25mm  | (DIN 933) |
| 14422 | 8mm-1.25 x 30mm  | (DIN 933) |
| 14423 | 8mm-1.25 x 35mm  | (DIN 931) |
| 14424 | 8mm-1.25 x 40mm  | (DIN 931) |
| 14425 | 8mm-1.25 x 45mm  | (DIN 931) |
| 14426 | 8mm-1.25 x 50mm  | (DIN 931) |
| 14428 | 8mm-1.25 x 60mm  | (DIN 931) |
| 14429 | 8mm-1.25 x 70mm  | (DIN 933) |
| 14589 | 8mm-1.25 x 75mm  | (DIN 931) |
| 14430 | 10mm-1.5 x 20mm  | (DIN 933) |
| 14431 | 10mm-1.5 x 25mm  | (DIN 933) |
| 14432 | 10mm-1.5 x 30mm  | (DIN 933) |
| 14433 | 10mm-1.5 x 35mm  | (DIN 933) |
| 14434 | 10mm-1.5 x 40mm  | (DIN 931) |
| 14435 | 10mm-1.5 x 45mm  | (DIN 931) |
| 14436 | 10mm-1.5 x 50mm  | (DIN 931) |
| 14438 | 10mm-1.5 x 60mm  | (DIN 931) |
| 14439 | 10mm-1.5 x 70mm  | (DIN 931) |
| 14440 | 12mm-1.75 x 25mm | (DIN 933) |
| 14441 | 12mm-1.75 x 30mm | (DIN 933) |
| 14442 | 12mm-1.75 x 35mm | (DIN 933) |
| 14443 | 12mm-1.75 x 40mm | (DIN 933) |
| 14445 | 12mm-1.75 x 50mm | (DIN 931) |
| 14446 | 12mm-1.75 x 60mm | (DIN 931) |
| 14447 | 12mm-1.75 x 70mm | (DIN 931) |

### Hex Nut

|       |           |           |
|-------|-----------|-----------|
| 14449 | 5mm-.8    | (DIN 934) |
| 14450 | 6mm-1.0   | (DIN 934) |
| 14452 | 8mm-1.25  | (DIN 934) |
| 14454 | 10mm-1.5  | (DIN 934) |
| 14455 | 12mm-1.75 | (DIN 934) |

### Flat Washer

|       |      |           |
|-------|------|-----------|
| 10578 | 5mm  | (DIN 125) |
| 10579 | 6mm  | (DIN 125) |
| 10581 | 8mm  | (DIN 125) |
| 10582 | 10mm | (DIN 125) |
| 10583 | 12mm | (DIN 125) |

### Lock Washer

|       |      |           |
|-------|------|-----------|
| 10585 | 5mm  | (DIN 127) |
| 10586 | 6mm  | (DIN 127) |
| 10588 | 8mm  | (DIN 127) |
| 10589 | 10mm | (DIN 127) |
| 10590 | 12mm | (DIN 127) |

### Fine Cap Screw

|       |                  |           |
|-------|------------------|-----------|
| 11257 | 8mm-1.0 x 25mm   | (DIN 961) |
| 14604 | 8mm-1.0 x 50mm   | (DIN 960) |
| 14605 | 10mm-1.25 x 20mm | (DIN 961) |
| 11265 | 10mm-1.25 x 25mm | (DIN 961) |
| 11266 | 10mm-1.25 x 30mm | (DIN 961) |
| 11267 | 10mm-1.25 x 35mm | (DIN 961) |
| 11268 | 10mm-1.25 x 40mm | (DIN 961) |
| 11269 | 10mm-1.25 x 50mm | (DIN 961) |
| 14606 | 10mm-1.25 x 60mm | (DIN 961) |
| 11262 | 10mm-1.0 x 30mm  | (DIN 961) |
| 11264 | 10mm-1.0 x 50mm  | (DIN 961) |

### Fine Pitch Hex Nut

|       |           |           |
|-------|-----------|-----------|
| 14453 | 8mm-1.0   | (DIN 934) |
| 14457 | 10mm-1.25 | (DIN 934) |
| 14456 | 10mm-1.0  | (DIN 934) |

*Photos not actual size*



Auveco offers more than 40 prepackaged Fix-Kits in the 6000 series small drawer. Each drawer measures 13-5/16" wide x 9-1/4" deep x 2" high.

Printed lid labels identify the correct Auveco part number for ordering refills.

**“6000” Series Small Drawer Fix-Kit Numeric Listing**

*Refer to contents listing on following pages*

| Auveco Part No. | Description                         |
|-----------------|-------------------------------------|
| 6003            | Phillips Oval Head Tapping Screws   |
| 6004            | Special Tapping Screws              |
| 6007            | Tubular, Flat, U & J-Nuts           |
| 6011            | Round Head Machine Screws & Nuts    |
| 6038            | Phillips Pan Head Tapping Screws    |
| 6043            | Thread Cutting & Washer Lock Nuts   |
| 6051            | Cotter Pins                         |
| 6062            | Plug Buttons                        |
| 6065            | Woodruff Keys                       |
| 6070            | Internal & External Lock Washers    |
| 6073            | Socket Head Set Screws              |
| 6085            | O-Rings                             |
| 6086            | Throttle Rod Clips & E-Clips        |
| 6112            | Cotter Pins                         |
| 6116            | Internal & External Retaining Rings |
| 6123            | E-Rings                             |
| 6124            | Spring Pins                         |
| 6125            | Spring Pins                         |

| Auveco Part No. | Description                             |
|-----------------|---|
| 6128            | Grease Fittings                         |
| 6133            | Insulated Closed Clamps                 |
| 6144            | Teks® Tapping Screws                    |
| 6158            | Metric Cotter Pins                      |
| 6160            | Metric Cap Screws & Nuts                |
| 6162            | “Xmas Tree” Retainers                   |
| 6164            | Pushnut Bolt Retainers                  |
| 6166            | Body & Fender Shims                     |
| 6167            | Tee Connectors                          |
| 6168            | Hose Connectors                         |
| 6172            | Metric Pushnut Bolt & Push-On Retainers |
| 6173            | Solderless Terminals                    |
| 6175            | Solderless Terminals                    |
| 6176            | Thread Repair Inserts                   |
| 6178            | O.E.M. Electrical Terminals             |
| 6182            | Phillips Washer Head Tapping Screws     |
| 6186            | Oil Drain Plugs & Gaskets               |
| 6187            | Metric Grease Fittings                  |

**“6000” Series/ “6500” Series Kit Cross Reference**

*The 6600 Series Body Hardware Master Assortments are listed on pages 324-331*

| 6000 Kit | 6500 Kit |
|----------|----------|
| 6003     | 6501     |
| 6007     | 6502     |
| 6011     | 6503     |
| 6065     | 6504     |
| 6085     | 6505     |
| 6112     | 6506     |
| 6116     | 6507     |
| 6123     | 6058     |

| 6000 Kit | 6500 Kit |
|----------|----------|
| 6124     | 6509     |
| 6125     | 6510     |
| 6128     | 6511     |
| 6144     | 6536     |
| 6160     | 6513     |
| 6178     | 6543     |
| 6182     | 6530     |
| 6186     | 6534     |

# "6000" SERIES SMALL DRAWER FIX-KITS

**Sec. 15**

*Photos not actual size*



## 6003 Fix-Kit

Phillips Oval Head Tapping Screws  
Zinc & Chrome Plated  
24 Varieties - 540 Pieces

| Auveco Part No. | Size         | Head  |
|-----------------|--------------|-------|
| 3069            | #4 x 3/4"    |       |
| 1793            | #6 x 5/8"    |       |
| 1794            | #6 x 3/4"    |       |
| 1796            | #6 x 1"      |       |
| 1797            | #6 x 1-1/4"  |       |
| 2024            | #8 x 3/8"    | No. 6 |
| 2358            | #8 x 1/2"    |       |
| 2027            | #8 x 1/2"    | No. 6 |
| 1421            | #8 x 5/8"    | No. 6 |
| 1799            | #8 x 3/4"    | No. 6 |
| 2359            | #8 x 3/4"    |       |
| 1801            | #8 x 1"      | No. 6 |
| 1802            | #8 x 1-1/8"  | No. 6 |
| 2361            | #8 x 1-1/4"  |       |
| 1803            | #8 x 1-1/4"  | No. 6 |
| 2362            | #8 x 1-1/2"  |       |
| 1932            | #8 x 1-1/2"  | No. 6 |
| 1933            | #8 x 1-3/4"  | No. 6 |
| 1717            | #10 x 3/4"   | No. 8 |
| 2728            | #10 x 3/4"   |       |
| 1804            | #10 x 1"     | No. 6 |
| 1807            | #10 x 1-1/8" |       |
| 2046            | #10 x 1-1/2" | No. 6 |
| 2665            | #10 x 2"     | No. 8 |



## 6038 Fix-Kit

Phillips Pan Head Tapping Screws  
Zinc Plated  
20 Varieties - 1385 Pieces

| Auveco Part No. | Size        |
|-----------------|-------------|
| 3071            | #4 x 1/4"   |
| 3072            | #4 x 3/8"   |
| 3073            | #4 x 1/2"   |
| 3074            | #4 x 3/4"   |
| 3075            | #4 x 1"     |
| 1935            | #6 x 1/4"   |
| 1936            | #6 x 3/8"   |
| 1937            | #6 x 1/2"   |
| 5621            | #6 x 5/8"   |
| 2364            | #6 x 3/4"   |
| 3076            | #6 x 1"     |
| 3077            | #6 x 1-1/4" |
| 3078            | #6 x 1-1/2" |
| 1939            | #8 x 3/8"   |
| 1940            | #8 x 1/2"   |
| 5625            | #8 x 5/8"   |
| 2365            | #8 x 3/4"   |
| 3079            | #8 x 1"     |
| 3080            | #8 x 1-1/4" |
| 3081            | #8 x 1-1/2" |



## 6004 Fix-Kit

Phillips Specialty Tapping Screws  
Zinc Plated  
24 Varieties - 795 Pieces



| Auveco Part No. | Size       | Head  |
|-----------------|------------|-------|
| 1936            | #6 x 3/8"  |       |
| 1937            | #6 x 1/2"  |       |
| 2364            | #6 x 3/4"  |       |
| 1939            | #8 x 3/8"  |       |
| 10642           | #8 x 3/8"  |       |
| 2805            | #8 x 7/16" |       |
| 1940            | #8 x 1/2"  |       |
| 12095           | #8 x 1/2"  |       |
| 14859           | #8 x 1/2"  |       |
| 15171           | #8 x 1/2"  |       |
| 15172           | #8 x 1/2"  |       |
| 1712            | #8 x 3/4"  | No. 6 |
| 2365            | #8 x 3/4"  |       |
| 3079            | #8 x 1"    |       |
| 2178            | #10 x 3/8" |       |
| 1943            | #10 x 1/2" |       |
| 2808            | #10 x 5/8" |       |
| 13709           | #10 x 3/4" |       |
| 2366            | #10 x 3/4" |       |
| 3082            | #10 x 1"   |       |
| 2367            | #12 x 3/4" |       |
| 3086            | #12 x 1"   |       |
| 3089            | #14 x 1/2" |       |
| 3090            | #14 x 3/4" |       |



## 6182 Fix-Kit

Phillips Flat Top Washer Head  
Tapping Screws  
Black E-Coat & Zinc Plated  
12 Varieties - 1790 Pieces

| Auveco Part No. | Size        | Plating      |
|-----------------|-------------|--------------|
| 12950           | #6 x 1/2"   | Black E-Coat |
| 12951           | #6 x 3/4"   | Black E-Coat |
| 12213           | #8 x 1/2"   | Black E-Coat |
| 12214           | #8 x 5/8"   | Black E-Coat |
| 12215           | #8 x 3/4"   | Black E-Coat |
| 12216           | #8 x 1"     | Black E-Coat |
| 12217           | #8 x 1-1/4" | Black E-Coat |
| 12218           | #8 x 1-1/2" | Black E-Coat |
| 12953           | #10 x 3/4"  | Black E-Coat |
| 12954           | #10 x 1"    | Black E-Coat |
| 14859           | #8 x 1/2"   | Zinc         |
| 14861           | #8 x 3/4"   | Zinc         |



*Photos not actual size*

**6144 Fix-Kit**

Teks® Self-Drilling Screws  
Phillips Pan Head  
Hex Washer Head  
Zinc Plated  
16 Sizes - 365 Pieces



| Auveco Part No. | Size         | Head |
|-----------------|--------------|------|
| 9605            | #8 x 1/2"    | Pan  |
| 9606            | #8 x 3/4"    | Pan  |
| 9607            | #10 x 1/2"   | Pan  |
| 9608            | #10 x 3/4"   | Pan  |
| 11905           | #12 x 1"     | Pan  |
| 9611            | #8 x 1/2"    | Hex  |
| 9612            | #8 x 3/4"    | Hex  |
| 9613            | #10 x 1/2"   | Hex  |
| 9614            | #10 x 5/8"   | Hex  |
| 9615            | #10 x 3/4"   | Hex  |
| 9616            | #10 x 1"     | Hex  |
| 11911           | #12 x 1"     | Hex  |
| 9620            | #14 x 3/4"   | Hex  |
| 11914           | #14 x 1"     | Hex  |
| 11915           | #14 x 1-1/4" | Hex  |
| 11916           | #14 x 1-1/2" | Hex  |

**6011 Fix-Kit**

Slotted Round Head  
Machine Screws  
Zinc Plated  
19 Varieties of Screws  
5 Varieties of Nuts - 1110 Pieces



| Auveco Part No. | Size           |
|-----------------|----------------|
| <b>Nut</b>      |                |
| 727             | 6-32           |
| 728             | 8-32           |
| 729             | 10-32          |
| 730             | 10-24          |
| 731             | 12-24          |
| <b>Screw</b>    |                |
| 2530            | 6-32 x 1/2"    |
| 2531            | 6-32 x 3/4"    |
| 2532            | 6-32 x 1"      |
| 2533            | 8-32 x 1/2"    |
| 2534            | 8-32 x 3/4"    |
| 2535            | 8-32 x 1"      |
| 2536            | 10-32 x 1/2"   |
| 2537            | 10-32 x 3/4"   |
| 2538            | 10-32 x 1"     |
| 2539            | 10-32 x 1-1/4" |
| 2540            | 10-32 x 1-1/2" |
| 2541            | 10-24 x 1/2"   |
| 2542            | 10-24 x 3/4"   |
| 2543            | 10-24 x 1"     |
| 2544            | 10-24 x 1-1/4" |
| 2545            | 10-24 x 1-1/2" |
| 2546            | 12-24 x 1/2"   |
| 2548            | 12-24 x 1"     |
| 2550            | 12-24 x 1-1/2" |

**6160 Fix-Kit**

Metric Regular Pitch • DIN 933  
Cap Screws & Nuts  
Zinc Plated  
12 Varieties of Screws  
4 Varieties of Nuts - 236 Pieces



| Auveco Part No. | Size           |
|-----------------|----------------|
| <b>Screw</b>    |                |
| 14400           | M4-.7 x 16mm   |
| 14401           | M4-.7 x 20mm   |
| 14402           | M5-.8 x 10mm   |
| 14403           | M5-.8 x 16mm   |
| 14404           | M5-.8 x 20mm   |
| 14405           | M5-.8 x 25mm   |
| 14408           | M6-1.0 x 16mm  |
| 14409           | M6-1.0 x 20mm  |
| 14410           | M6-1.0 x 25mm  |
| 14420           | M8-1.25 x 20mm |
| 14421           | M8-1.25 x 25mm |
| 14422           | M8-1.25 x 30mm |
| <b>Nut</b>      |                |
| 14448           | M4-.7          |
| 14449           | M5-.8          |
| 14450           | M6-1.0         |
| 14452           | M8-1.25        |

**6073 Fix-Kit**

Socket Head Set Screws  
47 Varieties Screws - 540 Pieces



| Auveco Part No. | Size         |              |
|-----------------|--------------|--------------|
| 5366            | 6-32 x 1/4"  |              |
| 5367            | 6-32 x 5/16" |              |
| 5368            | 6-32 x 3/8"  |              |
| 5370            | 8-32 x 1/4"  |              |
| 5371            | 8-32 x 5/16" |              |
| 5372            | 8-32 x 3/8"  |              |
| 5373            | 8-32 x 1/2"  |              |
| Auveco Part No. | Size         |              |
| USS             | SAE          | Size         |
| 5374            | 5394         | 10 x 3/16"   |
| 5375            | 5395         | 10 x 1/4"    |
| 5376            | 5396         | 10 x 5/16"   |
| 5377            | 5397         | 10 x 3/8"    |
| 5378            | 5398         | 10 x 1/2"    |
| 5379            | 5399         | 1/4 x 1/4"   |
| 5380            | 5400         | 1/4 x 5/16"  |
| 5381            | 5401         | 1/4 x 3/8"   |
| 5382            | 5402         | 1/4 x 7/16"  |
| 5383            | 5403         | 1/4 x 1/2"   |
| 5384            | 5404         | 5/16 x 1/4"  |
| 5385            | 5405         | 5/16 x 5/16" |
| 5386            | 5406         | 5/16 x 3/8"  |
| 5387            | 5407         | 5/16 x 7/16" |
| 5388            | 5408         | 5/16 x 1/2"  |
| 5389            | 5409         | 3/8 x 5/16"  |
| 5390            | 5410         | 3/8 x 3/8"   |
| 5391            | 5411         | 3/8 x 7/16"  |
| 5392            | 5412         | 3/8 x 1/2"   |
| 5393            | 5413         | 3/8 x 5/8"   |

# "6000" SERIES SMALL DRAWER FIX-KITS

**Sec. 15**

*Photos not actual size*



## 6007 Fix-Kit

Tubular, Flat, U & J Nuts  
24 Varieties - 515 Pieces

| Auveco Part No. | Size       | Type     |
|-----------------|------------|----------|
| 1903            | 1/4"-20    | Flat     |
| 2089            | #6-32      | Flat     |
| 2092            | #10-24     | Flat     |
| 2099            | 1/8" Stud  | Flat     |
| 2103            | 3/16" Stud | Flat     |
| 2105            | 1/4" Stud  | Flat     |
| 2293            | 1/4"-20    | U-Nut    |
| 2346            | #8         | J-Nut    |
| 2422            | #10        | U-Nut    |
| 2595            | 1/8" Stud  | Tubular  |
| 2611            | 1/8" Stud  | Tubular  |
| 5170            | 3/8"-16    | J Cage   |
| 5197            | #10-24     | U-Nut    |
| 5586            | 1/4"-20    | J Cage   |
| 5589            | 5/16"-18   | J Cage   |
| 9879            | #8         | Spring U |
| 9880            | #8         | Spring U |
| 10064           | #6         | Spring U |
| 10065           | #8         | Spring U |
| 10066           | #10        | Spring U |
| 10067           | #14        | Spring U |
| 10666           | #8         | U-Nut    |
| 11292           | #8         | U-Nut    |
| 11429           | #10        | U-Nut    |



## 6070 Fix-Kit

Shakeproof  
Lock Washers  
(External,  
Internal & Countersunk)  
Zinc Plated  
24 Varieties - 1450 Pieces



| Auveco Part No. | Size  | Type        |
|-----------------|-------|-------------|
| 5249            | #4    | External    |
| 5259            | #4    | Internal    |
| 5250            | #6    | External    |
| 5260            | #6    | Internal    |
| 5270            | #6    | Countersunk |
| 5251            | #8    | External    |
| 5261            | #8    | Internal    |
| 5271            | #8    | Countersunk |
| 5252            | #10   | External    |
| 5262            | #10   | Internal    |
| 5272            | #10   | Countersunk |
| 5253            | #12   | External    |
| 5263            | #12   | Internal    |
| 5254            | 1/4"  | External    |
| 5264            | 1/4"  | Internal    |
| 5255            | 5/16" | External    |
| 5265            | 5/16" | Internal    |
| 5256            | 3/8"  | External    |
| 5266            | 3/8"  | Internal    |
| 5257            | 7/16" | External    |
| 5267            | 7/16" | Internal    |
| 5258            | 1/2"  | External    |
| 5268            | 1/2"  | Internal    |
| 5274            | 1/4"  | Countersunk |



## 6186 Fix-Kit

Oil Drain Plugs & Gaskets  
12 Varieties - 80 Pieces



| Auveco Part No. | Size            |
|-----------------|-----------------|
| 14196           | 1/2"-20         |
| 18373           | 1/2"-20         |
| 18121           | 1/2"-20         |
|                 | Double Oversize |
| 15527           | M12-1.25        |
| 14677           | M12-1.75        |
| 18374           | M12-1.75        |
| 21047           | M12-1.75        |
| 14678           | M14-1.5         |
| 16308           | M14-1.5         |
| 19279           | M14-1.5         |
| 19773           | M14-1.5         |
| 15529           | M18-1.5         |

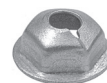

## 6043 Fix-Kit

Washer Lock Nuts  
& Thread Cutting Nuts  
16 Varieties - 1235 Pieces



| Auveco Part No. | Size       |
|-----------------|------------|
| 2554            | #6-32      |
| 2555            | #8-32      |
| 2556            | #10-32     |
| 2557            | #10-24     |
| 2560            | #12-24     |
| 2561            | 1/4"-20    |
| 2562            | 1/4"-20    |
| 2895            | 1/8" Stud  |
| 2896            | 3/16" Stud |
| 2897            | 1/4" Stud  |
| 3403            | 1/8" Stud  |
| 3404            | 3/16" Stud |
| 3405            | 1/4" Stud  |
| 8855            | 5/32" Stud |
| 10733           | 5/16" Stud |
| 12253           | 5mm Stud   |



## 6164 Fix-Kit

Pushnut Bolt Retainer  
8 Sizes - 1350 Pieces

| Auveco Part No. | For Bolt Diameter |
|-----------------|-------------------|
| 16851           | 9/64" (#6)        |
| 10085           | 5/32" (#8)        |
| 16852           | 3/16" (#10)       |
| 10086           | 1/4"              |
| 10087           | 5/16"             |
| 9297            | 3/8"              |
| 9298            | 7/16"             |
| 9299            | 1/2"              |

*Photos not actual size*



**6172 Fix-Kit**

Metric Pushnut Bolt Retainers & Push-On Retainers  
10 Sizes - 745 Pieces



| Auveco Part No. | Bolt or Stud Size |
|-----------------|-------------------|
| 12119           | 4.0mm Stud        |
| 12122           | M5-.8             |
| 12123           | M6-1.0            |
| 14980           | M6-1.0            |
| 12124           | M6.3-1.0          |
| 12125           | M8-1.25           |
| 12259           | M8-1.25           |
| 12126           | M10-1.50          |
| 12260           | M10-1.50          |
| 12127           | M12-1.75          |



**6086 Fix-Kit**

Rod End Clips & E-Clips  
16 Varieties - 560 Pieces

| Auveco Part No.      | Shaft Diameter |            |
|----------------------|----------------|------------|
| <b>Rod End Clips</b> |                |            |
| 3609                 | 5/32"          | Right Side |
| 3610                 | 5/32"          | Left Side  |
| 3611                 | 3/16"          | Right Side |
| 3612                 | 3/16"          | Left Side  |
| 3613                 | 1/4"           | Right Side |
| 3614                 | 1/4"           | Left Side  |
| <b>E-Clips</b>       |                |            |
| 3165                 | 1/8"           |            |
| 3166                 | 3/16"          |            |
| 3167                 | 1/4"           |            |
| 3824                 | 5/16"          | Small O.D. |
| 3628                 | 5/16"          | Large O.D. |
| 5600                 | 3/8"           |            |
| 2672                 | 7/16"          |            |
| 5602                 | 1/2"           |            |
| 5601                 | 9/16"          |            |
| 5603                 | 5/8"           |            |

**FasTrack Web recently underwent a complete renovation.**

**One of it's newest features includes several pre-loaded kits used for collision repairs.**

**FasTrack is Auveco's body cost recovery system.**

**Go to [www.auveco.com](http://www.auveco.com) to learn more and start saving your body shop money**



**6123 Fix-Kit**

E & Reinforced E-Rings  
Groove Required  
24 Varieties - 1500 Pieces



| Auveco Part No. | Shaft Diameter | Type         |
|-----------------|----------------|--------------|
| 8824            | 1/16"          | E-Type       |
| 8825            | 3/32"          | E-Type       |
| 8836            | 3/32"          | Reinforced E |
| 3165            | 1/8"           | Reinforced E |
| 8826            | 1/8"           | E-Type       |
| 3166            | 3/16"          | Reinforced E |
| 8827            | 3/16"          | E-Type       |
| 3167            | 1/4"           | Reinforced E |
| 8828            | 1/4"           | E-Type       |
| 3628            | 5/16"          | Reinforced E |
| 3824            | 5/16"          | E-Type       |
| 5600            | 3/8"           | Reinforced E |
| 8829            | 3/8"           | E-Type       |
| 2672            | 7/16"          | Reinforced E |
| 8830            | 7/16"          | E-Type       |
| 8837            | 1/2"           | Reinforced E |
| 5602            | 1/2"           | E-Type       |
| 5601            | 9/16"          | Reinforced E |
| 5603            | 5/8"           | E-Type       |
| 8831            | 3/4"           | E-Type       |
| 8832            | 7/8"           | E-Type       |
| 8833            | 1"             | E-Type       |
| 8834            | 1-3/16"        | E-Type       |
| 8835            | 1-3/8"         | E-Type       |

**6112 Fix-Kit**

Hammer-lock Cotter Pins  
Bright Zinc Chromate  
16 Varieties - 1500 Pieces



| Auveco Part No. | Size           |
|-----------------|----------------|
| 8477            | 1/16" x 1/2"   |
| 8478            | 1/16" x 3/4"   |
| 8479            | 1/16" x 1"     |
| 8480            | 1/16" x 1-1/2" |
| 8481            | 3/32" x 3/4"   |
| 8482            | 3/32" x 1"     |
| 8484            | 3/32" x 1-1/2" |
| 8485            | 3/32" x 2"     |
| 8486            | 1/8" x 1"      |
| 8487            | 1/8" x 1-1/4"  |
| 8488            | 1/8" x 1-1/2"  |
| 8490            | 1/8" x 2"      |
| 8491            | 1/8" x 1-1/2"  |
| 8492            | 5/32" x 1"     |
| 8493            | 5/32" x 1-1/2" |
| 8494            | 5/32" x 2"     |

# "6000" SERIES SMALL DRAWER FIX-KITS

*Photos not actual size*

**Sec. 15**

## 6051 Fix-Kit

Hammer-lock Cotter Pins  
Plain Steel  
18 Varieties - 2790 Pieces



| Auveco Part No. | Size           |
|-----------------|----------------|
| 3502            | 1/16" x 1/2"   |
| 3503            | 1/16" x 3/4"   |
| 3504            | 1/16" x 1"     |
| 3505            | 1/16" x 1-1/4" |
| 3506            | 1/16" x 1-1/2" |
| 3508            | 1/16" x 2"     |
| 3509            | 3/32" x 1/2"   |
| 8481*           | 3/32" x 3/4"   |
| 3511            | 3/32" x 1"     |
| 3512            | 3/32" x 1-1/4" |
| 3513            | 3/32" x 1-1/2" |
| 3515            | 3/32" x 2"     |
| 3519            | 1/8" x 3/4"    |
| 3520            | 1/8" x 1"      |
| 3521            | 1/8" x 1-1/4"  |
| 3522            | 1/8" x 1-1/2"  |
| 8489*           | 1/8" x 1-3/4"  |
| 3524            | 1/8" x 2"      |

\*Plated

## 6158 Fix-Kit

Metric Cotter Pins  
12 Sizes - 580 Pieces



| Auveco Part No. | Size     |
|-----------------|----------|
| 10553           | 2 x 18mm |
| 10554           | 2 x 20mm |
| 10556           | 2 x 25mm |
| 10558           | 3 x 25mm |
| 10559           | 3 x 30mm |
| 10560           | 3 x 35mm |
| 10562           | 4 x 30mm |
| 10563           | 4 x 35mm |
| 10564           | 4 x 40mm |
| 10566           | 5 x 35mm |
| 10567           | 5 x 40mm |
| 10568           | 5 x 45mm |



## 6116 Fix-Kit

Basic Internal &  
External Rings  
Zinc Plated  
24 Varieties -  
1000 Pieces



| Auveco Part No.      | Shaft Diameter |
|----------------------|----------------|
| <b>Internal Type</b> |                |
| 8688                 | 1/4"           |
| 8689                 | 5/16"          |
| 8690                 | 3/8"           |
| 8691                 | 7/16"          |
| 8692                 | 1/2"           |
| 8693                 | 9/16"          |
| 8694                 | 5/8"           |
| 8695                 | 3/4"           |
| 8696                 | 7/8"           |
| 8697                 | 1"             |
| 8698                 | 1-1/8"         |
| 8699                 | 1-1/4"         |
| <b>External Type</b> |                |
| 8701                 | 1/4"           |
| 8702                 | 5/16"          |
| 8703                 | 3/8"           |
| 8704                 | 7/16"          |
| 8705                 | 1/2"           |
| 8706                 | 9/16"          |
| 8707                 | 5/8"           |
| 8708                 | 3/4"           |
| 8709                 | 7/8"           |
| 8710                 | 1"             |
| 8711                 | 1-1/8"         |
| 8712                 | 1-1/4"         |



## 6085 Fix-Kit

Rubber O-Rings  
20 Varieties - 300 Pieces

| Auveco Part No. | Inside Diameter | Outside Diameter |
|-----------------|-----------------|------------------|
| 4305            | 1/8"            | 1/4"             |
| 4306            | 5/32"           | 9/32"            |
| 4307            | 3/16"           | 5/16"            |
| 4308            | 7/32"           | 11/32"           |
| 4309            | 1/4"            | 3/8"             |
| 4310            | 5/16"           | 7/16"            |
| 4311            | 3/8"            | 1/2"             |
| 4312            | 3/8"            | 9/16"            |
| 4313            | 7/16"           | 5/8"             |
| 4314            | 1/2"            | 11/16"           |
| 4315            | 9/16"           | 3/4"             |
| 4316            | 5/8"            | 13/16"           |
| 4317            | 11/16"          | 7/8"             |
| 4318            | 3/4"            | 15/16"           |
| 4319            | 3/4"            | 1"               |
| 4320            | 13/16"          | 1-1/16"          |
| 4321            | 7/8"            | 1-1/8"           |
| 4322            | 15/16"          | 1-3/16"          |
| 4323            | 1"              | 1-1/4"           |
| 4324            | 1-1/16"         | 1-5/16"          |

*Photos not actual size*



**6175 Fix-Kit**

Vinyl Insulated  
Solderless Terminals  
24 Varieties - 164 Pieces

| Auveco Part No. | Gauge | Wire Size    | Stud Type            |
|-----------------|-------|--------------|----------------------|
| 5023            | 22-18 | #8 - #10     | Ring                 |
| 5026            | 16-14 | #8 - #10     | Ring                 |
| 5027            | 16-14 | #12 - 1/4"   | Ring                 |
| 5028            | 12-10 | #8 - #10     | Ring                 |
| 5029            | 12-10 | #12 - 1/4"   | Ring                 |
| 5030            | 12-10 | 1/4" - 5/16" | Ring                 |
| 5031            | 12-10 | 5/16" - 3/8" | Ring                 |
| 5047            | 22-18 |              | Butt Connector       |
| 5048            | 16-14 |              | Butt Connector       |
| 5049            | 12-10 |              | Butt Connector       |
| 5067            | 16-14 |              | Male Quick-Connect   |
| 5068            | 16-14 |              | Female Quick-Connect |
| 8781            | 16-14 |              | Female Quick-Connect |
| 9481            | 18-14 |              | Electrical Connector |
| 10719           | 16-14 |              | Female Bullet Plug   |
| 11602           | 16-14 |              | Female Bullet Plug   |
| 11605           | 16-14 |              | Male Quick-Connect   |
| 11606           | 16-14 |              | Female Quick-Connect |
| 12144           | 16-14 | 5/16" - 3/8" | Ring                 |
| 12154           | 22-18 |              | Male Quick-Connect   |
| 12155           | 22-18 |              | Female Quick-Connect |
| 12156           | 12-10 |              | Male Quick-Connect   |
| 12157           | 12-10 |              | Female Quick-Connect |
| 12161           | 18-14 |              | Tap Connector        |



**6173 Fix-Kit**

Insulated Solderless Terminals  
24 Varieties - 128 Pieces

| Auveco Part No. | Gauge | Wire Size    | Stud Type                  |
|-----------------|-------|--------------|----------------------------|
| 5791            | 22-16 |              | Butt Connector             |
| 5792            | 16-14 |              | Butt Connector             |
| 5793            | 12-10 |              | Butt Connector             |
| 9052            | 16-14 | #4 - #6      | Nylon Insulated Ring       |
| 9055            | 16-14 | #8 - #10     | Nylon Insulated Ring       |
| 9056            | 16-14 | #12 - 1/4"   | Nylon Insulated Ring       |
| 9057            | 16-14 | 1/4" - 5/16" | Nylon Insulated Ring       |
| 9060            | 16-14 | #8 - #10     | Nylon Insulated Spade      |
| 9481            | 18-14 |              | Electrical Connector       |
| 10719           | 16-14 |              | Female Snap Plug           |
| 11602           | 16-14 |              | Female Snap Plug           |
| 11605           | 16-14 |              | Male Quick Slide           |
| 11606           | 16-14 |              | Female Quick Slide         |
| 12145           | 16-14 |              | Nylon Bullet Connector     |
| 12146           | 16-14 |              | Nylon Bullet Connector     |
| 12147           | 18-14 |              | Nylon Male Quick Connect   |
| 12148           | 16-14 |              | Nylon Female Quick Connect |
| 12149           | 22-18 | #6           | Nylon Insulated Ring       |
| 12150           | 22-18 | #10          | Nylon Insulated Ring       |
| 12151           | 12-10 | #10          | Nylon Insulated Ring       |
| 12152           | 12-10 | 1/4"         | Nylon Insulated Ring       |
| 12153           | 12-10 | 3/8"         | Nylon Insulated Ring       |
| 12161           | 18-14 |              | Tap Connector              |
| 12791           | 22-18 |              | Tap Connector              |

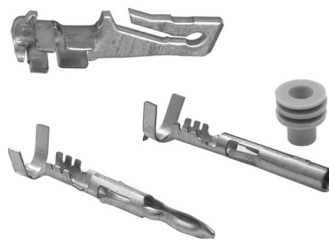

**6178 Fix-Kit**

O.E.M. Electrical  
Terminals & Tools  
GM, Ford & Chrysler  
24 Varieties - 149 Pieces

Contains the following Auveco Part Numbers:  
**8774, 8776, 11948, 14153, 14154 14462, 14880,  
14881, 14882, 14883, 14884, 14885, 14887,  
14888, 14889, 14892, 15497, 15498, 15499, 15504,  
15935, 16004, 20815 & 20816**

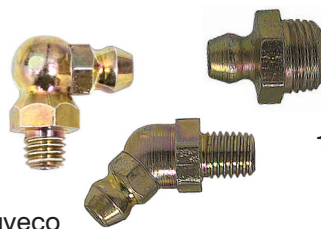

**6128 Fix-Kit**

Grease Fittings  
12 Varieties - 145 Pieces

| Auveco Part No. | Size      | Type                            |
|-----------------|-----------|---------------------------------|
| 9257            | 1/4" -28  | Thread, Straight (Short)        |
| 9258            | 1/4" -28  | Thread, Straight (Long)         |
| 9259            | 1/4" -28  | Thread, Straight (Extra Long)   |
| 9260            | 1/4" -28  | Thread, 45°                     |
| 9261            | 1/4" -28  | Thread, 90°                     |
| 9262            | 1/8" Pipe | Thread, Straight                |
| 9264            | 1/8" Pipe | Thread, 45°                     |
| 9265            | 1/8" Pipe | Thread, 65°-1/2                 |
| 9266            | 1/8" Pipe | Thread, 90°                     |
| 9267            | 1/8" Pipe | Thread, Straight (Extra Long)   |
| 15060           | 3/16"     | Drive Fit, Straight             |
| 15066           | 1/8" Pipe | Thread, Straight (Self-Tapping) |

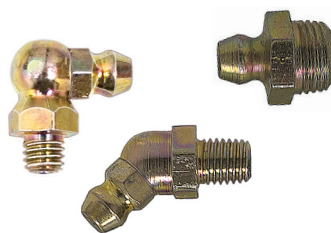

**6187 Fix-Kit**

Metric Grease Fittings  
12 Varieties - 165 Pieces

| Auveco Part No. | Size                |
|-----------------|---------------------|
| 11097           | 6mm-1.00, Straight  |
| 11775           | 6mm-1.00, 45°       |
| 11776           | 6mm-1.00, 90°       |
| 11098           | 8mm-1.00, Straight  |
| 11777           | 8mm-1.00, 45°       |
| 11099           | 8mm-1.00, 90°       |
| 11778           | 8mm-1.25, Straight  |
| 11779           | 8mm-1.25, 45°       |
| 11780           | 8mm-1.25, 90°       |
| 11100           | 10mm-1.00, Straight |
| 15067           | 10mm-1.00, 45°      |
| 11101           | 10mm-1.00, 90°      |

# "6000" SERIES SMALL DRAWER FIX-KITS

**Sec. 15**

*Photos not actual size*

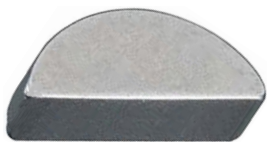

## 6065 Fix-Kit

Woodruff Keys  
1035 Carbon Steel  
20 Varieties - 383 Pieces

| Auveco Part No. | Size           | Key No. |
|-----------------|----------------|---------|
| 3877            | 1/8" x 1/2"    | No. 3   |
| 3878            | 1/8" x 5/8"    | No. 5   |
| 3879            | 1/8" x 3/4"    | No. 7   |
| 3880            | 3/32" x 5/8"   | No. 4   |
| 3881            | 5/32" x 5/8"   | No. 6   |
| 3882            | 5/32" x 3/4"   | No. 8   |
| 3883            | 5/32" x 7/8"   | No. 10  |
| 3884            | 3/16" x 3/4"   | No. 9   |
| 3885            | 3/16" x 7/8"   | No. 11  |
| 3886            | 3/16" x 1"     | No. 13  |
| 3887            | 3/16" x 1-1/8" | No. 16  |
| 3888            | 7/32" x 7/8"   | No. 12  |
| 3889            | 7/32" x 1"     | No. 14  |
| 3890            | 7/32" x 1-1/8" | No. 17  |
| 3891            | 1/4" x 7/8"    | No. A   |
| 3892            | 1/4" x 1"      | No. 15  |
| 3893            | 1/4" x 1-1/8"  | No. 18  |
| 3894            | 1/4" x 1-1/4"  | No. 21  |
| 3895            | 5/16" x 1"     | No. B   |
| 3896            | 5/16" x 1-1/8" | No. C   |

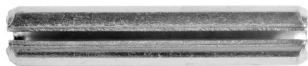

## 6125 Fix-Kit

Spring Pins  
Zinc Plated  
20 Varieties - 600 Pieces

| Auveco Part No. | Size           |
|-----------------|----------------|
| 9013            | 5/32" x 1/2"   |
| 9015            | 5/32" x 3/4"   |
| 9016            | 5/32" x 1"     |
| 9017            | 5/32" x 1-1/4" |
| 9018            | 5/32" x 1-1/2" |
| 9019            | 3/16" x 1/2"   |
| 9021            | 3/16" x 3/4"   |
| 9022            | 3/16" x 1"     |
| 9023            | 3/16" x 1-1/4" |
| 9024            | 3/16" x 1-1/2" |
| 9025            | 3/16" x 1-3/4" |
| 9026            | 3/16" x 2"     |
| 9030            | 1/4" x 5/8"    |
| 9031            | 1/4" x 3/4"    |
| 9033            | 1/4" x 1"      |
| 9034            | 1/4" x 1-1/4"  |
| 9035            | 1/4" x 1-1/2"  |
| 9036            | 1/4" x 1-3/4"  |
| 9037            | 1/4" x 2"      |
| 9038            | 1/4" x 2-1/4"  |

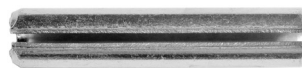

## 6124 Fix-Kit

Spring Pins  
Zinc Plated  
24 Varieties - 1475 Pieces

| Auveco Part No. | Size           |
|-----------------|----------------|
| 8981            | 1/16" x 3/16"  |
| 8983            | 1/16" x 1/2"   |
| 8985            | 1/16" x 3/4"   |
| 8987            | 1/16" x 1"     |
| 8988            | 5/64" x 1/4"   |
| 8989            | 5/64" x 1/2"   |
| 8991            | 5/64" x 3/4"   |
| 8992            | 5/64" x 1"     |
| 8993            | 5/64" x 1-1/4" |
| 8994            | 5/64" x 1-1/2" |
| 8995            | 3/32" x 5/16"  |
| 8996            | 3/32" x 1/2"   |
| 8998            | 3/32" x 3/4"   |
| 9000            | 3/32" x 1"     |
| 9001            | 3/32" x 1-1/4" |
| 9002            | 3/32" x 1-1/2" |
| 9003            | 1/8" x 3/8"    |
| 9004            | 1/8" x 1/2"    |
| 9006            | 1/8" x 3/4"    |
| 9008            | 1/8" x 1"      |
| 9009            | 1/8" x 1-1/4"  |
| 9010            | 1/8" x 1-1/2"  |
| 9011            | 1/8" x 1-3/4"  |
| 9012            | 1/8" x 2"      |

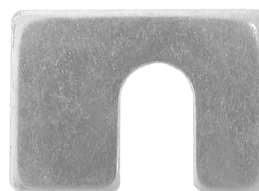

## 6166 Fix-Kit

Body and Fender Shims  
Zinc Plated  
4 Varieties - 400 Pieces

| Auveco Part No. | Size                          | Slot |
|-----------------|-------------------------------|------|
| 2452            | 1-3/4" x 1-1/4" x 1/16" Thick | 1/2" |
| 2453            | 1-3/4" x 1-1/4" x 1/8" Thick  | 1/2" |
| 3155            | 1-1/4" x 1-1/8" x 1/16" Thick | 3/8" |
| 3156            | 1-1/4" x 1-1/8" x 1/8" Thick  | 3/8" |



## 6162 Fix-Kit

"Xmas Tree" Retainers  
GM-Ford-Chrysler  
8 Varieties - 320 Pieces



Contains the following  
Auveco Part Numbers:

**10621, 11146, 11351, 11678, 11721,  
11797, 12137 & 12565**

*Photos not actual size*



**6062 Fix-Kit**  
 Plug Buttons  
 Nickel Plated  
 9 Varieties - 270 Pieces

| Auveco Part No. | Hole Size |
|-----------------|-----------|
| 3750            | 1/4"      |
| 3751            | 3/8"      |
| 3752            | 1/2"      |
| 3753            | 5/8"      |
| 3754            | 3/4"      |
| 3755            | 7/8"      |
| 3756            | 1"        |
| 10231           | 1-1/4"    |
| 10232           | 1-1/2"    |



**6133 Fix-Kit**  
 Steel Tubing Clamps  
 Vinyl Coated  
 Galvanized  
 8 Varieties - 200 Pieces

| Auveco Part No. | Tube Diameter | Hole Diameter | Width |
|-----------------|---------------|---------------|-------|
| 9381            | 1/4"          | 9/32"         | 1/2"  |
| 9382            | 5/16"         | 9/32"         | 1/2"  |
| 9383            | 3/8"          | 9/32"         | 1/2"  |
| 9384            | 1/2"          | 9/32"         | 1/2"  |
| 9385            | 5/8"          | 9/32"         | 1/2"  |
| 9386            | 3/4"          | 9/32"         | 1/2"  |
| 9387            | 7/8"          | 9/32"         | 1/2"  |
| 9388            | 1"            | 9/32"         | 1/2"  |



**6176 Fix-Kit**  
 Thread Repair Inserts & Installation Tool  
 12 Varieties - 40 Pieces

| Auveco Part No. | Internal Thread Size |
|-----------------|----------------------|
| 12374           | #10-24               |
| 12375           | #10-32               |
| 12376           | 1/4"-20              |
| 12377           | 1/4"-28              |
| 12378           | 5/16"-18             |
| 12379           | 5/16"-24             |
| 12380           | 3/8"-16              |
| 12381           | 3/8"-24              |
| 12382           | 7/16"-14             |
| 12383           | 7/16"-20             |
| 12384           | 1/2"-13              |
| 12385           | 1/2"-20              |
| 12404           | Installation Tools   |



**6168 Fix-Kit**  
 Hose Connectors  
 Barbed on all sides  
 8 Sizes - 155 Pieces

| Auveco Part No. | Size          |
|-----------------|---------------|
| 10101           | 1/8" x 1/8"   |
| 10102           | 3/16" x 3/16" |
| 10103           | 1/4" x 1/4"   |
| 10104           | 5/16" x 5/16" |
| 10105           | 3/8" x 3/8"   |
| 10106           | 1/4" x 3/16"  |
| 10107           | 3/8" x 1/4"   |
| 16961           | 1/2" x 1/2"   |

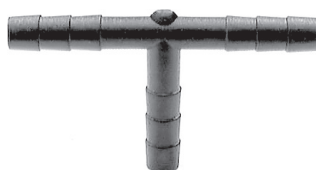

**6167 Fix-Kit**  
 Tee Connectors  
 Barbed on all sides  
 7 Sizes - 84 Pieces

| Auveco Part No. | Hose Size |
|-----------------|-----------|
| 10697           | 1/8"      |
| 10108           | 5/32"     |
| 10109           | 3/16"     |
| 10110           | 1/4"      |
| 14813           | 5/16"     |
| 11228           | 3/8"      |
| 11229           | 1/2"      |

**STAY UP TO DATE WITH US**

**For the most up to date information on all Auveco items, including new items, stock availability and online ordering please visit [www.auveco.com](http://www.auveco.com)**

# LARGE DRAWER FIX-KIT

Photos not actual size

Sec. 15

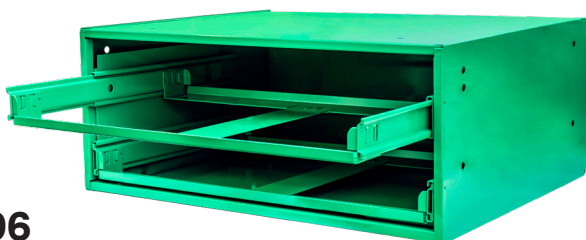

**3-96**

**Empty Cabinet.** Holds 2 Large Drawers.  
20" Wide x 15-3/4" Deep x 8" High  
Finish: Light Green Enamel  
Drawer Size: 18" Wide x 12" Deep x 3" High



**Empty Plastic Tray Inserts**

**1-916INSERT:** 16 Compartment for Drawer 1-916  
**1-920INSERT:** 20 Compartment for Drawer 1-920  
**1-924INSERT:** 24 Compartment for Drawer 1-924

UNIT PACKAGE: 1 case per insert  
Only available in Master Case of 4 - Not sold separately.



**4-96**

**Cabinet & 4 Empty Large Drawers**  
24 Compartment Drawers with Locking Latches  
20" Wide x 15-3/4" Deep x 14-1/2" High  
Finish: Light Green Enamel  
Drawer Size: 18" Wide x 12" Deep x 3" High



**1-900**  
Steel with Locking Latch

18 x 12 x 3  
Adjustable  
Compartment  
Empty Drawer with  
3 Vertical &  
3 Horizontal  
Dividers

UNIT PACKAGE: 1

**2-96**

**Empty Cabinet.** Holds 4 Large Drawers



**1-901**  
Steel with Locking Latch

18 x 12 x 3  
Adjustable  
Compartment  
Empty Drawer  
with 9 dividers

UNIT PACKAGE: 1



**B-3**

Base for 2-96,  
3-96 & 4-96  
Raises unit 15" off floor for easier bottom drawer use  
Finish: Light Green Enamel

UNIT PACKAGE: 1

## Empty Drawers

(18" Wide x 12" Deep x 3" High)  
With Locking Latches:  
**1-912:** 12 Compartment  
**1-916:** 16 Compartment  
**1-920:** 20 Compartment  
**1-924:** 24 Compartment  
**1-932:** 32 Compartment



**1-902**  
Steel with Locking Latch

18 x 12 x 3  
Adjustable  
Compartment  
Empty Drawer with  
6 fixed horizontal  
compartments and  
12 movable  
dividers adjustable  
on 1" centers.

UNIT PACKAGE: 1



*Photos not actual size*



Auveco offers more than 46 prepackaged Fix-Kits in the 6500 series large drawer.

Each drawer measures 18” wide x 12” deep x 3” high.

Each drawer’s compartment is designed to hold the entire contents of one or more standard Auveco unit packages.

Printed lid labels identify the correct Auveco part number for ordering refills.

**“6500” Series Large Drawer Fix-Kit Numeric Listing**

*Refer to contents listing on following pages*

| Auveco Part No. | Description                            |
|-----------------|--|
| 6501            | Phillips Oval Head Tapping Screws      |
| 6502            | Tubular, Flat, U & J-Nuts              |
| 6503            | Round Head Machine Screws & Nuts       |
| 6504            | Woodruff Keys                          |
| 6505            | O-Rings                                |
| 6506            | Cotter Pins                            |
| 6507            | Internal & External Retaining Rings    |
| 6508            | E-Rings                                |
| 6509            | Spring Pins                            |
| 6510            | Spring Pins                            |
| 6511            | Grease Fittings                        |
| 6513            | Metric Cap Screws & Nuts               |
| 6514            | Metric Cap Screws & Nuts               |
| 6517            | Nylon Nuts                             |
| 6519            | GM “Xmas Tree” Retainers               |
| 6520            | Ford “Xmas Tree” Retainers             |
| 6522            | “Xmas Tree” Retainers                  |
| 6523            | Tee Connectors & Rubber Caps           |
| 6524            | Well-Nuts® & Jack Nuts®                |
| 6525            | Nylon Rivets                           |
| 6530            | Phillips Washer Head Tapping Screws    |
| 6532            | Stainless Steel Screws, Nuts & Washers |
| 6533            | Stainless Steel Tapping Screws         |
| 6534            | Oil Drain Plugs                        |
| 6535            | Extension Springs                      |
| 6536            | Teks® Tapping Screws                   |

| Auveco Part No. | Description                                       |
|-----------------|---|
| 6537            | Door Hinge Pins & Bushings                        |
| 6538            | Cylinder Head & Manifold Studs                    |
| 6539            | Phillips Pan Head Machine Screws & Nuts           |
| 6540            | Metric Body Bolts & Nuts                          |
| 6541            | Small Size U.S.S. Grade 5 Cap Screws & Nuts       |
| 6542            | GM Ford & Chrysler Push-Type Retainers            |
| 6543            | O.E.M. Terminals & Tools                          |
| 6544            | Krimp & Seal Terminals                            |
| 6545            | GM Moulding Clips                                 |
| 6546            | Hyundai & Kia Clips & Fasteners                   |
| 6547            | Volkswagen & Audi Clips & Fasteners               |
| 6548            | Honda & Acura Retainers & Retaining Clips         |
| 6549            | Honda & Acura Push-Type Retainers                 |
| 6550            | Nissan & Infiniti Retainers & Push-Type Retainers |
| 6551            | Toyota & Lexus Retainers & Retaining Clips        |
| 6552            | Toyota & Lexus Push-Type Retainers                |
| 6553            | Oil Drain Plugs & Gaskets                         |
| 6554            | J.I.S. Hex Flange Bolts & Spin Lock Nuts          |
| 6555            | Mercedes-Benz Clips & Fasteners                   |
| 6556            | BMW Clips & Fasteners                             |
| 6557            | Metal Rivets                                      |
| 6558            | Cable Ties & Harness Straps                       |

**“6500” Series/ “6000” Series Kit Cross Reference**

*The 6600 Series Body Hardware Master Assortments are listed on pages 324-331*

| 6500 Kit | 6000 Kit |
|----------|----------|
| 6501     | 6003     |
| 6502     | 6007     |
| 6503     | 6011     |
| 6504     | 6065     |
| 6505     | 6085     |
| 6506     | 6112     |
| 6507     | 6116     |
| 6058     | 6123     |

| 6500 Kit | 6000 Kit |
|----------|----------|
| 6509     | 6124     |
| 6510     | 6125     |
| 6511     | 6128     |
| 6513     | 6160     |
| 6530     | 6182     |
| 6534     | 6186     |
| 6536     | 6144     |
| 6543     | 6178     |

# "6500" SERIES LARGE DRAWER FIX-KITS

*Photos not actual size*

**Sec. 15**



## 6501 Fix-Kit

Phillips Oval Head Tapping Screws  
Zinc & Chrome Plated  
24 Varieties - 540 Pieces

| Auveco Part No. | Size         | Head  |
|-----------------|--------------|-------|
| 3069            | #4 x 3/4"    |       |
| 1793            | #6 x 5/8"    |       |
| 1794            | #6 x 3/4"    |       |
| 1796            | #6 x 1"      |       |
| 1797            | #6 x 1-1/4"  |       |
| 2024            | #8 x 3/8"    | No.6  |
| 2358            | #8 x 1/2"    |       |
| 2027            | #8 x 1/2"    | No. 6 |
| 1421            | #8 x 5/8"    | No. 6 |
| 1799            | #8 x 3/4"    | No. 6 |
| 2359            | #8 x 3/4"    |       |
| 1801            | #8 x 1"      | No. 6 |
| 1802            | #8 x 1-1/8"  | No. 6 |
| 2361            | #8 x 1-1/4"  |       |
| 1803            | #8 x 1-1/4"  | No. 6 |
| 2362            | #8 x 1-1/2"  |       |
| 1932            | #8 x 1-1/2"  | No. 6 |
| 1933            | #8 x 1-3/4"  | No. 6 |
| 1717            | #10 x 3/4"   | No. 8 |
| 2728            | #10 x 3/4"   |       |
| 1804            | #10 x 1"     | No. 6 |
| 1807            | #10 x 1-1/8" |       |
| 2046            | #10 x 1-1/2" | No. 6 |
| 2665            | #10 x 2"     | No. 8 |



## 6530 Fix-Kit

Phillips Flat Top Washer  
Head Tapping Screws  
Black E-Coat Plated  
12 Varieties - 1790 Pieces

| Auveco Part No. | Size        | Plating      |
|-----------------|-------------|--------------|
| 12950           | #6 x 1/2"   | Black E-Coat |
| 12951           | #6 x 3/4"   | Black E-Coat |
| 12213           | #8 x 1/2"   | Black E-Coat |
| 12214           | #8 x 5/8"   | Black E-Coat |
| 12215           | #8 x 3/4"   | Black E-Coat |
| 12216           | #8 x 1"     | Black E-Coat |
| 12217           | #8 x 1-1/4" | Black E-Coat |
| 12218           | #8 x 1-1/2" | Black E-Coat |
| 12953           | #10 x 3/4"  | Black E-Coat |
| 12954           | #10 x 1"    | Black E-Coat |
| 14859           | #8 x 1/2"   | Zinc         |
| 14861           | #8 x 3/4"   | Zinc         |



## 6539 Fix-Kit

Phillips Pan Head  
Machine Screws & Nuts  
Zinc Plated  
12 Varieties of Screws  
4 Varieties of Nuts  
2160 Pieces

| Auveco Part No. | Size           |
|-----------------|----------------|
| <b>Hex Nut</b>  |                |
| 728             | #8-32          |
| 729             | #10-32         |
| 730             | #10-24         |
| 733             | 1/4"-20        |
| <b>Screw</b>    |                |
| 15381           | #8-32 x 1/2"   |
| 15382           | #8-32 x 3/4"   |
| 15383           | #8-32 x 1"     |
| 15387           | #10-24 x 1/2"  |
| 15388           | #10-24 x 3/4"  |
| 15389           | #10-24 x 1"    |
| 15393           | #10-32 x 1/2"  |
| 15394           | #10-32 x 3/4"  |
| 15395           | #10-32 x 1"    |
| 15398           | 1/4"-20 x 1/2" |
| 15399           | 1/4"-20 x 3/4" |
| 15400           | 1/4"-20 x 1"   |



## 6533 Fix-Kit

Stainless Steel Phillips Head  
Tapping Screws  
24 Varieties - 1600 Pieces

| Auveco Part No. | Size         | Head |
|-----------------|--------------|------|
| 9399            | #6 x 1/2"    | Oval |
| 9400            | #6 x 3/4"    | Oval |
| 9401            | #6 x 1"      | Oval |
| 9403            | #8 x 1/2"    | Oval |
| 9404            | #8 x 3/4"    | Oval |
| 9405            | #8 x 1"      | Oval |
| 9406            | #8 x 1-1/4"  | Oval |
| 9407            | #8 x 1-1/2"  | Oval |
| 9409            | #10 x 3/4"   | Oval |
| 9410            | #10 x 1"     | Oval |
| 9412            | #10 x 1-1/2" | Oval |
| 13265           | #6 x 1/2"    | Pan  |
| 13266           | #6 x 3/4"    | Pan  |
| 13267           | #6 x 1"      | Pan  |
| 13269           | #8 x 1/2"    | Pan  |
| 13270           | #8 x 3/4"    | Pan  |
| 13271           | #8 x 1"      | Pan  |
| 13272           | #8 x 1-1/4"  | Pan  |
| 13273           | #8 x 1-1/2"  | Pan  |
| 13274           | #10 x 1/2"   | Pan  |
| 13275           | #10 x 3/4"   | Pan  |
| 13276           | #10 x 1"     | Pan  |
| 13277           | #10 x 1-1/4" | Pan  |
| 13278           | #10 x 1-1/2" | Pan  |

*Photos not actual size*



**6503 Fix-Kit**

Slotted Round Head  
Machine Screws  
Zinc Plated  
19 Varieties of Screws  
5 Varieties of Nuts  
1110 Pieces

| Auveco Part No. | Size            |
|-----------------|-----------------|
| <b>Nut</b>      |                 |
| 727             | #6-32           |
| 728             | #8-32           |
| 729             | #10-32          |
| 730             | #10-24          |
| 731             | #12-24          |
| <b>Screw</b>    |                 |
| 2530            | #6-32 x 1/2"    |
| 2531            | #6-32 x 3/4"    |
| 2532            | #6-32 x 1"      |
| 2533            | #8-32 x 1/2"    |
| 2534            | #8-32 x 3/4"    |
| 2535            | #8-32 x 1"      |
| 2536            | #10-32 x 1/2"   |
| 2537            | #10-32 x 3/4"   |
| 2538            | #10-32 x 1"     |
| 2539            | #10-32 x 1-1/4" |
| 2540            | #10-32 x 1-1/2" |
| 2541            | #10-24 x 1/2"   |
| 2542            | #10-24 x 3/4"   |
| 2543            | #10-24 x 1"     |
| 2544            | #10-24 x 1-1/4" |
| 2545            | #10-24 x 1-1/2" |
| 2546            | #12-24 x 1/2"   |
| 2548            | #12-24 x 1"     |
| 2550            | #12-24 x 1-1/2" |

**6536 Fix-Kit**

Teks® Self-Drilling Screws  
Phillips Pan Head  
Hex Washer Head  
Zinc Plated  
16 Varieties - 365 Pieces



| Auveco Part No. | Size         | Head |
|-----------------|--------------|------|
| 9605            | #8 x 1/2"    | Pan  |
| 9606            | #8 x 3/4"    | Pan  |
| 9607            | #10 x 1/2"   | Pan  |
| 9608            | #10 x 3/4"   | Pan  |
| 11905           | #12 x 1"     | Pan  |
| 9611            | #8 x 1/2"    | Hex  |
| 9612            | #8 x 3/4"    | Hex  |
| 9613            | #10 x 1/2"   | Hex  |
| 9614            | #10 x 5/8"   | Hex  |
| 9615            | #10 x 3/4"   | Hex  |
| 9616            | #10 x 1"     | Hex  |
| 11911           | #12 x 1"     | Hex  |
| 9620            | #14 x 3/4"   | Hex  |
| 11914           | #14 x 1"     | Hex  |
| 11915           | #14 x 1-1/4" | Hex  |
| 11916           | #14 x 1-1/2" | Hex  |

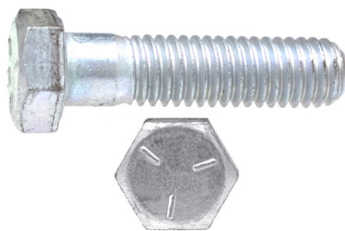

**6541 Fix-Kit**

U.S.S. Grade 5  
Cap Screws with Nuts  
Zinc Plated  
12 Varieties of Screws  
3 Varieties of Nuts  
540 Pieces

| Auveco Part No. | Size              |
|-----------------|-------------------|
| <b>Screw</b>    |                   |
| 5434            | 1/4"-20 x 1/2"    |
| 5436            | 1/4"-20 x 3/4"    |
| 5438            | 1/4"-20 x 1"      |
| 5440            | 1/4"-20 x 1-1/2"  |
| 5449            | 5/16"-18 x 3/4"   |
| 5451            | 5/16"-18 x 1"     |
| 5453            | 5/16"-18 x 1-1/2" |
| 5455            | 5/16"-18 x 2"     |
| 5465            | 3/8"-16 x 1"      |
| 5466            | 3/8"-16 x 1-1/4"  |
| 5467            | 3/8"-16 x 1-1/2"  |
| 5469            | 3/8"-16 x 2"      |
| <b>Hex Nut</b>  |                   |
| 15586           | 1/4"-20           |
| 15587           | 5/16"-18          |
| 15588           | 3/8"-16           |

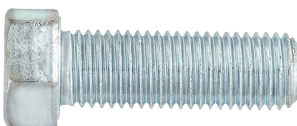

**6514 Fix-Kit**

DIN 931 & DIN 933  
Metric Regular Pitch  
Cap Screws & Nuts  
Zinc Plated  
15 Varieties - 128 Pieces

| Auveco Part No. | Size            |
|-----------------|-----------------|
| <b>Screw</b>    |                 |
| 14424           | M8-1.25 x 40mm  |
| 14425           | M8-1.25 x 45mm  |
| 14426           | M8-1.25 x 50mm  |
| 14431           | M10-1.50 x 25mm |
| 14432           | M10-1.50 x 30mm |
| 14433           | M10-1.50 x 35mm |
| 14434           | M10-1.50 x 40mm |
| 14436           | M10-1.50 x 50mm |
| 14440           | M12-1.75 x 25mm |
| 14441           | M12-1.75 x 30mm |
| 14442           | M12-1.75 x 35mm |
| 14443           | M12-1.75 x 40mm |
| <b>Nut</b>      |                 |
| 14452           | M8-1.25         |
| 14454           | M10-1.50        |
| 14455           | M12-1.75        |

# "6500" SERIES LARGE DRAWER FIX-KITS

Photos not actual size

**Sec. 15**



## 6540 Fix-Kit

Metric Body Bolts & Nuts  
10 Varieties of Bolts  
5 Varieties of Extruded U-Nuts  
3 Varieties of Free Spinning Washer Nuts  
2 Varieties of Hex Flange Nuts  
254 Pieces

| Auveco Part No. | Size            | Type                 |
|-----------------|-----------------|----------------------|
| 12693           | M6-1.0 x 20mm   | Bolt                 |
| 12324           | M6-1.0 x 20mm   | Bolt                 |
| 12160           | M6-1.0 x 22mm   | Bolt                 |
| 12065           | M6-1.0 x 25mm   | Bolt                 |
| 12066           | M6-1.0 x 25mm   | Bolt                 |
| 12335           | M6-1.0 x 28mm   | Bolt                 |
| 17388           | M8-1.25 x 20mm  | Bolt                 |
| 13613           | M8-1.25 x 25mm  | Bolt                 |
| 13614           | M8-1.25 x 30mm  | Bolt                 |
| 11641           | M10-1.50 x 40mm | Bolt                 |
| 11644           | M8-1.25         | Hex Flange Nut       |
| 11645           | M10-1.5         | Hex Flange Nut       |
| 12595           | M6-1.0          | Free Spin Washer Nut |
| 15329           | M6-1.0          | Free Spin Washer Nut |
| 15335           | M8-1.25         | Free Spin Washer Nut |
| 12669           | M6-1.0          | Extruded U-Nut       |
| 12575           | M6-1.0          | Extruded U-Nut       |
| 11630           | M8-1.25         | Extruded U-Nut       |
| 11629           | M8-1.25         | Extruded U-Nut       |
| 11631           | M10-1.5         | Extruded U-Nut       |

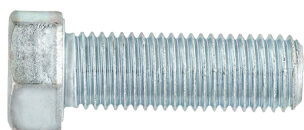

## 6513 Fix-Kit

DIN 933  
Metric Regular Pitch  
Cap Screws & Nuts  
Zinc Plated  
16 Varieties - 236 Pieces

| Auveco Part No. | Size           |
|-----------------|----------------|
| <b>Screws</b>   |                |
| 14400           | M4-.7 x 16mm   |
| 14401           | M4-.7 x 20mm   |
| 14402           | M5-.8 x 10mm   |
| 14403           | M5-.8 x 16mm   |
| 14404           | M5-.8 x 20mm   |
| 14405           | M5-.8 x 25mm   |
| 14408           | M6-1.0 x 16mm  |
| 14409           | M6-1.0 x 20mm  |
| 14410           | M6-.10 x 25mm  |
| 14420           | M8-1.25 x 20mm |
| 14421           | M8-1.25 x 25mm |
| 14422           | M8-1.25 x 30mm |
| <b>Nut</b>      |                |
| 14448           | M4-.7          |
| 14449           | M5-.8          |
| 14450           | M6-1.0         |
| 14452           | M8-1.25        |

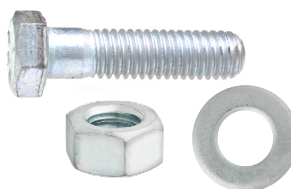

## 6532 Fix-Kit

Stainless Steel Cap Screws,  
Nuts & Washers  
24 Varieties - 660 Pieces

| Auveco Part No. | Size              | Type        |
|-----------------|-------------------|-------------|
| 13346           | 1/4"-20 x 1/2"    | Screw       |
| 13347           | 1/4"-20 x 3/4"    | Screw       |
| 13348           | 1/4"-20 x 1"      | Screw       |
| 13349           | 1/4"-20 x 1-1/4"  | Screw       |
| 13350           | 1/4"-20 x 1-1/2"  | Screw       |
| 13352           | 1/4"-20 x 2"      | Screw       |
| 13354           | 5/16"-18 x 3/4"   | Screw       |
| 13355           | 5/16"-18 x 1"     | Screw       |
| 13356           | 5/16"-18 x 1-1/4" | Screw       |
| 13357           | 5/16"-18 x 1-1/2" | Screw       |
| 13359           | 5/16"-18 x 2"     | Screw       |
| 13364           | 3/8"-16 x 1"      | Screw       |
| 13365           | 3/8"-16 x 1-1/4"  | Screw       |
| 13366           | 3/8"-16 x 1-1/2"  | Screw       |
| 13368           | 3/8"-16 x 2"      | Screw       |
| 13234           | 1/4"-20           | Hex Nut     |
| 13235           | 5/16"-18          | Hex Nut     |
| 13236           | 3/8"-16           | Hex Nut     |
| 13395           | Bolt Size: 1/4"   | Flat Washer |
| 13396           | Bolt Size: 5/16"  | Flat Washer |
| 13397           | Bolt Size: 3/8"   | Flat Washer |
| 13403           | Bolt Size: 1/4"   | Lock Washer |
| 13404           | Bolt Size: 5/16"  | Lock Washer |
| 13405           | Bolt Size: 3/8"   | Lock Washer |



## 6554 Fix-Kit

J.I.S. Hex Flange Bolts  
& Spin Lock Nuts  
21 Varieties - 322 Pieces

| Auveco Part No. | Size            |
|-----------------|-----------------|
| <b>Bolts</b>    |                 |
| 17315           | M6-1.0 x 12mm   |
| 17316           | M6-1.0 x 16mm   |
| 18807           | M6-1.0 x 20mm   |
| 21048           | M6-1.0 x 25mm   |
| 18808           | M6-1.0 x 30mm   |
| 18809           | M6-1.0 x 40mm   |
| 18980           | M8-1.25 x 12mm  |
| 17387           | M8-1.25 x 16mm  |
| 17388           | M8-1.25 x 20mm  |
| 21051           | M8-1.25 x 25mm  |
| 17389           | M8-1.25 x 30mm  |
| 21052           | M8-1.25 x 35mm  |
| 17390           | M8-1.25 x 40mm  |
| 21053           | M8-1.25 x 45mm  |
| 17188           | M10-1.25 x 16mm |
| 17189           | M10-1.25 x 20mm |
| 21054           | M10-1.25 x 25mm |
| 17190           | M10-1.25 x 30mm |
| 21055           | M10-1.25 x 35mm |
| 17191           | M10-1.25 x 40mm |
| 21056           | M10-1.25 x 45mm |
| <b>Nut</b>      |                 |
| 16769           | M6-1.0          |
| 16830           | M8-1.25         |
| 16470           | M10-1.25        |

*Photos not actual size*

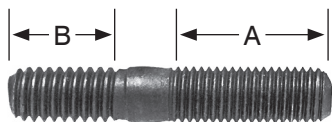

**6538 Fix-Kit**  
Cylinder Head & Manifold Studs  
24 Varieties - 120 Pieces

| Auveco Part No. | Dimensions<br>A B                                      |
|-----------------|--|
| 9667            | A: 1/4"-28 x 7/16"<br>B: 1/4"-20 x 7/16"               |
| 9669            | A: 1/4"-28 x 3/4"<br>B: 1/4"-20 x 1/2"                 |
| 9674            | A: 5/16"-24 x 5/8"<br>B: 5/16"-18 x 1/2"               |
| 9675            | A: 5/16"-24 x 5/8"<br>B: 5/16"-18 x 3/4"               |
| 9676            | A: 5/16"-24 x 7/8"<br>B: 5/16"-18 x 9/16"              |
| 9677            | A: 5/16"-24 x 1"<br>B: 5/16"-18 x 9/16"                |
| 9679            | A: 5/16"-18 x 7/8"<br>B: 5/16"-18 x 7/16"              |
| 9683            | A: 3/8"-24 x 3/4"<br>B: 3/8"-16 x 1/2"                 |
| 9684            | A: 3/8"-24 x 3/4"<br>B: 3/8"-16 x 1/2"                 |
| 9686            | A: 3/8"-24 x 1"<br>B: 3/8"-16 x 5/8"                   |
| 9687            | A: 3/8"-16 x 1-1/8"<br>B: 3/8"-16 x 5/8"               |
| 14827           | A: 3/8"-16 x 1-1/2"<br>B: 3/8"-16 x 7/16"              |
| 9689            | A: 3/8"-24 x 1"<br>B: 3/8"-16 x 3/4"                   |
| 9690            | A: 3/8"-24 x 2"<br>B: 3/8"-16 x 5/8"                   |
| 9699            | A: 7/16"-20 x 3/4"<br>B: 7/16"-14 x 9/16"              |
| 9701            | A: 7/16"-20 x 7/8"<br>B: 7/16"-14 x 3/4"               |
| 9705            | A: 7/16"-20 x 3/4"<br>B: 7/16"-14 x 3/4"               |
| 9711            | A: 7/16"-14 x 1-1/4"<br>B: 7/16"-14 x 3/4"             |
| 9715            | A: 7/16"-20 x 1-13/16"<br>B: 7/16"-14 x 3/4"           |
| 9728            | A: 1/2"-20 x 15/16"<br>B: 1/2"-13 x 13/16"             |
| 9731            | A: 1/2"-20 x 1"<br>B: 1/2"-13 x 3/4"                   |
| 9732            | A: 1/2"-20 x 2"<br>B: 1/2"-13 x 3/4"                   |
| 11982           | A: M8-1.25 x 22mm<br>B: M8-1.25 x 10mm<br>40mm Overall |
| 11983           | A: M8-1.25 x 22mm<br>B: M8-1.25 x 10mm<br>45mm Overall |



**6524 Fix-Kit**  
Special Purpose  
Well Nuts® & Jack Nuts®  
(O.E.M. Application)  
GM, Ford, Chrysler & AMC  
12 Varieties - 170 Pieces



Contains the following Auveco Part Numbers:  
12995, 12999, 13004, 13007, 13008, 13009, 13010,  
13014, 13016, 13017, 13231 & 16253



**6502 Fix-Kit**  
Tubular, Flat, U & J-Nuts  
24 Varieties - 515 Pieces

| Auveco Part No. | Size       | Type     |
|-----------------|------------|----------|
| 1903            | 1/4"-20    | Flat     |
| 2089            | #6-32      | Flat     |
| 2092            | #10-24     | Flat     |
| 2099            | 1/8" Stud  | Flat     |
| 2103            | 3/16" Stud | Flat     |
| 2105            | 1/4" Stud  | Flat     |
| 2293            | 1/4"-20    | U-Nut    |
| 2346            | #8         | J-Nut    |
| 2422            | #10        | U-Nut    |
| 2595            | 1/8" Stud  | Tubular  |
| 2611            | 1/8" Stud  | Tubular  |
| 5170            | 3/8"-16    | J Cage   |
| 5197            | #10-24     | U-Nut    |
| 5586            | 1/4"-20    | J Cage   |
| 5589            | 5/16"-18   | J Cage   |
| 9879            | #8         | Spring U |
| 9880            | #8         | Spring U |
| 10064           | #6         | Spring U |
| 10065           | #8         | Spring U |
| 10066           | #10        | Spring U |
| 10067           | #14        | Spring U |
| 10666           | #8         | U-Nut    |
| 11292           | #8         | U-Nut    |
| 11429           | #10        | U-Nut    |



**6507 Fix-Kit**  
Basic Internal & External  
Retaining Rings  
Zinc Plated  
24 Varieties - 1000 Pieces



| Auveco Part No.      | Shaft Diameter |
|----------------------|----------------|
| <b>Internal Type</b> |                |
| 8688                 | 1/4"           |
| 8689                 | 5/16"          |
| 8690                 | 3/8"           |
| 8691                 | 7/16"          |
| 8692                 | 1/2"           |
| 8693                 | 9/16"          |
| 8694                 | 5/8"           |
| 8695                 | 3/4"           |
| 8696                 | 7/8"           |
| 8697                 | 1"             |
| 8698                 | 1-1/8"         |
| 8699                 | 1-1/4"         |
| <b>External Type</b> |                |
| 8701                 | 1/4"           |
| 8702                 | 5/16"          |
| 8703                 | 3/8"           |
| 8704                 | 7/16"          |
| 8705                 | 1/2"           |
| 8706                 | 9/16"          |
| 8707                 | 5/8"           |
| 8708                 | 3/4"           |
| 8709                 | 7/8"           |
| 8710                 | 1"             |
| 8711                 | 1-1/8"         |
| 8712                 | 1-1/4"         |

# "6500" SERIES LARGE DRAWER FIX-KITS

*Photos not actual size*

**Sec. 15**



## 6508 Fix-Kit

E & Reinforced E-Rings  
Groove Required  
24 Varieties - 1500 Pieces



| Auveco Part No. | Shaft Diameter | Type         |
|-----------------|----------------|--------------|
| 8824            | 1/16"          | E-Type       |
| 8825            | 3/32"          | E-Type       |
| 8836            | 3/32"          | Reinforced E |
| 3165            | 1/8"           | Reinforced E |
| 8826            | 1/8"           | E-Type       |
| 3166            | 3/16"          | Reinforced E |
| 8827            | 3/16"          | E-Type       |
| 3167            | 1/4"           | Reinforced E |
| 8828            | 1/4"           | E-Type       |
| 3628            | 5/16"          | Reinforced E |
| 3824            | 5/16"          | E-Type       |
| 5600            | 3/8"           | Reinforced E |
| 8829            | 3/8"           | E-Type       |
| 2672            | 7/16"          | Reinforced E |
| 8830            | 7/16"          | E-Type       |
| 8837            | 1/2"           | Reinforced E |
| 5602            | 1/2"           | E-Type       |
| 5601            | 9/16"          | Reinforced E |
| 5603            | 5/8"           | E-Type       |
| 8831            | 3/4"           | E-Type       |
| 8832            | 7/8"           | E-Type       |
| 8833            | 1"             | E-Type       |
| 8834            | 1-3/16"        | E-Type       |
| 8835            | 1-3/8"         | E-Type       |

## 6535 Fix-Kit

Extension & Compression Springs  
12 Varieties - 94 Pieces

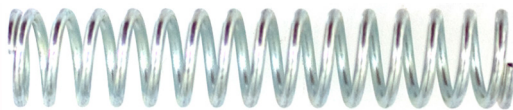

| Auveco Part No. | Length   |
|-----------------|----------|
| 14074           | 1-1/4"   |
| 14072           | 1-7/16"  |
| 14096           | 2-1/2"   |
| 14070           | 2-21/32" |
| 14063           | 3-1/4"   |
| 14064           | 4"       |
| 14067           | 4"       |
| 14066           | 4-1/16"  |
| 14065           | 4-1/2"   |
| 14068           | 5-1/4"   |
| 14059           | 6-7/16"  |
| 14060           | 6-1/2"   |

## 6506 Fix-Kit

Hammer-lock Cotter Pins  
Bright Zinc Chromate  
16 Varieties - 1500 Pieces



| Auveco Part No. | Size           |
|-----------------|----------------|
| 8477            | 1/16" x 1/2"   |
| 8478            | 1/16" x 3/4"   |
| 8479            | 1/16" x 1"     |
| 8480            | 1/16" x 1-1/2" |
| 8481            | 3/32" x 3/4"   |
| 8482            | 3/32" x 1"     |
| 8484            | 3/32" x 1-1/2" |
| 8485            | 3/32" x 2"     |
| 8486            | 1/8" x 1"      |
| 8487            | 1/8" x 1-1/4"  |
| 8488            | 1/8" x 1-1/2"  |
| 8490            | 1/8" x 2"      |
| 8491            | 1/8" x 2-1/2"  |
| 8492            | 5/32" x 1"     |
| 8493            | 5/32" x 1-1/2" |
| 8494            | 5/32" x 2"     |



## 6504 Fix-Kit

Woodruff Keys  
1035 Carbon Steel  
20 Varieties - 383 Pieces

| Auveco Part No. | Size           | Key No. |
|-----------------|----------------|---------|
| 3877            | 1/8" x 1/2"    | No. 3   |
| 3878            | 1/8" x 5/8"    | No. 5   |
| 3879            | 1/8" x 3/4"    | No. 7   |
| 3880            | 3/32" x 5/8"   | No. 4   |
| 3881            | 5/32" x 5/8"   | No. 6   |
| 3882            | 5/32" x 3/4"   | No. 8   |
| 3883            | 5/32" x 7/8"   | No. 10  |
| 3884            | 3/16" x 3/4"   | No. 9   |
| 3885            | 3/16" x 7/8"   | No. 11  |
| 3886            | 3/16" x 1"     | No. 13  |
| 3887            | 3/16" x 1-1/8" | No. 16  |
| 3888            | 7/32" x 7/8"   | No. 12  |
| 3889            | 7/32" x 1"     | No. 14  |
| 3890            | 7/32" x 1-1/8" | No. 17  |
| 3891            | 1/4" x 7/8"    | No. A   |
| 3892            | 1/4" x 1"      | No. 15  |
| 3893            | 1/4" x 1-1/8"  | No. 18  |
| 3894            | 1/4" x 1-1/4"  | No. 21  |
| 3895            | 5/16" x 1"     | No. B   |
| 3896            | 5/16" x 1-1/8" | No. C   |

*Photos not actual size*

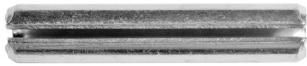

**6510 Fix-Kit**  
Spring Pins  
Zinc Plated  
20 Varieties - 600 Pieces

| Auveco Part No. | Size           |
|-----------------|----------------|
| 9013            | 5/32" x 1/2"   |
| 9015            | 5/32" x 3/4"   |
| 9016            | 5/32" x 1"     |
| 9017            | 5/32" x 1-1/4" |
| 9018            | 5/32" x 1-1/2" |
| 9019            | 3/16" x 1/2"   |
| 9021            | 3/16" x 3/4"   |
| 9022            | 3/16" x 1"     |
| 9023            | 3/16" x 1-1/4" |
| 9024            | 3/16" x 1-1/2" |
| 9025            | 3/16" x 1-3/4" |
| 9026            | 3/16" x 2"     |
| 9030            | 1/4" x 5/8"    |
| 9031            | 1/4" x 3/4"    |
| 9033            | 1/4" x 1"      |
| 9034            | 1/4" x 1-1/4"  |
| 9035            | 1/4" x 1-1/2"  |
| 9036            | 1/4" x 1-3/4"  |
| 9037            | 1/4" x 2"      |
| 9038            | 1/4" x 2-1/4"  |

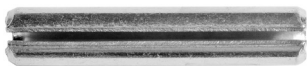

**6509 Fix-Kit**  
Spring Pins  
Zinc Plated  
24 Varieties - 1475 Pieces

| Auveco Part No. | Size           |
|-----------------|----------------|
| 8981            | 1/16" x 3/16"  |
| 8983            | 1/16" x 1/2"   |
| 8985            | 1/16" x 3/4"   |
| 8987            | 1/16" x 1"     |
| 8988            | 5/64" x 1/4"   |
| 8989            | 5/64" x 1/2"   |
| 8991            | 5/64" x 3/4"   |
| 8992            | 5/64" x 1"     |
| 8993            | 5/64" x 1-1/4" |
| 8994            | 5/64" x 1-1/2" |
| 8995            | 3/32" x 5/16"  |
| 8996            | 3/32" x 1/2"   |
| 8998            | 3/32" x 3/4"   |
| 9000            | 3/32" x 1"     |
| 9001            | 3/32" x 1-1/4" |
| 9002            | 3/32" x 1-1/2" |
| 9003            | 1/8" x 3/8"    |
| 9004            | 1/8" x 1/2"    |
| 9006            | 1/8" x 3/4"    |
| 9008            | 1/8" x 1"      |
| 9009            | 1/8" x 1-1/4"  |
| 9010            | 1/8" x 1-1/2"  |
| 9011            | 1/8" x 1-3/4"  |
| 9012            | 1/8" x 2"      |

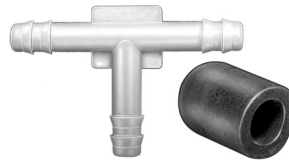

**6523 Fix-Kit**  
Nylon Connectors &  
Rubber Caps  
24 Varieties - 320 Sizes

| Auveco Part No.         | Size                  | Type     |
|-------------------------|-----------------------|----------|
| <b>Nylon Connectors</b> |                       |          |
| 12929                   | 1/8" x 1/8"           | Straight |
| 12930                   | 1/8" x 3/16"          | Straight |
| 12936                   | 1/8" x 1/4"           | Straight |
| 12937                   | 3/16" x 3/16"         | Straight |
| 12935                   | 1/4" x 3/16"          | Straight |
| 12931                   | 1/4" x 1/4"           | Straight |
| 12946                   | 5/16" x 5/16"         | Straight |
| 12923                   | 1/8" x 1/8" x 1/8"    | Tee      |
| 12916                   | 1/8" x 1/8" x 3/16"   | Tee      |
| 12926                   | 3/16" x 1/8" x 3/16"  | Tee      |
| 12918                   | 3/16" x 3/16" x 3/16" | Tee      |
| 12919                   | 1/4" x 3/16" x 3/16"  | Tee      |
| 11738                   | 1/4" x 3/16" x 1/4"   | Tee      |
| 12921                   | 3/8" x 1/4" x 3/8"    | Tee      |
| 12920                   | 5/16" x 5/16" x 5/16" | Tee      |
| 12927                   | 3/16" x 3/16" x 3/16" | Y        |
| 12943                   | 1/4" x 1/4" x 1/4"    | Y        |
| 12932                   | 3/16" x 3/16"         | Elbow    |
| 12939                   | 3/16"                 | Cross    |
| <b>Rubber Caps</b>      |                       |          |
| 12209                   | For 1/8" O.D. Tube    |          |
| 4440                    | For 3/16" O.D. Tube   |          |
| 4439                    | For 1/4" O.D. Tube    |          |
| 12907                   | For 5/16" O.D. Tube   |          |
| 12210                   | For 3/8" O.D. Tube    |          |

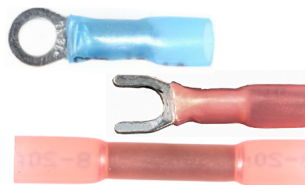

**6544 Fix-Kit**  
Krimp & Seal Terminals  
Featuring 3 - 1 Ratio  
Heat Shrink Tubing  
24 Varieties - 204 Pieces

| Auveco Part No. | Description              |
|-----------------|--------------------------|
| 13656           | Ring Type, 22-18 Gauge   |
| 13657           | Ring Type, 22-18 Gauge   |
| 13658           | Spade Type, 22-18 Gauge  |
| 13659           | Butt Conn., 22-18 Gauge  |
| 13660           | Female Q.C. 22-18 Gauge  |
| 13661           | Male Q.C., 22-18 Gauge   |
| 13662           | Ring Type, 16-14 Gauge   |
| 13663           | Ring Type, 16-14 Gauge   |
| 13664           | Ring Type, 16-14 Gauge   |
| 13665           | Ring Type, 16-14 Gauge   |
| 13666           | Ring Type, 16-14 Gauge   |
| 13669           | Butt Conn., 16-14 Gauge  |
| 13670           | Female Q.C., 16-14 Gauge |
| 13671           | Male Q.C., 16-14 Gauge   |
| 13672           | Female Q.C., 16-14 Gauge |
| 13673           | Male, Q.C., 16-14 Gauge  |
| 13674           | Ring Type, 12-10 Gauge   |
| 13675           | Ring Type, 12-10 Gauge   |
| 13676           | Ring Type, 12-10 Gauge   |
| 13678           | Butt Conn., 12-10 Gauge  |
| 13679           | Female Q.C., 12-10 Gauge |
| 13680           | Male Q.C., 12-10 Gauge   |
| 13681           | Female Plug, 16-14 Gauge |
| 13682           | Male Plug, 16-14 Gauge   |

# "6500" SERIES LARGE DRAWER FIX-KITS

*Photos not actual size*

**Sec. 15**

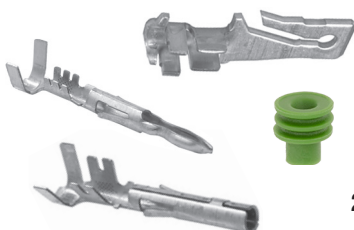

## 6543 Fix-Kit

O.E.M. Electrical  
Terminals & Tools  
GM, Ford & Chrysler  
24 Varieties - 263 Pieces

Contains the following Auveco Part Numbers:  
**8774, 8776, 14150, 14151, 14152, 14462, 14880,  
14881, 14883, 14884, 14885, 14892, 15497, 15498,  
15499, 15504, 15937, 15948, 15955, 18324,  
18325, 18326, 20583 & 20618**



## 6558 Fix-Kit

Cable Ties & Straps  
10 Varieties - 339 Pieces

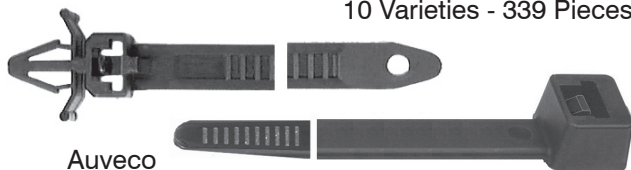

Auveco  
Part No.

Size

| Auveco Part No. | Size                    |
|-----------------|-------------------------|
| <b>8550</b>     | 2-1/4" Long, 7/16" Wide |
| <b>14298</b>    | 140mm Long, 8mm Wide    |
| <b>15144</b>    | 4" Long, 3/32" Wide     |
| <b>15145</b>    | 5-1/2" Long, 1/8" Wide  |
| <b>15146</b>    | 7" Long, 3/16" Wide     |
| <b>15147</b>    | 11" Long, 3/16" Wide    |
| <b>15148</b>    | 14" Long, 5/16" Wide    |
| <b>15753</b>    | 14" Long, 3/16" Wide    |
| <b>20380</b>    | 200mm Long, 5mm Wide    |
| <b>21203</b>    | 155mm Long, 5mm Wide    |



## 6534 Fix-Kit

Oil Drain Plugs & Gaskets  
12 Varieties - 86 Pieces

Auveco  
Part No.

Size

| Auveco Part No. | Size                    |
|-----------------|-------------------------|
| <b>14196</b>    | 1/2"-20                 |
| <b>18373</b>    | 1/2"-20                 |
| <b>18121</b>    | 1/2"-20 Double Oversize |
| <b>15527</b>    | M12-1.25                |
| <b>14677</b>    | M12-1.75                |
| <b>18374</b>    | M12-1.75                |
| <b>21047</b>    | M12-1.75                |
| <b>14678</b>    | M14-1.5                 |
| <b>16308</b>    | M14-1.5                 |
| <b>19279</b>    | M14-1.5                 |
| <b>19773</b>    | M14-1.5                 |
| <b>15529</b>    | M18-1.5                 |



## 6553 Fix-Kit

Oil Drain Plugs &  
Gaskets  
24 Varieties  
55 Pieces

Auveco  
Part No.

Size

| Auveco Part No. | Size                    |
|-----------------|-------------------------|
| <b>14196</b>    | 1/2"-20                 |
| <b>18373</b>    | 1/2"-20                 |
| <b>19130</b>    | 1/2"-20                 |
| <b>19365</b>    | 1/2"-20, Magnetic       |
| <b>15527</b>    | M12-1.25                |
| <b>19588</b>    | M12-1.25                |
| <b>14677</b>    | M12-1.75                |
| <b>18023</b>    | M12-1.75                |
| <b>18374</b>    | M12-1.75                |
| <b>20347</b>    | M12-1.75                |
| <b>21047</b>    | M12-1.75                |
| <b>18024</b>    | M14-1.25                |
| <b>14678</b>    | M14-1.5                 |
| <b>16308</b>    | M14-1.5                 |
| <b>18025</b>    | M14-1.5                 |
| <b>18375</b>    | M14-1.5                 |
| <b>19141</b>    | M14-1.5                 |
| <b>19279</b>    | M14-1.5                 |
| <b>19620</b>    | M14-1.5 Single Oversize |
| <b>19773</b>    | M14-1.5                 |
| <b>20426</b>    | M14-1.5                 |
| <b>15528</b>    | M16.4-1.33              |
| <b>15529</b>    | M18-1.5                 |
| <b>15530</b>    | M20-1.5                 |



## 6511 Fix-Kit

Grease Fittings  
12 Varieties - 145 Pieces

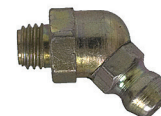

Auveco  
Part No.

Type

| Auveco Part No. | Type                                    |
|-----------------|---|
| <b>9257</b>     | 1/4" - 28 Thread, Straight (Short)      |
| <b>9258</b>     | 1/4" - 28 Thread, Straight (Long)       |
| <b>9259</b>     | 1/4" - 28 Thread, Straight (Extra Long) |
| <b>9260</b>     | 1/4" - 28 Thread - 45°                  |
| <b>9261</b>     | 1/4" - 28 Thread - 90°                  |
| <b>9262</b>     | 1/8" Pipe Thread - Straight             |
| <b>9264</b>     | 1/8" Pipe Thread - 45°                  |
| <b>9265</b>     | 1/8" Pipe Thread - 65°                  |
| <b>9266</b>     | 1/8" Pipe Thread - 90°                  |
| <b>9267</b>     | 1/8" Pipe Thread, Straight (Extra Long) |
| <b>15060</b>    | 3/16" Drive Fit, Straight               |
| <b>15066</b>    | 1/8" Pipe, Straight (Self-Tapping)      |



*Photos not actual size*



**6525 Fix-Kit**

Black Nylon Blind Rivets  
16 Varieties - 400 Pieces

| Auveco Part No. | Diameter | Grip          |
|-----------------|----------|---------------|
| 13746           | 3/16"    | 1/16"-9/64"   |
| 13747           | 13/64"   | 1/16"-11/64"  |
| 14005           | 13/64"   | 1/8"-5/32"    |
| 13748           | 13/64"   | 1/8"-15/64"   |
| 13755           | 13/64"   | 15/64"-25/64" |
| 14004           | 15/64"   | 11/64"-11/32" |
| 14023           | 15/64"   | 5/32"-5/16"   |
| 18502           | 1/4"     | 5/32"-1/4"    |
| 18108           | 1/4"     | 5/32"-3/8"    |
| 13751           | 1/4"     | 5/32"-13/32"  |
| 13750           | 1/4"     | 5/32"-13/32"  |
| 15491           | 1/4"     | 19/64"-27/64" |
| 17101           | 1/4"     | 5/16"-15/32"  |
| 13752           | 17/64"   | 3/32"-3/16"   |
| 13753           | 17/64"   | 3/32"-3/16"   |
| 15490           | 9/32"    | 3/32"-15/64"  |



**6557 Fix-Kit**

Metal Specialty Rivets  
24 Varieties - 624 Pieces

| Auveco Part No.               | Grip            |
|-------------------------------|-----------------|
| <b>1/8" (3.2mm) Diameter</b>  |                 |
| 20788                         | 3/64" - 1/8"    |
| 20627                         | 3/64" - 3/16"   |
| 16834                         | 1/8" - 3/16"    |
| 8931                          | 3/16" - 1/4"    |
| 17615                         | 3/16" - 3/8"    |
| <b>5/32" (4mm) Diameter</b>   |                 |
| 18461                         | 3/64" - 1/4"    |
| 20629                         | 3/64" - 1/4"    |
| 20971                         | 3/64" - 9/32"   |
| 19376                         | 1/8" - 11/32"   |
| 17006                         | 1/4" - 3/8"     |
| <b>3/16" (4.8mm) Diameter</b> |                 |
| 16864                         | 3/64" - 11/32"  |
| 20741                         | 3/64" - 23/64"  |
| 17121                         | 5/64" - 15/64"  |
| 8311                          | 1/8" - 1/4"     |
| 17410                         | 3/8" - 1/2"     |
| 14127                         | 3/8" - 1/2"     |
| <b>1/4" (6.4mm) Diameter</b>  |                 |
| 16837                         | 1/32" - 9/64"   |
| 12653                         | 3/32" - 1/8"    |
| 18167                         | 3/32" - 9/64"   |
| 12652                         | 1/8" - 1/4"     |
| 12655                         | 9/64" - 3/16"   |
| 17639                         | 3/16" - 3/8"    |
| 8313                          | 1/4" - 3/8"     |
| 16838                         | 33/64" - 19/32" |



**6505 Fix-Kit**

Rubber O-Rings  
20 Varieties - 300 Pieces

| Auveco Part No. | Inner Diameter | Outer Diameter |
|-----------------|----------------|----------------|
| 4305            | 1/8"           | 1/4"           |
| 4306            | 5/32"          | 9/32"          |
| 4307            | 3/16"          | 5/16"          |
| 4308            | 7/32"          | 11/32"         |
| 4309            | 1/4"           | 3/8"           |
| 4310            | 5/16"          | 7/16"          |
| 4311            | 3/8"           | 1/2"           |
| 4312            | 3/8"           | 9/16"          |
| 4313            | 7/16"          | 5/8"           |
| 4314            | 1/2"           | 11/16"         |
| 4315            | 9/16"          | 3/4"           |
| 4316            | 5/8"           | 13/16"         |
| 4317            | 11/16"         | 7/8"           |
| 4318            | 3/4"           | 15/16"         |
| 4319            | 3/4"           | 1"             |
| 4320            | 13/16"         | 1-1/16"        |
| 4321            | 7/8"           | 1-1/8"         |
| 4322            | 15/16"         | 1-3/16"        |
| 4323            | 1"             | 1-1/4"         |
| 4324            | 1-1/16"        | 1-5/16"        |

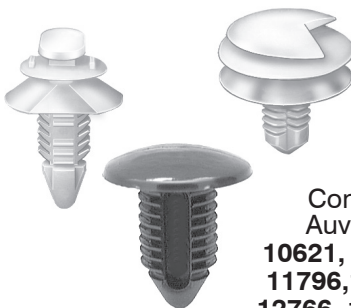

**6519 Fix-Kit**

"Xmas Tree" Retainers  
GM  
12 Varieties - 500 Pieces

Contains the following  
Auveco Part Numbers:

**10621, 10831, 11146, 11678,  
11796, 12137, 12731, 12737,  
12766, 15970, 16818 & 17664**



**6522 Fix-Kit**

"Xmas Tree" Retainers  
GM, Ford & Chrysler  
12 Varieties - 550 Pieces

Contains the following  
Auveco Part Numbers:

**10831, 11146, 11796, 12137,  
12565, 12737, 12766, 12909,  
16818, 17339, 17612 & 17664**



**6520 Fix-Kit**

"Xmas Tree" Retainers  
Ford  
12 Varieties - 465 Pieces

Contains the following  
Auveco Part Numbers:

**10831, 11136, 11146, 11351,  
11671, 12565, 12571, 12909,  
14757, 17339, 17664 & 20192**

# "6500" SERIES LARGE DRAWER FIX-KITS

Photos not actual size

**Sec. 15**

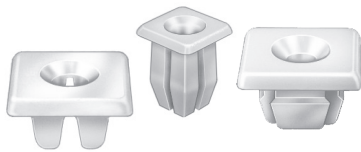

## 6517 Fix-Kit

Nylon Nuts  
16 Varieties - 850 Pieces

Contains the following Auveco Part Numbers:  
2625, 3682, 5228, 8435, 9829, 9851, 9862,  
10330, 11368, 11691, 11719, 11838, 11855,  
13450, 13933 & 18816

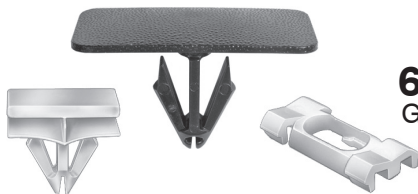

## 6545 Fix-Kit

GM Moulding Clips  
24 Varieties  
234 Pieces

Contains the following Auveco Part Numbers:  
10617, 14642, 19757, 19800, 19820, 19821, 19822,  
20280, 20318, 20328, 20353, 20377, 20607, 20756,  
20774, 20808, 20865, 20884, 20934, 20952,  
20972, 20976, 21128 & 21374

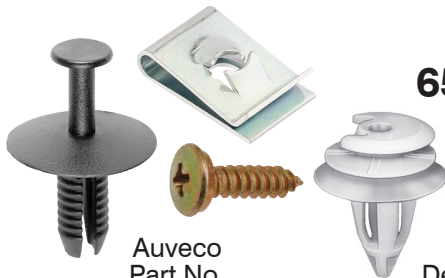

## 6556 Fix-Kit

BMW Clips &  
Fasteners  
14 Varieties  
416 Pieces

Auveco  
Part No.

Description

|       |                                |
|-------|--------------------------------|
| 13158 | Moulding Clip                  |
| 13162 | U-Nut                          |
| 13215 | U-Nut                          |
| 13216 | U-Nut                          |
| 13218 | U-Nut                          |
| 13223 | U-Nut                          |
| 18156 | M4.8-1.59 x 16mm<br>L.P. Screw |
| 20186 | Grommet                        |
| 20234 | Push-Type Retainer             |
| 20248 | Push-Type Retainer             |
| 20253 | Trim Panel Retainer            |
| 20270 | Push-Type Retainer             |
| 20734 | Push-Type Retainer             |
| 20754 | Nylon Rivet                    |



## 6542 Fix-Kit

GM, Ford & Chrysler  
Push-Type Retainers  
11 Varieties - 325 Pieces

Contains the following  
Auveco Part Numbers:

20826, 20880, 20888, 20889, 20988, 20989,  
20990, 20991, 20992, 20993 & 20994



## 6548 Fix-Kit

Honda & Acura  
Retainers & Retaining Clips  
24 Varieties - 404 Pieces

Contains the following Auveco part numbers:  
14289, 14291, 14328, 15998, 16775, 16776, 16779,  
17205, 18114, 18294, 18746, 18877, 19114, 19116,  
19145, 19171, 19470, 19506, 19682, 20334,  
20609, 20610, 20882 & 21107



## 6549 Fix-Kit

Honda & Acura  
Push-Type Retainers  
24 Varieties - 254 Pieces

Contains the following  
Auveco part numbers:  
14696, 14697, 16000, 16782, 17057,  
17143, 17144, 17267, 17379, 18119, 19118,  
19140, 19231, 19233, 19239, 19416, 19453, 20247,  
20352, 20564, 20608, 20986, 21173 & 21297

## 6537 Fix-Kit

Door Hinge Pins & Bushings  
15 Varieties - 221 Pieces



Bushings

14548, 14549, 14550, 14551,  
14552, 14553, 16936, 16937, 17167 & 17434



Pins

14559, 19183, 19424 & 19781



## 6546 Fix-Kit

Hyundai & Kia  
Clips & Fasteners  
20 Varieties  
375 Pieces

Auveco  
Part No.

Description

|       |                             |
|-------|-----------------------------|
| 20543 | Hood Insulation Retainer    |
| 20566 | Moulding Clip               |
| 20567 | Moulding Clip               |
| 20568 | Moulding Clip               |
| 20680 | M6-1.0 L.P. Screw           |
| 21064 | Moulding Clip               |
| 21067 | Bumper & Grille Retainer    |
| 21068 | Nylon Nut                   |
| 21070 | Trim Panel Retainer         |
| 21136 | Moulding Clip               |
| 21146 | Push-Type Retainer          |
| 21188 | Trim Panel Retainer         |
| 21244 | Moulding Clip               |
| 21312 | Moulding Clip               |
| 21321 | Moulding Clip               |
| 21328 | Push-Type Retainer          |
| 21360 | Trim Panel Retainer         |
| 21378 | Nylon U-Nut                 |
| 21381 | Hood Seal Retainer          |
| 21382 | Cowl Vent & Grille Retainer |

*Photos not actual size*



**6555 Fix-Kit**

Mercedes-Benz  
Clips & Fasteners  
24 Varieties - 488 Pieces

| Auveco Part No. | Description              |
|-----------------|--------------------------|
| 13215           | U-Nut                    |
| 13216           | U-Nut                    |
| 13218           | U-Nut                    |
| 13220           | U-Nut                    |
| 13223           | U-Nut                    |
| 13224           | U-Nut                    |
| 13230           | Push-Type Retainer       |
| 16124           | Tubular Type Nut         |
| 20187           | Push-Type Retainer       |
| 20188           | Trim Panel Retainer      |
| 20203           | Push-Type Retainer       |
| 20205           | Moulding Insert          |
| 20314           | Push-Type Retainer       |
| 20636           | Push-Type Retainer       |
| 20637           | Push-Type Retainer       |
| 20638           | Push-Type Retainer       |
| 20642           | Door Panel Retainer Clip |
| 20645           | Carpet Retainer          |
| 20650           | U-Nut                    |
| 20735           | Door Panel Retainer      |
| 20897           | Moulding Clip            |
| 20909           | Push-Type Retainer       |
| 20971           | Rivet                    |
| 21105           | Hood Insulation Retainer |



**6550 Fix-Kit**

Nissan & Infiniti  
Retainers &  
Push-Type Retainers  
24 Varieties - 369 Pieces

Contains the following  
Auveco part numbers:

14355, 14696, 14737, 16000, 16776, 16782, 16784,  
16858, 16859, 17237, 17347, 17452, 17472, 18166,  
18948, 19246, 19274, 19684, 20327, 20348,  
20349, 20672, 20953 & 21192



**6551 Fix-Kit**

Toyota & Lexus  
Retainers  
& Retaining Clips  
24 Varieties - 361 Pieces

Contains the following  
Auveco part numbers:

14269, 14736, 14737, 14738, 15709, 18297, 18692,  
18842, 18844, 18876, 18878, 19112, 19113, 19210,  
19257, 19729, 19749, 19842, 20437, 20443,  
20633, 20757, 20758 & 21102



**6552 Fix-Kit**

Toyota & Lexus  
Push-Type Retainers  
24 Varieties - 229 Pieces

Contains the following  
Auveco part numbers:

14260, 16784, 17162, 17439,  
18270, 18873, 18888, 19140, 19416, 19552,  
19739, 20335, 20349, 20577, 20869, 20908, 20931,  
20955, 21010, 21011, 21103, 21123, 21201 & 21294



**6547 Fix-Kit**

Volkswagen & Audi  
Clips &  
Fasteners  
24 Varieties  
385 Pieces

| Auveco Part No. | Description                 |
|-----------------|-----------------------------|
| 13173           | Door Panel Clip             |
| 13475           | Trim Panel Retainer         |
| 17006           | Moulding Rivet              |
| 19195           | Push-Type Retainer          |
| 20341           | Trim Panel Retainer         |
| 20924           | Screw Grommet               |
| 20925           | Screw Grommet               |
| 21144           | Trim Panel Retainer         |
| 21145           | Hood Insulation Retainer    |
| 21251           | Push-Type Retainer          |
| 21392           | Cowl Vent & Grille Retainer |
| 21393           | Trim Retainer               |
| 21394           | Moulding Clip               |
| 21395           | Moulding Clip               |
| 21396           | Moulding Clip               |
| 21397           | Moulding Clip Grommet       |
| 21398           | Trim Panel Retainer         |
| 21399           | Screw Grommet               |
| 21449           | Moulding Clip               |
| 21478           | Moulding Clip               |
| 21479           | Push-Type Retainer          |
| 21512           | Moulding Clip               |
| 21513           | Push-On Retainer            |
| 21515           | Fender & Bumper Retainer    |

*Photos not actual size*



## A Great Marketing Concept for New or Existing Accounts

Looking to provide more variety of coverage and be sure that there is enough product to finish the job, Quik-Select II is your answer.

Auveco's Quik-Select II features a polypropylene box that's larger than our 6800 series Quik-Select assortments. It also has a larger variety of parts in each assortment and a greater number of each part per compartment.

The assortments come in 12, 18 and 24 compartment, translucent, durable polypropylene boxes. Box lid labels have O.E.M. numbers, sizes, product pictures, code 128 barcodes and Auveco part numbers for ordering refills.

## "6900" Series Quik-Select II Numeric Listing

*Refer to contents listing on following pages*

| Auveco Part No. | Description                                   |
|-----------------|---|
| 6901            | GM Retainers                                  |
| 6902            | Ford Retainers                                |
| 6903            | Chrysler Retainers                            |
| 6904            | GM Push-Type Retainers                        |
| 6905            | Ford Push-Type Retainers                      |
| 6906            | Chrysler Push-Type Retainers                  |
| 6907            | GM Nylon Nuts                                 |
| 6908            | Ford Nylon Nuts                               |
| 6910            | Toyota & Lexus Retainers & Retaining Clips    |
| 6911            | Honda & Acura Retainers & Retaining Clips     |
| 6912            | Nissan & Infiniti Retainers & Retaining Clips |
| 6913            | Toyota & Lexus Push-Type Retainers            |
| 6914            | Honda & Acura Push-Type Retainers             |
| 6915            | Nissan & Infiniti Push-Type Retainers         |
| 6916            | Toyota & Lexus Nylon Nuts & Screw Grommets    |
| 6917            | Honda & Acura Nylon Nuts & Screw Grommets     |
| 6918            | Nissan & Infiniti Nylon Nuts & Screw Grommets |

| Auveco Part No. | Description  |
|-----------------|--|
| 6919            | GM, Ford & Chrysler Push-Type Retainers                            |
| 6920            | Black Tapping Screws   |
| 6921            | Teks® Screws   |
| 6923            | Extruded U-Nuts  |
| 6924            | Washer Lock Nuts, Thread Cutting Nuts, Push-On & Pushnut Retainers |
| 6929            | Rubber & Vinyl Vacuum Caps   |
| 6930            | Nylon Connectors   |
| 6931            | Oil Drain Plug Gaskets   |
| 6933            | Rubber Grommets  |
| 6934            | Door Lock Rod Clips  |
| 6935            | BMW Clips & Fasteners  |
| 6936            | Mercedes-Benz Clips & Fasteners                                    |
| 6937            | Hyundai & Kia Clips & Fasteners                                    |
| 6938            | Weatherstrip & Trim Panel Retainers                                |
| 6939            | Rocker Panel & Moulding Clips                                      |
| 6940            | Asian Bumper Retainers   |
| 6941            | Import Fender Retainers  |
| 6942            | Ford F-150 Clips & Fasteners                                       |

## Empty Compartment Boxes

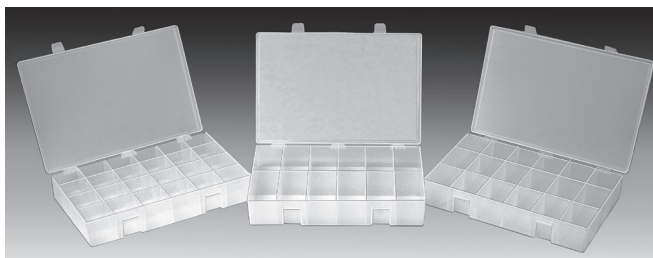

Translucent Durable Polypropylene Boxes with Locking Tabs  
13-1/16" Wide x 8-13/16" Deep x 2-1/4" High

### 12 Compartment Box

69-12: UNIT PACKAGE: 1  
69-112: UNIT PACKAGE: 10

### 18 Compartment Box

69-18: UNIT PACKAGE: 1  
69-118: UNIT PACKAGE: 10

### 24 Compartment Box

69-24: UNIT PACKAGE: 1  
69-124: UNIT PACKAGE: 10

## Quik-Select II Rack



### 69-RACK

Empty Cabinet: Holds 5 Quik-Select II Assortments.  
13-1/2" Wide x 9-1/8" Deep x 13-1/4" High

Finish: Gray Enamel

Keyhole slots are furnished for wall mounting.  
A handle is provided and bolt holes permits stacking.

UNIT PACKAGE: 1

*Photos not actual size*



**6920**  
Black Tapping Screws  
24 Varieties - 490 Pieces

Auveco  
Part No.

Size

**Black Oxide Phillips Oval Head**

|       |                      |
|-------|----------------------|
| 12897 | #4 x 1"              |
| 12796 | #6 x 3/4"            |
| 10162 | #8 x 1/2" with #6 HD |
| 10164 | #8 x 3/4" with #6 HD |
| 10165 | #8 x 3/4"            |
| 10166 | #8 x 1" with #6 HD   |
| 10167 | #8 x 1"              |

**Black Oxide Phillips Pan Head**

|       |             |
|-------|-------------|
| 11917 | #6 x 1/2"   |
| 10180 | #8 x 1/2"   |
| 10181 | #8 x 3/4"   |
| 10182 | #8 x 1"     |
| 12799 | #8 x 1-1/2" |
| 11921 | #10 x 1/2"  |
| 11922 | #10 x 3/4"  |
| 11923 | #10 x 1"    |

**Black E-Coat Phillips Flat Washer Head**

|       |             |
|-------|-------------|
| 12213 | #8 x 1/2"   |
| 12214 | #8 x 5/8"   |
| 12215 | #8 x 3/4"   |
| 12216 | #8 x 1"     |
| 12217 | #8 x 1-1/4" |
| 12218 | #8 x 1-1/2" |
| 12953 | #10 x 3/4"  |
| 12954 | #10 x 1"    |

**Black Phosphate Phillips Pan Head Sems®**

|       |           |
|-------|-----------|
| 12820 | #8 x 3/4" |
|-------|-----------|



**6923**  
Extruded U-Nuts  
18 Varieties - 125 Pieces

Auveco  
Part No.

Size

Center of  
Hole to Edge

|       |          |        |
|-------|----------|--------|
| 10048 | #8-32    | 3/8"   |
| 15677 | #10-24   | 15/32" |
| 8359  | 1/4"-20  | 17/32" |
| 10051 | 1/4"-20  | 25/32" |
| 10053 | 5/16"-18 | 9/16"  |
| 8814  | 5/16"-18 | 27/32" |
| 10054 | 3/8"-16  | 3/4"   |
| 10055 | 3/8"-16  | 1-1/8" |
| 11625 | M4-7     | 13.5mm |
| 11626 | M5-8     | 15.8mm |
| 16846 | M6-1.0   | 12mm   |
| 16842 | M6-1.0   | 13.5mm |
| 12669 | M6-1.0   | 13.5mm |
| 12575 | M6-1.0   | 19.5mm |
| 11628 | M6.3-1.0 | 13.5mm |
| 11629 | M8-1.25  | 14.5mm |
| 11630 | M8-1.25  | 20mm   |
| 11631 | M10-1.5  | 19mm   |



**6921**  
Teks® Screws  
18 Varieties - 520 Pieces



Auveco  
Part No.

Size

**Phillips Pan Head**

|      |            |
|------|------------|
| 9605 | #8 x 1/2"  |
| 9606 | #8 x 3/4"  |
| 9608 | #10 x 3/4" |

**Hex Washer Head**

|       |            |
|-------|------------|
| 9611  | #8 x 1/2"  |
| 9612  | #8 x 3/4"  |
| 9613  | #10 x 1/2" |
| 9615  | #10 x 3/4" |
| 9616  | #10 x 1"   |
| 11911 | #12 x 1"   |
| 11914 | #14 x 1"   |

**Specialty Screws**

|       |                  |
|-------|------------------|
| 12095 | #8 x 1/2"        |
| 15172 | #8 x 1/2"        |
| 15774 | #8 x 1/2"        |
| 17460 | #8 x 3/4"        |
| 17650 | #8 x 3/4"        |
| 18261 | M4.2-1.41 x 16mm |
| 15775 | M4.2-1.41 x 20mm |
| 19006 | M4.2-1.41 x 25mm |



**6929**  
Vacuum Caps  
12 Varieties - 332 Pieces

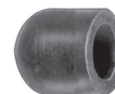

Auveco  
Part No.

Size

**Rubber Vacuum Caps**

|       |                      |
|-------|----------------------|
| 12209 | Fits 1/8" O.D. Tube  |
| 4440  | Fits 3/16" O.D. Tube |
| 4439  | Fits 1/4" O.D. Tube  |
| 19001 | Fits 1/4" O.D. Tube  |
| 12907 | Fits 5/16" O.D. Tube |
| 19002 | Fits 5/16" O.D. Tube |
| 12210 | Fits 3/8" O.D. Tube  |
| 12908 | Fits 1/2" O.D. Tube  |

**Vinyl Vacuum Caps**

|       |                      |
|-------|----------------------|
| 18202 | Fits 3/16" O.D. Tube |
| 18203 | Fits 1/4" O.D. Tube  |
| 18204 | Fits 5/16" O.D. Tube |
| 18205 | Fits 3/8" O.D. Tube  |

# "6900" SERIES QUIK-SELECT II ASSORTMENTS

**Sec. 15**

*Photos not actual size*

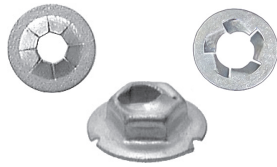

**6924**  
Washer Lock Nuts,  
Thread Cutting Nuts,  
Push-On Retainers &  
Pushnut Bolt Retainers  
24 Varieties - 489 Pieces

| Auveco Part No.               | Size               |
|-------------------------------|--------------------|
| <b>Thread Cutting Nuts</b>    |                    |
| 12253                         | 5mm Stud Size      |
| 3403                          | 1/8" Stud Size     |
| 3404                          | 3/16" Stud Size    |
| 2896                          | 3/16" Stud Size    |
| 2897                          | 1/4" Stud Size     |
| 3405                          | 1/4" Stud Size     |
| 10733                         | 5/16" Stud Size    |
| <b>Washer Lock Nuts</b>       |                    |
| 2557                          | #10-24 1/2 O.D.    |
| 2558                          | #10-24 3/4 O.D.    |
| <b>Push-On Retainers</b>      |                    |
| 8863                          | 1/8" Stud Size     |
| 8864                          | 5/32" Stud Size    |
| 8865                          | 3/16" Stud Size    |
| 8868                          | 1/4" Stud Size     |
| 8869                          | 5/16" Stud Size    |
| 10374                         | 3/8" Stud Size     |
| <b>Pushnut Bolt Retainers</b> |                    |
| 10086                         | 1/4" Bolt Size     |
| 10087                         | 5/16" Bolt Size    |
| 9297                          | 3/8" Bolt Size     |
| 9299                          | 1/2" Bolt Size     |
| 12122                         | M5-.8 Bolt Size    |
| 12123                         | M6-1.0 Bolt Size   |
| 12125                         | M8-1.25 Bolt Size  |
| 12127                         | M12-1.75 Bolt Size |
| 14980                         | M14-2.0 Bolt Size  |



**6931**  
Oil Drain Plug Gaskets  
18 Varieties  
153 Pieces



| Auveco Part No. | Size  | Type           |
|-----------------|-------|----------------|
| 8277            | 1/2"  | Nylon          |
| 15918           | 1/2"  | Copper         |
| 15919           | 9/16" | Copper         |
| 16026           | 1/2"  | Steel & Rubber |
| 16682           | 14mm  | Black Fibre    |
| 16955           | 18mm  | Aluminum       |
| 16956           | 14mm  | Aluminum       |
| 16996           | 1/2"  | Nylon          |
| 17261           | 12mm  | Copper         |
| 17262           | 14mm  | Copper         |
| 17264           | 18mm  | Copper         |
| 17265           | 20mm  | Copper         |
| 18299           | 14mm  | Steel & Rubber |
| 18665           | 11mm  | Rubber         |
| 18726           | 12mm  | Black Fibre    |
| 19601           | 12mm  | Aluminum       |
| 19630           | 11mm  | Rubber         |
| 20453           | 13mm  | Rubber         |

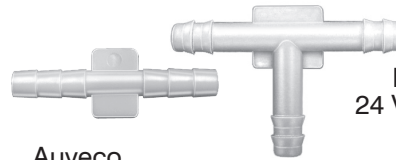

**6930**  
Nylon Connectors  
24 Varieties - 215 Pieces

| Auveco Part No. | Size                  | Type     |
|-----------------|-----------------------|----------|
| 10101           | 1/8" x 1/8"           | Straight |
| 12929           | 1/8" x 1/8"           | Straight |
| 12930           | 1/8" x 3/16"          | Straight |
| 12936           | 1/8" x 1/4"           | Straight |
| 10102           | 3/16" x 3/16"         | Straight |
| 12937           | 3/16" x 3/16"         | Straight |
| 10103           | 1/4" x 1/4"           | Straight |
| 12935           | 3/16" x 1/4"          | Straight |
| 12931           | 1/4" x 1/4"           | Straight |
| 10104           | 5/16" x 5/16"         | Straight |
| 12946           | 5/16" x 5/16"         | Straight |
| 10105           | 3/8" x 3/8"           | Straight |
| 12923           | 1/8" x 1/8" x 1/8"    | Tee      |
| 10108           | 5/32" x 5/32" x 5/32" | Tee      |
| 12926           | 3/16" x 1/8" x 3/16"  | Tee      |
| 10109           | 3/16" x 3/16" x 3/16" | Tee      |
| 12918           | 3/16" x 3/16" x 3/16" | Tee      |
| 12919           | 1/4" x 3/16" x 3/16"  | Tee      |
| 10110           | 1/4" x 1/4" x 1/4"    | Tee      |
| 12921           | 3/8" x 1/4" x 3/8"    | Tee      |
| 12920           | 5/16" x 5/16" x 5/16" | Tee      |
| 11228           | 3/8" x 3/8" x 3/8"    | Tee      |
| 12927           | 3/16" x 3/16" x 3/16" | Y        |
| 12932           | 3/16" x 3/16"         | Elbow    |



**6933**  
Rubber Grommets  
24 Varieties - 252 Pieces

| Auveco Part No. | Bore Diameter | Width |
|-----------------|---------------|-------|
| 4408            | 1/8"          | 3/32" |
| 4410            | 5/32"         | 1/16" |
| 4413            | 3/16"         | 1/16" |
| 4414            | 3/16"         | 3/32" |
| 4415            | 3/16"         | 1/4"  |
| 16454           | 1/4"          | 1/16" |
| 4417            | 1/4"          | 1/16" |
| 4419            | 5/16"         | 1/16" |
| 4420            | 5/16"         | 1/16" |
| 4421            | 5/16"         | 1/8"  |
| 4422            | 5/16"         | 1/4"  |
| 4423            | 3/8"          | 1/16" |
| 16456           | 3/8"          | 1/16" |
| 4425            | 3/8"          | 1/16" |
| 4426            | 3/8"          | 1/4"  |
| 4428            | 1/2"          | 3/32" |
| 4429            | 1/2"          | 3/32" |
| 16458           | 1/2"          | 1/8"  |
| 4430            | 1/2"          | 1/4"  |
| 4431            | 5/8"          | 1/8"  |
| 4432            | 5/8"          | 1/16" |
| 4433            | 3/4"          | 1/16" |
| 4434            | 3/4"          | 1/16" |
| 4436            | 3/4"          | 1/4"  |

*Photos not actual size*



**6901**

GM Retainers  
18 Varieties - 373 Pieces

Contains the following  
Auveco part numbers:

**10831, 11130, 11146, 11612, 11796, 12137,  
12731, 12737, 12759, 12766, 12992, 14036, 15456,  
15543, 15970, 16818, 17664 & 17975**



**6904**

GM Push-Type Retainers  
18 Varieties - 233 Pieces

Contains the following  
Auveco part numbers:

**12567, 12757, 13993, 13994, 13996,  
14010, 14011, 14020, 14753, 14997, 15044,  
16622, 16835, 17216, 17222, 18353, 19639 & 19801**



**6902**

Ford Retainers  
18 Varieties - 350 Pieces

Contains the following  
Auveco part numbers:

**10831, 11136, 11146, 11351,  
11612, 11671, 12565, 12571,  
12909, 13470, 14021, 14163, 15479,  
17339, 17612, 17664, 19655 & 20192**



**6903**

Chrysler Retainers  
18 Varieties - 338 Pieces

Contains the following  
Auveco part numbers:

**10831, 11129, 11136, 11146, 11351, 11678,  
14921, 15481, 15543, 16818, 17004, 17612,  
17664, 17975, 18033, 18862, 18915 & 19386**



**6905**

Ford Push-Type Retainers  
12 Varieties - 219 Pieces

Contains the following  
Auveco part numbers:

**13994, 14018, 14019, 14020,  
14753, 14953, 14991, 14992,  
14994, 17103, 17216 & 18894**



**6906**

Chrysler Push-Type Retainers  
12 Varieties - 205 Pieces

Contains the following  
Auveco part numbers:

**11699, 11704, 12567, 13993,  
14016, 14019, 14992, 16835,  
17216, 18030, 18269 & 19422**



**6919**

GM, Ford & Chrysler  
Push-Type Retainers  
11 Varieties - 215 Pieces

Contains the following  
Auveco part numbers:

**20826, 20880, 20888, 20889,  
20988, 20989, 20990, 20991,  
20992, 20993 & 20994**



**6942**

Ford F-150 (Aluminum Body)  
Clips & Fasteners  
17 Varieties - 167 Pieces



Contains the following  
Auveco part numbers:

**11146, 17664, 19338, 19801, 20530, 20766,  
20880, 20889, 21169, 21286, 21703, 22023,  
22058, 22066, 22067, 22154 & 22180**



**6934**

Door Lock Rod Clips  
18 Varieties - 152 Pieces



Contains the following Auveco part numbers:  
**10262, 14359, 14365, 14967, 15518, 15673, 15674,  
15675, 15759, 17122, 18392, 18393, 18926, 19658,  
20469, 20470, 20534 & 20535**



**6914**

Honda & Acura  
Push-Type Retainers  
18 Varieties - 163 Pieces



Contains the following  
Auveco part numbers:

**14696, 14697, 14698, 16000, 16782,  
17057, 17143, 17144, 17267, 17379, 18119,  
19118, 19140, 19233, 19239, 19453, 20247 & 20564**



**6907**

GM Nylon Nuts  
12 Varieties - 480 Pieces



Contains the following Auveco part numbers:  
**3682, 8435, 9829, 11424, 11691, 11719, 11838,  
12735, 13450, 13933, 13960 & 14031**

# "6900" SERIES QUIK-SELECT II ASSORTMENTS

*Photos not actual size*

**Sec. 15**



**6935**  
BMW Clips & Fasteners  
12 Varieties  
212 Pieces

| Auveco Part No. | Description                        |
|-----------------|------------------------------------|
| 13158           | Moulding Clip                      |
| 13162           | U-Nut                              |
| 13215           | U-Nut                              |
| 13218           | U-Nut                              |
| 13223           | U-Nut                              |
| 18156           | License Plate Screw<br>M4.8 X 16mm |
| 20234           | Nylon Rivet                        |
| 20248           | Push -Type Retainer                |
| 20253           | Trim Panel Retainer                |
| 20270           | Push -Type Retainer                |
| 20734           | Push -Type Retainer                |
| 20754           | Nylon Rivet                        |



**6917**  
Honda & Acura  
Nylon Nuts & Screw Grommets  
12 Varieties - 224 Pieces



Contains the following Auveco part numbers:  
**14255, 14268, 14274, 14281, 14288, 14313, 14695,  
17058, 18415, 19454, 19734 & 19741**



**6908**  
Ford Nylon Nuts  
12 Varieties - 310 Pieces



Contains the following Auveco part numbers:  
**9862, 11368, 11841, 12569, 14754, 14755, 14756,  
18816, 19277, 19326, 19783 & 20245**



**6911**  
Honda & Acura  
Retainers & Retaining Clips  
24 Varieties - 334 Pieces



Contains the following Auveco part numbers:  
**14282, 14289, 14291, 14328, 15998, 16775, 16776,  
16779, 17205, 18114, 18294, 18746, 18818, 18877,  
19114, 19116, 19145, 19171, 19470, 19483,  
19506, 19682, 20334 & 20609**



**6937**  
Hyundai & Kia  
Clips & Fasteners  
18 Varieties  
114 Pieces

| Auveco Part No. | Description                 |
|-----------------|-----------------------------|
| 20543           | Hood Insulation Retainer    |
| 20566           | Moulding Clip               |
| 20567           | Moulding Clip               |
| 20568           | Moulding Clip               |
| 20680           | M6-1.0 L. P. Screw          |
| 21064           | Moulding Clip               |
| 21067           | Bumper & Grille Retainer    |
| 21068           | Nylon Nut                   |
| 21070           | Trim Panel Retainer         |
| 21136           | Moulding Clip               |
| 21146           | Push-Type Retainer          |
| 21188           | Trim Panel Retainer         |
| 21244           | Moulding Clip               |
| 21312           | Moulding Clip               |
| 21321           | Moulding Clip               |
| 21328           | Push-Type Retainer          |
| 21378           | Nylon U-Nut                 |
| 21382           | Cowl Vent & Grille Retainer |



Auveco Part No.

**6936**  
Mercedes-Benz  
Clips & Fasteners  
24 Varieties  
106 Pieces



Description

|       |                          |
|-------|--------------------------|
| 13215 | U-Nut                    |
| 13216 | U-Nut                    |
| 13218 | U-Nut                    |
| 13220 | U-Nut                    |
| 13223 | U-Nut                    |
| 13224 | U-Nut                    |
| 13230 | Push-Type Retainer       |
| 16124 | Tubular Type Nut         |
| 20187 | Push-Type Retainer       |
| 20188 | Trim Panel Retainer      |
| 20203 | Push-Type Retainer       |
| 20205 | Moulding Insert          |
| 20314 | Push-Type Retainer       |
| 20636 | Push-Type Retainer       |
| 20637 | Push-Type Retainer       |
| 20638 | Push-Type Retainer       |
| 20642 | Door Panel Retainer Clip |
| 20645 | Carpet Retainer          |
| 20650 | U-Nut                    |
| 20735 | Door Panel Retainer      |
| 20897 | Moulding Clip            |
| 20909 | Push-Type Retainer       |
| 20971 | Rivet                    |
| 21105 | Hood Insulation Retainer |



*Photos not actual size*



**6910**

Toyota & Lexus  
Retainers & Retaining Clips  
24 Varieties - 280 Pieces

Contains the following Auveco part numbers:  
14144, 14269, 14270, 14736, 14737, 14738, 15707,  
15709, 16779, 18297, 18692, 18842, 18844, 18876,  
18878, 19112, 19113, 19124, 19210, 19257,  
19729, 19749, 19842 & 20443



**6938**

Weatherstrip &  
Trim Panel Retainers  
23 Varieties - 315 Pieces

Contains the following Auveco part numbers:  
11796, 12565, 12992, 14269, 14328, 14921, 17669,  
18033, 18353, 18848, 18877, 19171, 19386, 19850,  
20563, 21102, 21334, 21705, 21707, 21795,  
21822, 22027 & 22107



**6912**

Nissan & Infiniti  
Retainers & Retaining Clips  
12 Varieties - 335 Pieces

Contains the following Auveco part numbers:  
14349, 14352, 14353, 14355, 14356, 14723,  
14737, 16775, 16776, 17237, 17452 & 18166



**6939**

Rocker Panel &  
Moulding Clips  
23 Varieties  
171 Pieces

Contains the following Auveco part numbers:  
15695, 17612, 19820, 19821, 19822, 20318, 20353,  
20568, 20607, 20756, 20757, 20774, 20865, 20926,  
21158, 21226, 21241, 21244, 21285, 21683,  
21793, 22015 & 22068



**6913**

Toyota & Lexus  
Push-Type Retainers  
18 Varieties - 149 Pieces

Contains the following Auveco part numbers:  
14260, 16784, 17162, 17206, 17439, 17988, 17992,  
18270, 18873, 18888, 18939, 19013, 19128,  
19140, 19219, 19416, 19739 & 20335



**6940**

Asian Bumper Retainers  
24 Varieties - 179 Pieces

Contains the following Auveco part numbers:  
17206, 18119, 18873, 19233,  
19246, 19470, 20184, 20349, 20564, 20608, 20878,  
20931, 20953, 20986, 21173, 21682, 21706, 21836,  
21856, 22042, 22077, 22096, 22125 & 22160



**6918**

Nissan & Infiniti  
Nylon Nuts & Screw Grommets  
12 Varieties - 235 Pieces

Contains the following Auveco part numbers:  
13930, 13931, 14274, 14275, 14313, 14331, 14335,  
14695, 14724, 17196, 17342 & 19293



**6941**

Import Fender Retainers  
24 Varieties - 199 Pieces

Contains the following Auveco part numbers:  
16000, 17379, 17385, 19118, 19239, 19721, 20390,  
20391, 20429, 20688, 20757, 20764, 20869, 20954,  
21017, 21111, 21685, 21687, 21706, 21780,  
22014, 22017, 22054 & 22141



**6916**

Toyota & Lexus  
Nylon Nuts & Screw Grommets  
18 Varieties - 230 Pieces

Contains the following Auveco part numbers:  
13932, 14256, 14258, 14265, 14267, 14268, 14271,  
14273, 14274, 14275, 14277, 14281, 14695,  
19194, 19721, 19756, 19783 & 20440

# "6800" SERIES QUIK-SELECT ASSORTMENTS

**Sec. 15**



*Photos not actual size*

Fast moving body hardware and specialty fasteners in convenient, translucent, durable polypropylene boxes.

Our Quik-Select Assortments offer popular coverage in an economical package that makes choosing the correct part fast and easy.

Assortments come in 6, 12 and 18 compartment layouts complete with O.E.M. numbers, sizes, specifications and the proper Auveco part number for ordering refills.

## "6800" Series Quik-Select Numeric Listing

*Refer to contents listing on following pages*

| Auveco Part No. | Description                          | Auveco Part No. | Description                                   | Auveco Part No. | Description                             |
|-----------------|--------------------------------------|-----------------|---|-----------------|---|
| 6801            | GM "Xmas Tree" Retainers             | 6826            | Rubber Vacuum Caps                            | 6852            | Stainless Steel Tapping Screws          |
| 6802            | Ford "Xmas Tree" Retainers           | 6827            | Rubber Grommets                               | 6853            | Specialty Screws                        |
| 6803            | Chrysler "Xmas Tree" Retainers       | 6829            | Honda Body Hardware                           | 6854            | Metric Specialty Screws                 |
| 6804            | GM Push-Type Retainers               | 6830            | Hair Pin Cotter                               | 6856            | External & Internal Lock Washers        |
| 6805            | Ford Push-Type Retainers             | 6831            | Plastic Plug Buttons                          | 6857            | Thread Cutting & Washer Lock Nuts       |
| 6806            | Nylon Rivets                         | 6834            | Toyota Body Hardware                          | 6858            | Pushnut Bolt Retainers                  |
| 6807            | Nylon Nuts                           | 6835            | Rubber O-Rings                                | 6859            | Hose Connectors                         |
| 6808            | License Plate Hardware               | 6836            | Nylon Connectors                              | 6861            | Spring Pins                             |
| 6809            | Window Reveal Moulding Clips         | 6837            | Honda Body Hardware                           | 6862            | E-Type Retaining Rings                  |
| 6810            | Sems® Screws                         | 6838            | Nissan Body Hardware                          | 6863            | External & Internal Retaining Rings     |
| 6811            | Specialty Screws                     | 6839            | Toyota Body Hardware                          | 6864            | Door Lock Rod Clips                     |
| 6812            | Black Tapping Screws                 | 6840            | Pan'l Blind Rivets                            | 6865            | Weatherstrip Retainers                  |
| 6813            | Teks® Screws                         | 6841            | Specialty Rivets                              | 6866            | Rubber Bumpers                          |
| 6814            | Body Bolts                           | 6842            | Nylon Insulated Terminals                     | 6867            | Wire Loom Clips                         |
| 6815            | Tubular, Flat, U & J-Nuts            | 6843            | Vinyl Insulated Terminals                     | 6868            | Shims                                   |
| 6816            | Extruded U-Nuts                      | 6845            | GM "Xmas Tree" Retainers                      | 6869            | Fender Washers                          |
| 6817            | Washer Type Nuts & Push-On Retainers | 6846            | Ford "Xmas Tree" Retainers                    | 6870            | GM, Ford & Chrysler Push-Type Retainers |
| 6818            | Cotter Pins                          | 6847            | Chrysler "Xmas Tree" Retainers                | 6871            | Hyundai & Kia Clips & Fasteners         |
| 6820            | Oil Drain Plug Gaskets               | 6848            | Chrome Phillips Oval Head Tapping Screws      |                 |   |
| 6821            | Glass Shop Rivets                    | 6850            | Black Phillips Oval Head Tapping Screws       |                 |   |
| 6822            | GM Window Guides                     | 6851            | Zinc & Black Phillips Pan Head Tapping Screws |                 |   |
| 6825            | Oil Drain Plug Gaskets               |                 |   |                 |   |

### Empty Compartment Boxes

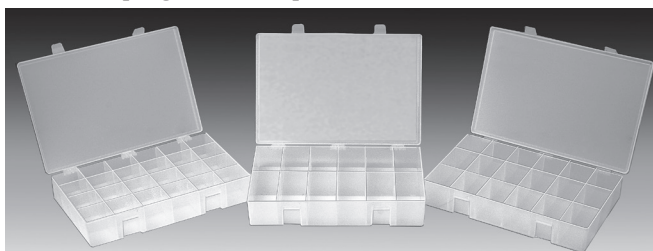

Translucent Durable Polypropylene Boxes with Locking Tabs  
6-3/4" Wide x 11" Deep x 1-3/4" High

**6 Compartment Box**  
68-6: UNIT PACKAGE: 1

**12 Compartment Box**  
68-12: UNIT PACKAGE: 1  
68-112: UNIT PACKAGE: 10

**18 Compartment Box**  
68-18: UNIT PACKAGE: 1  
68-118: UNIT PACKAGE: 10

### Quik-Select Rack



**68-RACK**

Empty Cabinet: Holds 5 Quik-Select Assortments.  
11-1/4" Wide x 6-3/4" Deep x 10-3/4" High  
Finish: Gray Enamel  
Keyhole slots are furnished for wall mounting.  
A handle is provided and bolt holes permits stacking.

UNIT PACKAGE: 1

*Photos not actual size*



**6848**

Phillips Oval Head Tapping Screws  
Chrome Plated  
18 Varieties - 200 Pieces

| Auveco Part No. | Size                     |
|-----------------|--------------------------|
| 2698            | #6 x 1/2"                |
| 1794            | #6 x 3/4"                |
| 1796            | #6 x 1"                  |
| 2707            | #8 x 1/2"                |
| 2027            | #8 x 1/2" with #6 Head   |
| 2710            | #8 x 3/4"                |
| 1799            | #8 x 3/4" with #6 Head   |
| 2713            | #8 x 1"                  |
| 1483            | #8 x 1" with #6 Head     |
| 2716            | #8 x 1-1/4"              |
| 1423            | #8 x 1-1/4" with #6 Head |
| 2718            | #8 x 1-1/2"              |
| 1932            | #8 x 1-1/2" with #6 Head |
| 1933            | #8 x 1-3/4" with #6 Head |
| 2728            | #10 x 3/4"               |
| 1717            | #10 x 3/4" with #8 Head  |
| 2731            | #10 x 1"                 |
| 2730            | #10 x 1" with #8 Head    |



**6850**

Phillips Oval Head Tapping Screws  
Black Oxide Plated  
18 Varieties - 339 Pieces

| Auveco Part No. | Size                     |
|-----------------|--------------------------|
| 12795           | #6 x 1/2"                |
| 12796           | #6 x 3/4"                |
| 12797           | #6 x 1"                  |
| 10163           | #8 x 1/2"                |
| 10162           | #8 x 1/2" with #6 Head   |
| 10165           | #8 x 3/4"                |
| 10164           | #8 x 3/4" with #6 Head   |
| 10167           | #8 x 1"                  |
| 10166           | #8 x 1" with #6 Head     |
| 10169           | #8 x 1-1/4"              |
| 10168           | #8 x 1-1/4" with #6 Head |
| 10171           | #8 x 1-1/2"              |
| 10170           | #8 x 1-1/2" with #6 Head |
| 11086           | #10 x 3/4"               |
| 11087           | #10 x 3/4" with #8 Head  |
| 11088           | #10 x 1"                 |
| 11089           | #10 x 1" with #8 Head    |
| 11092           | #10 x 1-1/2"             |

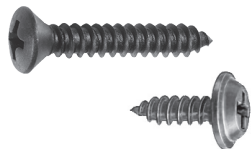

**6812**

Black Tapping Screws  
18 Varieties - 312 Pieces

| Auveco Part No.                                   | Size        |
|---|-------------|
| <b>Black E-Coat<br/>Phillips Flat Washer Head</b> |             |
| 12213   | #8 x 1/2"   |
| 12214   | #8 x 5/8"   |
| 12215   | #8 x 3/4"   |
| 12216   | #8 x 1"     |
| 12217   | #8 x 1-1/4" |
| 12218   | #8 x 1-1/2" |
| 12953   | #10 x 3/4"  |
| 12954   | #10 x 1"    |

**Black Oxide  
Phillips Oval Head**

|       |                         |
|-------|-------------------------|
| 10162 | #8 x 1/2" with #6 Hd.   |
| 10163 | #8 x 1/2"               |
| 10164 | #8 x 3/4" with #6 Hd.   |
| 10165 | #8 x 3/4"               |
| 10166 | #8 x 1" with #6 Hd.     |
| 10167 | #8 x 1"                 |
| 10168 | #8 x 1-1/4" with #6 Hd. |
| 10169 | #8 x 1-1/4"             |
| 10170 | #8 x 1-1/2" with #6 Hd. |
| 10171 | #8 x 1-1/2"             |

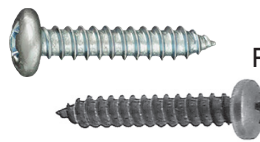

**6851**

Phillips Pan Head Tapping Screws  
Plated  
18 Varieties - 457 Pieces

| Auveco Part No. | Size       |
|-----------------|------------|
| <b>Zinc</b>     |            |
| 1940            | #8 x 1/2"  |
| 2365            | #8 x 3/4"  |
| 3079            | #8 x 1"    |
| 1943            | #10 x 1/2" |
| 2366            | #10 x 3/4" |
| 3082            | #10 x 1"   |
| 2367            | #12 x 3/4" |
| 3090            | #14 x 3/4" |

**Black Oxide**

|       |             |
|-------|-------------|
| 11917 | #6 x 1/2"   |
| 11918 | #6 x 3/4"   |
| 10180 | #8 x 1/2"   |
| 10181 | #8 x 3/4"   |
| 10182 | #8 x 1"     |
| 10183 | #8 x 1-1/4" |
| 12799 | #8 x 1-1/2" |
| 11921 | #10 x 1/2"  |
| 11922 | #10 x 3/4"  |
| 11923 | #10 x 1"    |

# "6800" SERIES QUIK-SELECT ASSORTMENTS

Photos not actual size

**Sec. 15**



**6810**  
Sems® Screws  
Plated  
18 Varieties - 140 Pieces

| Auveco Part No. | Size  |
|-----------------|---|
| <b>Chrome</b>   |   |
| 3538            | #6 x 3/4"                                   |
| 2771            | #8 x 5/8" with #6 Hd.                       |
| 2751            | #8 x 3/4" with #6 Hd.                       |
| 11450           | #8 x 3/4", Teks                             |
| 2775            | #8 x 7/8" with #6 Hd.,<br>with Flush Washer |
| 2772            | #8 x 1" with #6 Hd.                         |
| 2773            | #8 x 1-1/4" with #6 Hd.                     |
| 3465            | #10 x 5/8" with #8 Hd.                      |
| 3466            | #10 x 3/4" with #8 Hd.                      |
| 3467            | #10 x 1" with #8 Hd.                        |
| <b>Black</b>    |   |
| 11787           | #8 x 5/8" with #6 Hd.                       |
| 11454           | #8 x 5/8", Teks                             |
| 11788           | #8 x 3/4" with #6 Hd.                       |
| 11455           | #8 x 3/4", Teks                             |
| 11789           | #8 x 1" with #6 Hd.                         |
| 12957           | #8 x 1" with #6 Hd.<br>with Flush Washer    |
| 11791           | #10 x 3/4" with #8 Hd.                      |
| 11792           | #10 x 1" with #8 Hd.                        |



**6813**  
Pan Head & Hex Washer  
Head Teks® Screws  
Zinc Plated  
18 Varieties - 127 Pieces



| Auveco Part No.        | Size         |
|------------------------|--------------|
| <b>Pan Head</b>        |              |
| 12095                  | #8 x 1/2"    |
| 9605                   | #8 x 1/2"    |
| 9606                   | #8 x 3/4"    |
| 9607                   | #10 x 1/2"   |
| 9608                   | #10 x 3/4"   |
| 9609                   | #10 x 1"     |
| <b>Hex Washer Head</b> |              |
| 9611                   | #8 x 1/2"    |
| 9612                   | #8 x 3/4"    |
| 9613                   | #10 x 1/2"   |
| 9614                   | #10 x 5/8"   |
| 9615                   | #10 x 3/4"   |
| 9616                   | #10 x 1"     |
| 11911                  | #12 x 1"     |
| 11913                  | #12 x 1-1/2" |
| 9620                   | #14 x 3/4"   |
| 11914                  | #14 x 1"     |
| 11915                  | #14 x 1-1/4" |
| 11916                  | #14 x 1-1/2" |



**6852**  
Stainless Steel Tapping Screws  
12 Varieties - 216 Pieces

| Auveco Part No. | Size        | Head |
|-----------------|-------------|------|
| 9400            | #6 x 3/4"   | Oval |
| 9404            | #8 x 3/4"   | Oval |
| 9405            | #8 x 1"     | Oval |
| 9407            | #8 x 1-1/2" | Oval |
| 9409            | #10 x 3/4"  | Oval |
| 9410            | #10 x 1"    | Oval |
| 13269           | #8 x 1/2"   | Pan  |
| 13270           | #8 x 3/4"   | Pan  |
| 13271           | #8 x 1"     | Pan  |
| 13274           | #10 x 1/2"  | Pan  |
| 13275           | #10 x 3/4"  | Pan  |
| 13276           | #10 x 1"    | Pan  |



**6811**  
Specialty Screws  
12 Varieties - 332 Pieces

| Auveco Part No. | Size             |
|-----------------|------------------|
| 10642           | #8 x 3/8"        |
| 2805            | #8 x 7/16"       |
| 13025           | #8 x 1/2"        |
| 12095           | #8 x 1/2" Teks®  |
| 2806            | #8 x 5/8"        |
| 13026           | #8 x 3/4"        |
| 12739           | M4.2-1.41 x 12mm |
| 13712           | M4.2-1.41 x 13mm |
| 18340           | M4.8-1.61 x 15mm |
| 17459           | M4.8-1.61 x 16mm |
| 20259           | M4.8-1.61 x 19mm |
| 20455           | M4.8-2.12 x 20mm |



**6808**  
License Plate Hardware  
12 Varieties - 171 Pieces



Contains the following Auveco part numbers:  
1313, 2472, 2625, 3182, 5228, 5278, 8250, 8427,  
8435, 9603, 11370, 11719 & 14473.



**6814**  
Body Bolts  
12 Varieties - 101 Pieces

| Auveco Part No. | Size             |
|-----------------|------------------|
| 11320           | 5/16"-18 x 1"    |
| 12693           | M6-1.0 x 20mm    |
| 12324           | M6-1.0 x 20mm    |
| 12160           | M6-1.0 x 22mm    |
| 12065           | M6-1.0 x 25mm    |
| 12066           | M6-1.0 x 25mm    |
| 12323           | M6-1.0 x 25mm    |
| 12335           | M6-1.0 x 28mm    |
| 12351           | M6.3-1.81 x 20mm |
| 13613           | M8-1.25 x 25mm   |
| 13614           | M8-1.25 x 30mm   |
| 11640           | M8-1.25 x 30mm   |

*Photos not actual size*



**6854**

Metric Specialty Screws  
18 Varieties - 145 Pieces

| Auveco Part No. | Size             |
|-----------------|------------------|
| 12062           | M4.2-1.41 x 10mm |
| 12739           | M4.2-1.41 x 12mm |
| 13712           | M4.2-1.41 x 13mm |
| 12741           | M4.2-1.41 x 16mm |
| 12060           | M4.2-1.41 x 20mm |
| 12738           | M4.2-1.41 x 20mm |
| 12742           | M4.2-1.41 x 20mm |
| 15373           | M4.2-1.41 x 20mm |
| 15775           | M4.2-1.41 x 20mm |
| 17459           | M4.8-1.81 x 16mm |
| 12057           | M6.3-1.81 x 16mm |
| 15962           | M6.3-1.81 x 18mm |
| 12351           | M6.3-1.81 x 20mm |
| 16828           | M6.3-1.81 x 20mm |
| 12339           | M6.3-1.81 x 25mm |
| 12068           | M6.3-1.81 x 30mm |
| 12354           | M6.3-1.81 x 30mm |
| 12350           | M8-2.12 x 20mm   |

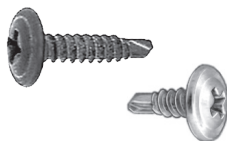

**6853**

Specialty Screws  
12 Varieties - 198 Pieces

| Auveco Part No. | Size       |
|-----------------|------------|
| 10642           | #8 x 3/8"  |
| 15037           | #8 x 7/16" |
| 2805            | #8 x 7/16" |
| 12095           | #8 x 1/2"  |
| 15172           | #8 x 1/2"  |
| 15774           | #8 x 1/2"  |
| 2806            | #8 x 5/8"  |
| 12820           | #8 x 3/4"  |
| 13026           | #8 x 3/4"  |
| 17650           | #8 x 3/4"  |
| 13709           | #10 x 3/4" |
| 16589           | #10 x 3/4" |



**6858**

Pushnut Bolt Retainers  
18 Varieties - 314 Pieces

| Auveco Part No. | Size        |
|-----------------|-------------|
| 16851           | #6 (9/64")  |
| 10085           | #8 (5/32")  |
| 16852           | #10 (3/16") |
| 10086           | 1/4"        |
| 10087           | 5/16"       |
| 9297            | 3/8"        |
| 9298            | 7/16"       |
| 9299            | 1/2"        |
| 12122           | M5-0.8      |
| 12123           | M6-1.0      |
| 14980           | M6-1.0      |
| 12124           | M6.3-1.0    |
| 12125           | M8-1.25     |
| 12259           | M8-1.25     |
| 12126           | M10-1.50    |
| 12260           | M10-1.50    |
| 12127           | M12-1.75    |
| 16980           | M14-2.0     |



**6817**

Washer Type  
Thread Cutting Nuts  
& Push-on Retainers  
18 Varieties - 385 Pieces

| Auveco Part No.            | Size            |
|----------------------------|-----------------|
| <b>Thread Cutting Nuts</b> |                 |
| 12253                      | 5mm Stud Size   |
| 3403                       | 1/8" Stud Size  |
| 3404                       | 3/16" Stud Size |
| 2896                       | 3/16" Stud Size |
| 2897                       | 1/4" Stud Size  |
| 3405                       | 1/4" Stud Size  |
| 10733                      | 5/16" Stud Size |
| <b>Push-On Retainers</b>   |                 |
| 8863                       | 1/8" Stud Size  |
| 8864                       | 5/32" Stud Size |
| 8865                       | 3/16" Stud Size |
| 8868                       | 1/4" Stud Size  |
| <b>Bolt Retainers</b>      |                 |
| 10086                      | 1/4" Bolt Size  |
| 10087                      | 5/16" Bolt Size |
| 9297                       | 3/8" Bolt Size  |
| 12123                      | 6mm Bolt Size   |
| 12125                      | 8mm Bolt Size   |
| 12259                      | 8mm Bolt Size   |
| 12126                      | 10mm Bolt Size  |

**DON'T SEE THE ASSORTMENT YOU WANT?**

Although we offer over 100 different assortments, we know you have some great ideas for new ones.

Send us those ideas so we make sure our customers get the best we can offer.

Email suggestions to [mail@auveco.com](mailto:mail@auveco.com)

# "6800" SERIES QUIK-SELECT ASSORTMENTS

Photos not actual size

**Sec. 15**

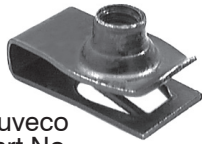

## 6816

Extruded U-Nuts (Foldover Nuts)  
12 Varieties - 70 Pieces

| Auveco Part No. | Size       | Center of Hole to Edge |
|-----------------|------------|------------------------|
| 8359            | 1/4" - 20  | 17/32"                 |
| 10051           | 1/4" - 20  | 25/32"                 |
| 10053           | 5/16" - 18 | 9/16"                  |
| 8814            | 5/16" - 18 | 27/32"                 |
| 10054           | 3/8" - 16  | 3/4"                   |
| 10055           | 3/8" - 16  | 1-1/8"                 |
| 12669           | M6 - 1.0   | 13.5mm                 |
| 12575           | M6 - 1.0   | 19.5mm                 |
| 11628           | M6.3 - 1.0 | 13.5mm                 |
| 11629           | M8 - 1.25  | 14.5mm                 |
| 11630           | M8 - 1.25  | 20mm                   |
| 11631           | M10 - 1.5  | 19mm                   |



## 6857

Thread Cutting & Washer Lock Nuts  
18 Varieties - 227 Pieces



| Auveco Part No.            | Size            |
|----------------------------|-----------------|
| <b>Thread Cutting Nuts</b> |                 |
| 2895                       | 1/8" Stud Size  |
| 3403                       | 1/8" Stud Size  |
| 8855                       | 5/32" Stud Size |
| 2896                       | 3/16" Stud Size |
| 3404                       | 3/16" Stud Size |
| 3405                       | 1/4" Stud Size  |
| 2897                       | 1/4" Stud Size  |
| 10733                      | 5/16" Stud Size |
| 12253                      | 5mm Stud Size   |
| 12255                      | 6.3mm Stud Size |
| 15711                      | 8mm Stud Size   |
| <b>Washer Lock Nuts</b>    |                 |
| 2554                       | #6-32 Thread    |
| 2555                       | #8-32 Thread    |
| 2557                       | #10-24 Thread   |
| 2558                       | #10-24 Thread   |
| 2560                       | #12-24 Thread   |
| 2561                       | 1/4"-20 Thread  |
| 2562                       | 1/4"-20 Thread  |



## 6869

Fender Washers  
12 Varieties - 155 Pieces

| Auveco Part No. | Bolt Size | Outer Diameter |
|-----------------|-----------|----------------|
| 2007            | 3/16"     | 1/2"           |
| 1183            | 3/16"     | 3/4"           |
| 16018           | 3/16"     | 1"             |
| 16020           | 1/4"      | 1"             |
| 2333            | 1/4"      | 1-1/4"         |
| 768             | 5/16"     | 1-1/4"         |
| 17095           | 5/16"     | 1-1/4"         |
| 1700            | 5/16"     | 1-1/2"         |
| 3553            | 3/8"      | 1-1/4"         |
| 2227            | 3/8"      | 1-1/2"         |
| 1294            | 3/8"      | 1-3/4"         |
| 17094           | 3/8"      | 1-3/4"         |

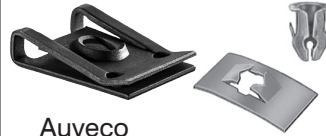

## 6815

Nuts: Tubular, Flat, J & U  
18 Varieties - 148 Pieces

| Auveco Part No. | Size     | Type    |
|-----------------|----------|---------|
| 2595            | 1/8"     | Tubular |
| 10073           | 3/16"    | Tubular |
| 2099            | 1/8"     | Flat    |
| 2092            | #10-24   | Flat    |
| 1903            | 1/4"-20  | Flat    |
| 5586            | 1/4"-20  | J-Nut   |
| 5589            | 5/16"-18 | J-Nut   |
| 5170            | 3/8"-16  | J-Nut   |
| 10666           | #8       | U-Nut   |
| 11292           | #8       | U-Nut   |
| 5197            | #10-24   | U-Nut   |
| 2293            | 1/4"-20  | U-Nut   |
| 9879            | #8       | U-Nut   |
| 9880            | #8       | U-Nut   |
| 10064           | #6       | U-Nut   |
| 10065           | #8       | U-Nut   |
| 10066           | #10      | U-Nut   |
| 10067           | #14      | U-Nut   |



## 6856

External & Internal Lock Washers  
12 Varieties - 685 Pieces



| Auveco Part No. | Size        |
|-----------------|-------------|
| <b>External</b> |             |
| 5251            | #8 (5/32")  |
| 5252            | #10 (3/16") |
| 5254            | #14 (1/4")  |
| 5255            | 5/16"       |
| 5256            | 3/8"        |
| 5257            | 7/16"       |
| <b>Internal</b> |             |
| 5261            | #8 (5/32")  |
| 5262            | #10 (3/16") |
| 5264            | #14 (1/4")  |
| 5265            | 5/16"       |
| 5266            | 3/8"        |
| 5267            | 7/16"       |



## 6868

Shims - Zinc Plated  
6 Varieties - 100 Pieces

| Auveco Part No. | Size            | Thickness |
|-----------------|-----------------|-----------|
| 2453            | 1-3/4" x 1-1/4" | 1/8"      |
| 3000            | 2" x 1-1/2"     | 1/8"      |
| 3155            | 1-1/4" x 1-1/8" | 1/16"     |
| 3156            | 1-1/4" x 1-1/8" | 1/8"      |
| 5076            | 1-1/8" x 1-1/8" | 1/16"     |
| 5077            | 1-1/8" x 1-1/8" | 1/8"      |

*Photos not actual size*



**6830**  
Hair Pin Cotter  
6 Varieties - 73 Pieces

| Auveco Part No. | Overall Length |
|-----------------|----------------|
| 10397           | 3-15/16"       |
| 11872           | 1-9/16"        |
| 10398           | 4"             |
| 10395           | 2-1/2"         |
| 10396           | 3-3/4"         |
| 10394           | 2-5/16"        |



**6818**  
Cotter Pins  
Zinc Plated  
18 Varieties - 570 Pieces

| Auveco Part No. | Size           |
|-----------------|----------------|
| 8477            | 1/16" x 1/2"   |
| 8478            | 1/16" x 3/4"   |
| 8479            | 1/16" x 1"     |
| 8480            | 1/16" x 1-1/2" |
| 8481            | 3/32" x 3/4"   |
| 8482            | 3/32" x 1"     |
| 8484            | 3/32" x 1-1/2" |
| 8485            | 3/32" x 2"     |
| 8486            | 1/8" x 1"      |
| 8487            | 1/8" x 1-1/4"  |
| 8488            | 1/8" x 1-1/2"  |
| 8489            | 1/8" x 1-3/4"  |
| 8490            | 1/8" x 2"      |
| 8492            | 5/32" x 1"     |
| 8493            | 5/32" x 1-1/2" |
| 8494            | 5/32" x 2"     |
| 8495            | 3/16" x 1-1/2" |
| 8496            | 3/16" x 2"     |



**6863**  
External & Internal Retaining Rings  
Zinc Plated  
18 Varieties - 151 Pieces



| Auveco Part No.      | Shaft Diameter |
|----------------------|----------------|
| <b>Internal Type</b> |                |
| 8688                 | 1/4"           |
| 8689                 | 5/16"          |
| 8690                 | 3/8"           |
| 8691                 | 7/16"          |
| 8693                 | 9/16"          |
| 8694                 | 5/8"           |
| <b>External Type</b> |                |
| 8701                 | 1/4"           |
| 8702                 | 5/16"          |
| 8703                 | 3/8"           |
| 8704                 | 7/16"          |
| 8705                 | 1/2"           |
| 8706                 | 9/16"          |
| 8707                 | 5/8"           |
| 8708                 | 3/4"           |
| 8709                 | 7/8"           |
| 8710                 | 1"             |
| 8712                 | 1-1/4"         |
| 10125                | 1-1/2"         |



**6831**  
Plastic Plug Buttons  
6 Varieties - 305 Pieces



| Auveco Part No.              | Size |
|------------------------------|------|
| <b>Depressed Center Type</b> |      |
| 9288                         | 1/2" |
| 9289                         | 3/4" |
| <b>Flush Type</b>            |      |
| 14923                        | 3/8" |
| 11746                        | 1/2" |
| 11747                        | 3/4" |
| 11749                        | 1"   |



**6862**  
E-Type Retaining Rings  
12 Varieties - 343 Pieces

| Auveco Part No. | Shaft Diameter |
|-----------------|----------------|
| 8825            | 3/32"          |
| 8826            | 1/8"           |
| 10131           | 5/32"          |
| 8827            | 3/16"          |
| 10133           | 7/32"          |
| 8828            | 1/4"           |
| 3824            | 5/16"          |
| 8829            | 3/8"           |
| 8830            | 7/16"          |
| 5602            | 1/2"           |
| 5603            | 5/8"           |
| 8831            | 3/4"           |

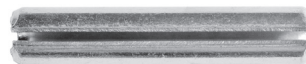

**6861**  
Spring Pins  
Zinc Plated  
12 Varieties - 174 Pieces

| Auveco Part No. | Size           |
|-----------------|----------------|
| 9006            | 1/8" x 3/4"    |
| 9008            | 1/8" x 1"      |
| 9010            | 1/8" x 1-1/2"  |
| 9016            | 5/32" x 1"     |
| 9018            | 5/32" x 1-1/2" |
| 9022            | 3/16" x 1"     |
| 9024            | 3/16" x 1-1/2" |
| 9026            | 3/16" x 2"     |
| 9033            | 1/4" x 1"      |
| 9035            | 1/4" x 1-1/2"  |
| 9037            | 1/4" x 2"      |
| 9045            | 5/16" x 2"     |

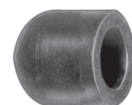

**6826**  
Rubber Vacuum Caps  
6 Varieties - 121 Pieces



| Auveco Part No. | Size                 |
|-----------------|----------------------|
| 12209           | Fits 1/8" O.D. Tube  |
| 4440            | Fits 3/16" O.D. Tube |
| 4439            | Fits 1/4" O.D. Tube  |
| 12907           | Fits 5/16" O.D. Tube |
| 12210           | Fits 3/8" O.D. Tube  |
| 12908           | Fits 1/2" O.D. Tube  |

# "6800" SERIES QUIK-SELECT ASSORTMENTS

Photos not actual size

Sec. 15

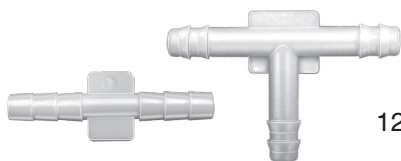

## 6836

Nylon Connectors  
12 Varieties - 83 Pieces

| Auveco Part No. | Size                  | Type     |
|-----------------|-----------------------|----------|
| 11738           | 1/4" x 1/4" x 3/16"   | Tee      |
| 12918           | 3/16 x 3/16" x 3/16"  | Tee      |
| 12919           | 1/4" x 3/16" x 3/16"  | Tee      |
| 12920           | 5/16" x 5/16" x 5/16" | Tee      |
| 12921           | 3/8" x 3/8" x 1/4"    | Tee      |
| 12923           | 1/8" x 1/8" x 1/8"    | Tee      |
| 12926           | 3/16" x 3/16" x 1/8"  | Tee      |
| 12929           | 1/8" x 1/8"           | Straight |
| 12930           | 1/8" x 3/16"          | Straight |
| 12931           | 1/4" x 1/4"           | Straight |
| 12935           | 1/4" x 3/16"          | Straight |
| 12937           | 3/16" x 3/16"         | Straight |



## 6867

Wire Loom Routing Clips  
6 Varieties - 42 Pieces

| Auveco Part No. | For Loom Size            |
|-----------------|--------------------------|
| 14544           | 11/32" I.D., 1/2" O.D.   |
| 14545           | 13/32" I.D., 19/32" O.D. |
| 14546           | 1/2" I.D., 11/16" O.D.   |
| 14547           | 3/4" I.D., 1" O.D.       |
| 16941           | 1" I.D., 1-9/32" O.D.    |
| 19440           | 1/4" I.D., 3/8" O.D.     |



## 6825

Oil Drain Plug Gaskets  
12 Varieties  
84 Pieces



| Auveco Part No. | Size  | Type           |
|-----------------|-------|----------------|
| 8277            | 1/2"  | Nylon          |
| 15918           | 1/2"  | Copper         |
| 15919           | 9/16" | Copper         |
| 16026           | 1/2"  | Steel & Rubber |
| 16682           | 14mm  | Fibre          |
| 16955           | 18mm  | Aluminum       |
| 16956           | 14mm  | Aluminum       |
| 16996           | 1/2"  | Nylon          |
| 18299           | 14mm  | Steel & Rubber |
| 18665           | 11mm  | Rubber         |
| 18726           | 12mm  | Fibre          |
| 19630           | 11mm  | Rubber         |

## 6820

Oil Drain Plug Gaskets  
12 Varieties - 120 Pieces



| Auveco Part No. | Size  | Type  |
|-----------------|-------|-------|
| 8277            | 1/2"  | Nylon |
| 8278            | 5/8"  | Nylon |
| 8279            | 3/4"  | Nylon |
| 8281            | 9/16" | Nylon |
| 16680           | 12mm  | Nylon |
| 16681           | 14mm  | Nylon |
| 16682           | 14mm  | Fibre |
| 16685           | 20mm  | Nylon |
| 16996           | 1/2"  | Nylon |
| 21647           | 20mm  | Fibre |
| 18019           | 1/2"  | Fibre |
| 18726           | 12mm  | Fibre |



## 6859

Hose Connectors  
12 Varieties - 61 Pieces

| Auveco Part No. | Size                  | Type     |
|-----------------|-----------------------|----------|
| 10101           | 1/8" x 1/8"           | Straight |
| 10102           | 3/16" x 3/16"         | Straight |
| 10103           | 1/4" x 1/4"           | Straight |
| 10104           | 5/16" x 5/16"         | Straight |
| 10105           | 3/8" x 3/8"           | Straight |
| 10106           | 1/4" x 3/16"          | Straight |
| 10107           | 3/8" x 1/4"           | Straight |
| 10697           | 1/8" x 1/8" x 1/8"    | Tee      |
| 10108           | 5/32" x 5/32" x 5/32" | Tee      |
| 10109           | 3/16" x 3/16" x 3/16" | Tee      |
| 10110           | 1/4" x 1/4" x 1/4"    | Tee      |
| 11228           | 3/8" x 3/8" x 3/8"    | Tee      |



## 6843

Vinyl Insulated  
Solderless Terminals  
12 Varieties - 125 Pieces

| Auveco Part No. | Description             |
|-----------------|-------------------------|
| 5023            | Ring Type, 22-18 Gauge  |
| 5026            | Ring Type, 16-14 Gauge  |
| 5027            | Ring Type, 16-14 Gauge  |
| 5028            | Ring Type, 12-10 Gauge  |
| 5029            | Ring Type, 12-10 Gauge  |
| 5031            | Ring Type, 12-10 Gauge  |
| 5036            | Spade Type, 16-14 Gauge |
| 5047            | Butt Conn., 22-18 Gauge |
| 5048            | Butt Conn., 16-14 Gauge |
| 5049            | Butt Conn., 12-10 Gauge |
| 12144           | Ring Type, 16-14 Gauge  |
| 17037           | Butt Connector, 8 Gauge |



*Photos not actual size*

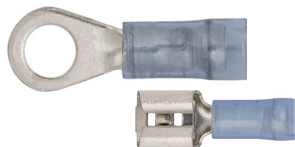

**6842**  
Nylon Insulated  
Solderless Terminals  
12 Varieties - 100 Pieces

| Auveco Part No. | Description              |
|-----------------|--------------------------|
| 5791            | Butt Conn., 22-18 Gauge  |
| 5792            | Butt Conn., 16-14 Gauge  |
| 5793            | Butt Conn., 12-10 Gauge  |
| 9055            | Ring Type, 16-14 Gauge   |
| 9056            | Ring Type, 16-14 Gauge   |
| 9060            | Spade Type, 16-14 Gauge  |
| 12147           | Male Q. C. 16-14 Gauge   |
| 12148           | Female Q.C., 16-14 Gauge |
| 12150           | Ring Type, 22-18 Gauge   |
| 12151           | Ring Type, 12-10 Gauge   |
| 12152           | Ring Type, 12-10 Gauge   |
| 12153           | Ring Type, 12-10 Gauge   |



**6840**  
Pan'l Blind Rivets  
12 Varieties - 291 Pieces

| Auveco Part No.       | Grip       | Type                     |
|-----------------------|------------|--------------------------|
| <b>1/8" Diameter</b>  |            |                          |
| 8309                  | 1/16"-1/8" | Aluminum                 |
| 5753                  | 3/16"-1/4" | Steel                    |
| 8925                  | 3/16"-1/4" | Aluminum                 |
| 8931                  | 3/16"-1/4" | Aluminum<br>Large Flange |
| <b>5/16"-3/8"</b>     |            |                          |
| 8880                  | 5/16"-3/8" | Steel                    |
| 16031                 | 5/16"-3/8" | Aluminum                 |
| 16032                 | 3/8"-1/2"  | Aluminum                 |
| <b>3/16" Diameter</b> |            |                          |
| 5755                  | 1/16"-1/8" | Aluminum                 |
| 8311                  | 1/8"-1/4"  | Aluminum                 |
| 8301                  | 1/4"-3/8"  | Aluminum                 |
| 8313                  | 1/4"-3/8"  | Aluminum<br>Large Flange |
| 8938                  | 3/8"-1/2"  | Aluminum                 |



**6841**  
Specialty Rivets  
12 Varieties - 66 Pieces

| Auveco Part No.       | Grip          | Type      |
|-----------------------|---------------|-----------|
| <b>1/8" Diameter</b>  |               |           |
| 16834                 | 1/8"-3/16"    |           |
| 17615                 | 3/16"-3/8"    |           |
| <b>3/16" Diameter</b> |               |           |
| 16864                 | 3/64"-11/32"  |           |
| 17121                 | 5/64"-15/64"  |           |
| 14127                 | 3/8"-1/2"     |           |
| <b>1/4" Diameter</b>  |               |           |
| 11620                 | 1/32"-9/64"   | Peel-Type |
| 12653                 | 3/32"-1/8"    | Peel-Type |
| 18167                 | 3/32"-9/64"   | Peel-Type |
| 12652                 | 1/8"-1/4"     |           |
| 12655                 | 9/64"-3/16"   | Peel-Type |
| 17639                 | 3/16"-3/8"    |           |
| 11621                 | 33/64"-19/32" | Peel-Type |



**6806**  
Nylon Rivets  
12 Varieties  
74 Pieces

| Auveco Part No. | Diameter | Grip          |
|-----------------|----------|---------------|
| 13746           | 3/16"    | 1/16"-9/64"   |
| 13747           | 13/64"   | 1/16"-11/64"  |
| 13748           | 13/64"   | 1/8"-15/64"   |
| 13755           | 13/64"   | 15/64"-25/64" |
| 14004           | 15/64"   | 11/64"-11/32" |
| 14023           | 15/64"   | 5/32"-5/16"   |
| 18108           | 1/4"     | 5/32"-3/8"    |
| 13750           | 1/4"     | 5/32"-13/32"  |
| 13751           | 1/4"     | 5/32"-13/32"  |
| 17101           | 1/4"     | 5/16"-15/32"  |
| 13752           | 17/64"   | 3/32"-3/16"   |
| 13753           | 17/64"   | 3/32"-3/16"   |



**6827**  
Rubber Grommets  
18 Varieties - 99 Pieces

| Auveco Part No. | Bore Diameter | Width |
|-----------------|---------------|-------|
| 4408            | 1/8"          | 3/32" |
| 4410            | 5/32"         | 1/16" |
| 4413            | 3/16"         | 1/16" |
| 4414            | 3/16"         | 3/32" |
| 4415            | 3/16"         | 1/4"  |
| 4417            | 1/4"          | 1/16" |
| 4419            | 5/16"         | 1/16" |
| 4421            | 5/16"         | 1/8"  |
| 4422            | 5/16"         | 1/4"  |
| 4423            | 3/8"          | 1/16" |
| 4425            | 3/8"          | 1/16" |
| 4426            | 3/8"          | 1/4"  |
| 4428            | 1/2"          | 3/32" |
| 4430            | 1/2"          | 1/4"  |
| 4431            | 5/8"          | 1/8"  |
| 4432            | 5/8"          | 1/16" |
| 4434            | 3/4"          | 1/16" |
| 4436            | 3/4"          | 1/4"  |



**6821**  
Glass Shop Rivets  
6 Varieties - 63 Pieces

| Auveco Part No. | Diameter | Grip          |
|-----------------|----------|---------------|
| 11620           | 1/4"     | 1/32"-9/64"   |
| 11621           | 1/4"     | 33/64"-19/32" |
| 11852           | 1/4"     | 5/64"-7/64"   |
| 12653           | 1/4"     | 3/32"-1/8"    |
| 12655           | 1/4"     | 9/64"-3/16"   |
| 16834           | 1/8"     | 1/8"-3/16"    |

# "6800" SERIES QUIK-SELECT ASSORTMENTS

**Sec. 15**

*Photos not actual size*



**6835**  
Rubber O-Rings  
Buna-N  
18 Varieties - 770 Pieces

| Auveco Part No. | Industry Standard | Inner Diameter | Outer Diameter |
|-----------------|-------------------|----------------|----------------|
| 4305            | 006               | 1/8"           | 1/4"           |
| 4306            | 007               | 5/32"          | 9/32"          |
| 4307            | 008               | 3/16"          | 5/16"          |
| 4308            | 009               | 7/32"          | 11/32"         |
| 4309            | 010               | 1/4"           | 3/8"           |
| 4310            | 011               | 5/16"          | 7/16"          |
| 4311            | 012               | 3/8"           | 1/2"           |
| 4312            | 110               | 3/8"           | 9/16"          |
| 4313            | 111               | 7/16"          | 5/8"           |
| 4314            | 112               | 1/2"           | 11/16"         |
| 4315            | 113               | 9/16"          | 3/4"           |
| 4316            | 114               | 5/8"           | 13/16"         |
| 4317            | 115               | 11/16"         | 7/8"           |
| 4318            | 116               | 3/4"           | 15/16"         |
| 4319            | 210               | 3/4"           | 1"             |
| 4320            | 211               | 13/16"         | 1-1/16"        |
| 4321            | 212               | 7/8"           | 1-1/8"         |
| 4323            | 214               | 1"             | 1-1/4"         |



**6866**  
Rubber Bumpers  
12 Varieties  
105 Pieces

Auveco Part No.

Application

|      |                        |
|------|------------------------|
| 4155 | General Purpose        |
| 4188 | Door & Quarter Glass   |
| 4233 | General Purpose        |
| 4235 | Hood & Fender          |
| 4237 | General Purpose        |
| 4240 | Door                   |
| 4242 | Hood, Trunk & Deck Lid |
| 4244 | General Purpose        |
| 4246 | Gas Tank Lid           |
| 4249 | General Purpose        |
| 4250 | Glove Box Door         |
| 4280 | License Plate          |



**6809**  
Window Reveal Moulding Clips  
GM & Ford  
12 Varieties - 132 Pieces

Contains the following Auveco part numbers:  
**8583, 8941, 9633 9639, 9882, 10243, 10630, 10631  
11067, 11152, 11345 & 13564.**



**6801**  
GM "Xmas Tree" Retainers  
12 Varieties - 118 Pieces

Contains the following Auveco part numbers:  
**10621, 10831, 10832, 11146, 11612,  
11678, 11796, 12137, 12731,  
12737, 12766 & 12992.**



**6802**  
Ford "Xmas Tree" Retainers  
12 Varieties - 112 Pieces

Contains the following Auveco part numbers:  
**10831, 11136, 11351, 11671, 11797, 12565,  
12571, 12909, 14021, 14163, 17612 & 19655**



**6803**  
Chrysler "Xmas Tree Retainers"  
6 Varieties - 113 Pieces

Contains the following Auveco part numbers:  
**10831, 11136, 11146, 11351, 11678 & 17004**



**6822**  
GM Window Guides  
6 Varieties - 30 Pieces

Auveco Part No.

O.E.M. No.

|       |                    |
|-------|--------------------|
| 15462 | 20478733           |
| 15463 | 20487630, 20712176 |
| 15466 | 20160591           |
| 15467 | 20123070, 20328600 |
| 17159 | 20747509           |
| 17176 | 20162174, 22543363 |

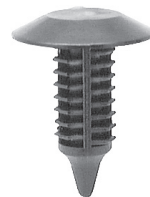

**6845**  
GM "Xmas Tree" Retainers  
11 Varieties - 118 Pieces

Contains the following Auveco part numbers:  
**11120, 12759, 13461, 14032, 14036, 15367,  
15456, 15669, 15970, 16818 & 17664**



**6846**  
Ford "Xmas Tree" Retainers  
12 Varieties - 112 Pieces

Contains the following Auveco part numbers:  
**8853, 11136, 11672, 13470, 14757, 15478,  
15479, 15480, 17102, 17339, 19655 & 20316**



**6847**  
Chrysler "Xmas Tree" Retainers  
12 Varieties - 113 Pieces

Contains the following Auveco part numbers:  
**11129, 11136, 11675, 11679, 14921, 15481,  
15543, 16818, 17004, 17975, 18033 & 20316**

*Photos not actual size*



**6864**

Door Lock Rod Clips  
12 Varieties - 59 Pieces



Contains the following Auveco part numbers:  
**14967, 15518, 15673, 15674, 15675, 15759, 17069, 17122, 18392, 18393, 18926 & 20675**



**6807**

Nylon Nuts & Grommets  
18 Varieties - 251 Pieces



Contains the following Auveco part numbers:  
**2625, 3682, 8435, 9829, 9862, 10330, 11368, 11691, 11719, 11838, 11841, 11855, 12735, 13450, 13933, 13960, 14009 & 14031**



**6865**

Weatherstrip Retainers  
12 Varieties - 245 Pieces

Auveco  
Part No.

Application

|              |                |
|--------------|----------------|
| <b>8853</b>  | Ford           |
| <b>10744</b> | GM             |
| <b>11120</b> | GM             |
| <b>11129</b> | Chrysler       |
| <b>11612</b> | Ford & GM      |
| <b>14328</b> | Honda          |
| <b>14921</b> | Chrysler & GM  |
| <b>17339</b> | Ford           |
| <b>18033</b> | Chrysler       |
| <b>18692</b> | Mazda & Toyota |
| <b>18877</b> | Honda          |
| <b>19171</b> | Honda          |



**6804**

GM Push-type Retainers  
12 Varieties - 76 Pieces

Contains the following Auveco part numbers:  
**12567, 12757, 13993, 14010, 14011, 14020, 14753, 15044, 15045, 17216, 17222 & 18353.**



**6829**

Honda Body Hardware  
12 Varieties - 92 Pieces

Auveco  
Part No.

Description

|              |                    |
|--------------|--------------------|
| <b>14268</b> | Screw Grommet      |
| <b>14274</b> | Nylon Nut          |
| <b>14282</b> | Retaining Clip     |
| <b>14313</b> | Nylon Nut          |
| <b>14695</b> | Screw Grommet      |
| <b>14696</b> | Push-Type Retainer |
| <b>14697</b> | Push-Type Retainer |
| <b>14698</b> | Push-Type Retainer |
| <b>16000</b> | Push-Type Retainer |
| <b>17143</b> | Push-Type Retainer |
| <b>17144</b> | Push-Type Retainer |
| <b>20564</b> | Push-Type Retainer |



**6805**

Ford Push-Type Retainers  
6 Varieties - 68 Pieces

Contains the following Auveco part numbers:  
**11705, 14018, 14019, 14020, 14753 & 18894.**



Auveco  
Part No.

**6837**

Honda Body Hardware  
12 Varieties - 61 Pieces

Description

|              |                     |
|--------------|---------------------|
| <b>14289</b> | Panel Retainer      |
| <b>14291</b> | Retaining Clip      |
| <b>14328</b> | Weatherstrip Clip   |
| <b>16779</b> | Retaining Clip      |
| <b>16782</b> | Push-Type Retainer  |
| <b>17057</b> | Push-Type Retainer  |
| <b>17192</b> | Push-Type Retainer  |
| <b>17205</b> | Retaining Clip      |
| <b>17379</b> | Push-Type Retainer  |
| <b>18114</b> | Insulation Retainer |
| <b>18119</b> | Push-Type Retainer  |
| <b>19233</b> | Push-Type Retainer  |



**6870**

GM, Ford & Chrysler Push-Type Retainers  
11 Varieties - 116 Pieces

Contains the following Auveco part numbers:  
**20826, 20880, 20888, 20889, 20988, 20989, 20990, 20991, 20992, 20993 & 20994.**



**6871**

Hyundai & Kia  
Clips & Fasteners  
18 Varieties - 76 Pieces

Auveco  
Part No.

Description

|              |                             |
|--------------|-----------------------------|
| <b>20543</b> | Hood Insulation Retainer    |
| <b>20566</b> | Moulding Clip               |
| <b>20567</b> | Moulding Clip               |
| <b>20568</b> | Moulding Clip               |
| <b>20680</b> | M6-1.0 L. P. Screw          |
| <b>21064</b> | Moulding Clip               |
| <b>21067</b> | Bumper & Grille Retainer    |
| <b>21068</b> | Nylon Nut                   |
| <b>21070</b> | Trim Panel Retainer         |
| <b>21136</b> | Moulding Clip               |
| <b>21146</b> | Push-Type Retainer          |
| <b>21188</b> | Trim Panel Retainer         |
| <b>21244</b> | Moulding Clip               |
| <b>21312</b> | Moulding Clip               |
| <b>21321</b> | Moulding Clip               |
| <b>21328</b> | Push-Type Retainer          |
| <b>21378</b> | Nylon U-Nut                 |
| <b>21382</b> | Cowl Vent & Grille Retainer |

# "6800" SERIES QUIK-SELECT ASSORTMENTS

**Sec. 15**

*Photos not actual size*



## 6838

Nissan  
Body Hardware  
12 Varieties  
58 Pieces

| Auveco Part No. | Description         |
|-----------------|---------------------|
| 14352           | Retaining Clip      |
| 14355           | Retaining Clip      |
| 16775           | Trim Panel Retainer |
| 16776           | Trim Panel Retainer |
| 16782           | Push-Type Retainer  |
| 16783           | Push-Type Retainer  |
| 16843           | Push-Type Retainer  |
| 17347           | Push-Type Retainer  |
| 17452           | Retaining Clip      |
| 17472           | Push-Type Retainer  |
| 20327           | Push-Type Retainer  |
| 20348           | Push-Type Retainer  |



## 6839

Toyota Body Hardware  
12 Varieties - 73 Pieces

| Auveco Part No. | Description         |
|-----------------|---------------------|
| 14144           | Trim Panel Retainer |
| 14271           | Nylon Nut           |
| 15695           | Retainer            |
| 16779           | Retaining Clip      |
| 17206           | Push-Type Retainer  |
| 17438           | Grille Clip         |
| 18297           | Retaining Clip      |
| 18873           | Push-Type Retainer  |
| 18888           | Push-Type Retainer  |
| 19739           | Push-Type Retainer  |
| 20390           | Moulding Clip       |
| 20391           | Moulding Clip       |



## 6834

Toyota  
Body Hardware  
18 Varieties - 72 Pieces

| Auveco Part No. | Description         |
|-----------------|---------------------|
| 13932           | Nylon Nut           |
| 14260           | Push-Type Retainer  |
| 14265           | Nylon Nut           |
| 14267           | Screw Grommet       |
| 14268           | Screw Grommet       |
| 14269           | Panel Retainer      |
| 14274           | Nylon Nut           |
| 14275           | Screw Grommet       |
| 14276           | Nylon U-Nut         |
| 14695           | Screw Grommet       |
| 14736           | Retaining Clip      |
| 14737           | Retaining Clip      |
| 14738           | Retaining Clip      |
| 14750           | Nylon U-Nut         |
| 16306           | Bumper Cushion Clip |
| 16784           | Push-Type Retainer  |
| 19194           | Screw Grommet       |
| 19721           | Screw Grommet       |

**Please place orders in  
Unit Package quantities,  
not based on pieces needed**

## ASSORTMENTS

*All assortments come in durable translucent polypropylene boxes  
Photos not actual size*



## 19442

Extension Springs  
Zinc Plated  
6 Varieties - 38 Pieces



Contains the following Auveco part numbers:  
14063, 14064, 14065 14067, 14070 & 14072



## 19445

GM O.E.M. Electrical Terminals  
12 Varieties  
223 Pieces

Contains the following Auveco part numbers:  
8774, 8776, 14150, 14151, 14152, 14880, 14881,  
14883, 15497, 15498, 15937 & 15948.

# Sec. 15

# ASSORTMENTS

All assortments come in durable translucent polypropylene boxes  
Photos not actual size



**21534**  
Krimp and Seal Terminals  
& Connectors  
24 Varieties - 159 Pieces

| Auveco Part No. | Description              |
|-----------------|--------------------------|
| 13656           | Ring Type, 22-18 Gauge   |
| 13657           | Ring Type, 22-18 Gauge   |
| 13658           | Spade Type, 22-18 Gauge  |
| 13659           | Butt Conn., 22-18 Gauge  |
| 13660           | Female Q.C. 22-18 Gauge  |
| 13661           | Male Q.C., 22-18 Gauge   |
| 13662           | Ring Type, 16-14 Gauge   |
| 13663           | Ring Type, 16-14 Gauge   |
| 13664           | Ring Type, 16-14 Gauge   |
| 13665           | Ring Type, 16-14 Gauge   |
| 13666           | Ring Type, 16-14 Gauge   |
| 13669           | Butt Conn., 16-14 Gauge  |
| 13670           | Female Q.C., 16-14 Gauge |
| 13671           | Male Q.C., 16-14 Gauge   |
| 13672           | Female Q.C., 16-14 Gauge |
| 13673           | Male, Q.C., 16-14 Gauge  |
| 13674           | Ring Type, 12-10 Gauge   |
| 13675           | Ring Type, 12-10 Gauge   |
| 13676           | Ring Type, 12-10 Gauge   |
| 13678           | Butt Conn., 12-10 Gauge  |
| 13679           | Female Q.C., 12-10 Gauge |
| 13680           | Male Q.C., 12-10 Gauge   |
| 13681           | Female Plug, 16-14 Gauge |
| 13682           | Male Plug, 16-14 Gauge   |



**21471**  
Oil Drain Plugs & Gaskets  
12 Varieties - 24 Pieces



| Auveco Part No. | Size             |
|-----------------|------------------|
| 14196           | 1/2"-20 x 1/2"   |
| 18373           | 1/2"-20 x 13/16" |
| 18374           | M12-1.75 x 21mm  |
| 21047           | M12-1.75 x 25mm  |
| 14677           | M12-1.75 x 26mm  |
| 16308           | M14-1.5 x 11mm   |
| 18375           | M14-1.5 x 18mm   |
| 14678           | M14-1.5 x 20mm   |
| 19141           | M14-1.5 x 20mm   |
| 19279           | M14-1.5 x 20mm   |
| 19773           | M14-1.5 x 20mm   |
| 15529           | M18-1.5 x 12mm   |

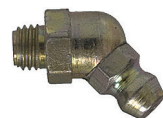

**19444**  
Metric Grease Fittings  
Plated  
12 Varieties - 89 Pieces



| Auveco Part No. | Type                 |
|-----------------|----------------------|
| 11097           | 6mm-1.00, Straight   |
| 11775           | 6mm-1.00, 45 Degree  |
| 11776           | 6mm-1.00, 90 Degree  |
| 11098           | 8mm-1.00, Straight   |
| 11777           | 8mm-1.00, 45 Degree  |
| 11099           | 8mm-1.00, 90 Degree  |
| 11778           | 8mm-1.25, Straight   |
| 11779           | 8mm-1.25, 45 Degree  |
| 11780           | 8mm-1.25, 90 Degree  |
| 11100           | 10mm-1.00, Straight  |
| 15067           | 10mm-1.00, 45 Degree |
| 11101           | 10mm-1.00, 90 Degree |



**19443**  
U.S. Grease Fittings  
Plated  
12 Varieties - 92 Pieces



| Auveco Part No. | Type                               |
|-----------------|------------------------------------|
| 9257            | 1/4"-28, Straight (Short)          |
| 9258            | 1/4"-28, Straight (Long)           |
| 9259            | 1/4"-28, Straight (Extra-Long)     |
| 9260            | 1/4"-28, 45 Degree                 |
| 9261            | 1/4"-28, 90 Degree                 |
| 9262            | 1/8" Pipe, Straight (Short)        |
| 9267            | 1/8" Pipe, Straight (Long)         |
| 15066           | 1/8" Pipe, Straight (Self-Tapping) |
| 9264            | 1/8" Pipe, 45 Degree               |
| 9265            | 1/8" Pipe, 65 Degree               |
| 9266            | 1/8" Pipe, 90 Degree               |
| 15059           | 1/4" Pipe, Straight                |



**17359**  
Door Hinge Bushings  
8 Varieties - 136 Pieces



| Auveco Part No. | Application |
|-----------------|-------------|
| 14548           | GM          |
| 14549           | GM          |
| 14550           | GM, Ford    |
| 14551           | Ford        |
| 14552           | Chrysler    |
| 14553           | GM          |
| 16936           | GM          |
| 16937           | GM          |



**19927**  
Copper Washers  
6 Varieties - 150 Pieces

| Auveco Part No. | Bolt Size | Outer Diameter |
|-----------------|-----------|----------------|
| 15915           | 1/4"      | 11/16"         |
| 15913           | 5/16"     | 9/16"          |
| 15916           | 5/16"     | 3/4"           |
| 15917           | 3/8"      | 13/16"         |
| 15918           | 7/16"     | 7/8"           |
| 15919           | 1/2"      | 13/16"         |



**17358**  
GM Door Hinge Pins  
5 Varieties - 27 Pieces

Contains the following Auveco part numbers:  
14559, 17437, 19183, 19424 & 19781

# "FP" 4 PACK ASSORTMENTS

Photos not actual size



The Auveco "FP" 4 pack assortments are packed in a four compartment easy open translucent polypropylene box. Each assortment contains four carefully selected items designed for the customer that requires maximum coverage for minimum investment.

## "FP" 4 Pack Numeric Listing

Refer to contents listing on following pages

| Auveco Part No. | Description                               |
|-----------------|---|
| FP-100          | Phillips Oval Head Tapping Screws, Chrome |
| FP-102          | Phillips Oval Head Tapping Screws, Chrome |
| FP-104          | Phillips Oval Head Tapping Screws, Chrome |
| FP-108          | Phillips Oval Head Tapping Screws, Chrome |
| FP-123          | Phillips Oval Head Sems® Screws, Chrome   |
| FP-131          | Hex Washer Head Tapping Screws            |
| FP-132          | Hex Washer Head Tapping Screws            |
| FP-159          | Washer Lock Nuts                          |
| FP-160          | Thread Cutting Nuts                       |
| FP-163          | Tubular Nuts                              |
| FP-164          | Tubular Nuts                              |
| FP-168          | J & U Nuts                                |
| FP-169          | J-Type Cage Nuts                          |
| FP-171          | Flat Washers                              |

| Auveco Part No. | Description  |
|-----------------|--|
| FP-178          | Shims  |
| FP-179          | Shims  |
| FP-183          | Cotter Pins  |
| FP-188          | Plug Buttons   |
| FP-193          | Grease Fittings  |
| FP-194          | Grease Fittings  |
| FP-210          | Universal Moulding Fasteners                           |
| FP-224          | Phillips Oval Head Tapping Screws, B. Oxide            |
| FP-232          | Phillips Oval Head Sems® Screws, Phos.                 |
| FP-233          | Phillips Flat Washer Head Tapping Screws, Black E-Coat |
| FP-243          | Push-On Retainers                                      |
| FP-247          | Spring Type U-Nuts                                     |

 **FP-100** Phillips Oval Head Tapping Screws Chrome 150 Pieces

| Auveco Part No. | Size       |
|-----------------|------------|
| 1794            | 6 x 3/4"   |
| 2698            | 6 x 1/2"   |
| 1796            | 6 x 1"     |
| 1797            | 6 x 1-1/4" |

 **FP-108** Phillips Oval Head Tapping Screws No. 8 Head - Chrome 115 Pieces

| Auveco Part No. | Size        |
|-----------------|-------------|
| 2724            | 10 x 5/8"   |
| 1717            | 10 x 3/4"   |
| 2730            | 10 x 1"     |
| 2734            | 10 x 1-1/4" |

 **FP-102** Phillips Oval Head Tapping Screws Chrome 140 Pieces

| Auveco Part No. | Size       |
|-----------------|------------|
| 2707            | 8 x 1/2"   |
| 2710            | 8 x 3/4"   |
| 2713            | 8 x 1"     |
| 2716            | 8 x 1-1/4" |

 **FP-224** Phillips Oval Head Tapping Screws Black Oxide 245 Pieces

| Auveco Part No. | Size       |
|-----------------|------------|
| 10163           | 8 x 1/2"   |
| 10165           | 8 x 3/4"   |
| 10167           | 8 x 1"     |
| 10169           | 8 x 1-1/4" |

 **FP-104** Phillips Oval Head Tapping Screws No. 6 Head - Chrome 130 Pieces

| Auveco Part No. | Size       |
|-----------------|------------|
| 2027            | 8 x 1/2"   |
| 1799            | 8 x 3/4"   |
| 1483            | 8 x 1"     |
| 1423            | 8 x 1-1/4" |

 **FP-123** Phillips Oval Head Sems® Tapping Screws Chrome 90 Pieces

| Auveco Part No. | Size      |
|-----------------|-----------|
| 2771            | 8 x 5/8"  |
| 2751            | 8 x 3/4"  |
| 2772            | 8 x 1"    |
| 3466            | 10 x 3/4" |

*Photos not actual size*



**FP-232**

Phillips Oval Head Sems® Tapping Screws  
Black Phosphate  
100 Pieces

| Auveco Part No. | Size      |
|-----------------|-----------|
| 11788           | 8 x 3/4"  |
| 11789           | 8 x 1"    |
| 11791           | 10 x 3/4" |
| 11792           | 10 x 1"   |



**FP-233**

Phillips Flat Washer Head Tapping Screws  
Black E-Coat  
220 Pieces

| Auveco Part No. | Size     |
|-----------------|----------|
| 12213           | 8 x 1/2" |
| 12214           | 8 x 5/8" |
| 12215           | 8 x 3/4" |
| 12216           | 8 x 1"   |

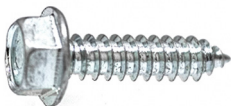

**FP-131**

Hex Washer Head Tapping Screws  
Zinc  
165 Pieces

| Auveco Part No. | Size      |
|-----------------|-----------|
| 2369            | 10 x 1/2" |
| 2809            | 10 x 5/8" |
| 2967            | 12 x 5/8" |
| 2968            | 12 x 3/4" |



**FP-132**

Hex Washer Head Tapping Screws  
Zinc  
75 Pieces

| Auveco Part No. | Size         |
|-----------------|--------------|
| 2370            | 14 x 5/8"    |
| 2330            | 14 x 3/4"    |
| 2974            | 14 x 1"      |
| 2978            | 5/16" x 3/4" |



**FP-243**

Push-On Retainers  
Zinc  
260 Pieces

| Auveco Part No. | Stud Size | Outer Diameter |
|-----------------|-----------|----------------|
| 8863            | 1/8"      | 3/8"           |
| 8865            | 3/16"     | 7/16"          |
| 8868            | 1/4"      | 17/32"         |
| 8869            | 5/16"     | 5/8"           |



**FP-159**

Washer Lock Nuts  
Zinc  
240 Pieces

| Auveco Part No. | Thread Size | Outer Diameter |
|-----------------|-------------|----------------|
| 2555            | 8-32        | 15/32"         |
| 2556            | 10-32       | 1/2"           |
| 2557            | 10-24       | 1/2"           |
| 2558            | 10-24       | 3/4"           |



**FP-160**

Thread Cutting Nuts  
Zinc  
125 Pieces

| Auveco Part No. | Stud Size | O.D.   |
|-----------------|-----------|--------|
| 3403            | 1/8"      | 7/16"  |
| 2895            | 1/8"      | 17/32" |
| 2896            | 3/16"     | 5/8"   |
| 2897            | 1/4"      | 19/32" |



**FP-168**

J and U-Type Nuts  
48 Pieces

| Auveco Part No. | Screw Size |
|-----------------|------------|
| 1907            | 5/16"-10   |
| 2057            | #14        |
| 2420            | #14        |
| 2293            | 1/4"-20    |



**FP-169**

J-Type Cage Nuts  
28 Pieces

| Auveco Part No. | Thread Size |
|-----------------|-------------|
| 5589            | 5/16"-18    |
| 5170            | 3/8"-16     |
| 5586            | 1/4"-20     |



**FP-163**

Tubular Nuts  
80 Pieces

| Auveco Part No. | Stud Size |
|-----------------|-----------|
| 2611            | 1/8"      |
| 11293           | 1/8"      |
| 3776            | 3/32"     |
| 2565            | 3/16"     |

# "FP" 4 PACK ASSORTMENTS

Photos not actual size

**Sec. 15**



**FP-164**  
Tubular Nuts  
75 Pieces

| Auveco Part No. | Stud Size |
|-----------------|-----------|
| 2595            | 1/8"      |
| 3137            | 3/32"     |
| 10073           | 3/16"     |
| 5196            | 1/4"      |



**FP-247**  
Spring Type U-Nuts  
Phosphate  
70 Pieces

| Auveco Part No. | Screw Size |
|-----------------|------------|
| 10064           | #6         |
| 10065           | #8         |
| 10066           | #10        |
| 10067           | #14        |



**FP-171**  
Fender Washers  
Zinc Plated  
200 Pieces

| Auveco Part No. | Bolt Size | Outer Diameter |
|-----------------|-----------|----------------|
| 1183            | 3/16"     | 3/4"           |
| 2333            | 1/4"      | 1-1/4"         |
| 768             | 5/16"     | 1-1/4"         |
| 3553            | 3/8"      | 1-1/4"         |



**FP-210**  
Universal Moulding  
Fasteners with Nuts  
18 Moulding Fasteners

Contains the following Auveco Part Numbers:  
**2818, 2619, 2752 & 19626.**



**FP-178**  
Shims - Plated  
75 Pieces

| Auveco Part No. | Size            | Thickness | Slot |
|-----------------|-----------------|-----------|------|
| 3155            | 1-1/4" x 1-1/8" | 1/16"     | 3/8" |
| 3156            | 1-1/4" x 1-1/8" | 1/8"      | 3/8" |
| 2452            | 1-3/4" x 1-1/4" | 1/16"     | 1/2" |
| 2453            | 1-3/4" x 1-1/4" | 1/8"      | 1/2" |



**FP-179**  
Caster & Camber Shims  
Plated  
65 Pieces

| Auveco Part No. | Thickness | Size            |
|-----------------|-----------|-----------------|
| 5074            | 1/64"     | 1-1/8" x 1-1/8" |
| 5075            | 1/32"     | 1-1/8" x 1-1/8" |
| 5076            | 1/16"     | 1-1/8" x 1-1/8" |
| 5077            | 1/8"      | 1-1/8" x 1-1/8" |



**FP-183**  
Hammer Lock  
Cotter Pins  
Plated  
240 Pieces

| Auveco Part No. | Size           |
|-----------------|----------------|
| 8482            | 3/32" x 1"     |
| 8484            | 3/32" x 1-1/2" |
| 8488            | 1/8" x 1-1/2"  |
| 8490            | 1/8" x 2"      |



**FP-188**  
Plug Buttons  
Nickel Plated  
37 Pieces

| Auveco Part No. | Hole Size |
|-----------------|-----------|
| 3751            | 3/8"      |
| 3752            | 1/2"      |
| 3753            | 5/8"      |
| 3755            | 7/8"      |



**FP-193**  
Ball Check Grease Fittings  
34 Pieces

| Auveco Part No. | Size               |
|-----------------|--------------------|
| 9257            | 1/4"-28 Short      |
| 9258            | 1/4"-28 Long       |
| 9259            | 1/4"-28 Extra Long |
| 9262            | 1/8" Pipe Thread   |

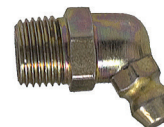

**FP-194**  
Ball Check  
Grease Fittings  
22 Pieces

| Auveco Part No. | Size      | Type |
|-----------------|-----------|------|
| 9260            | 1/4"-28   | 45°  |
| 9261            | 1/4"-28   | 90°  |
| 9264            | 1/8" Pipe | 45°  |
| 9265            | 1/8" Pipe | 65°  |



# O-RING ASSORTMENTS

*Photos not actual size*



## 18885

Air Conditioning Nitrile O-Rings  
**For use with R134A & R12 refrigerant**  
 18 Varieties - 203 Pieces

| Auveco Part No. | Inner Diameter | Outer Diameter | Thickness |
|-----------------|----------------|----------------|-----------|
| 17604           | .290"          | .432"          | .071"     |
| 18646           | 3/8"           | 1/2"           | 1/16"     |
| 17605           | .400"          | .546"          | .073"     |
| 17606           | .509"          | .655"          | .073"     |
| 17607           | .617"          | .769"          | .076"     |
| 18647           | 11/16"         | 13/16"         | 1/16"     |
| 18134           | 4.5mm          | 7.3mm          | 1.4mm     |
| 18135           | 6mm            | 9.6mm          | 1.8mm     |
| 18136           | 6.5mm          | 9.5mm          | 1.5mm     |
| 18137           | 6.6mm          | 10.2mm         | 1.8mm     |
| 18138           | 7.7mm          | 11.3mm         | 1.8mm     |
| 18140           | 10.7mm         | 15.5mm         | 2.4mm     |
| 18139           | 10.8mm         | 14.4mm         | 1.8mm     |
| 18141           | 13.3mm         | 18.1mm         | 2.4mm     |
| 18143           | 13.4mm         | 17.2mm         | 1.9mm     |
| 18142           | 14mm           | 17.6mm         | 1.8mm     |
| 18144           | 14.8mm         | 19.6mm         | 2.4mm     |
| 19235           | 13/16"         | 1-1/16"        | 1/8"      |



## 21845

Air Conditioning O-Rings  
 Blue Neoprene (Teflon Coated)  
**For use with R134A & R12 Refrigerant**  
 6 Varieties - 325 Pieces

| Auveco Part No. | Industry Standard | Inner Diameter | Outer Diameter | Thickness |
|-----------------|-------------------|----------------|----------------|-----------|
| 18533           | 108               | 1/4"           | 7/16"          | 3/32"     |
| 18534           | 011               | 5/16"          | 7/16"          | 1/16"     |
| 18536           | 110               | 3/8"           | 9/16"          | 3/32"     |
| 18537           | 013               | 7/16"          | 9/16"          | 1/16"     |
| 18539           | 112               | 1/2"           | 11/16"         | 3/32"     |
| 18543           | 017               | 11/16"         | 13/16"         | 1/16"     |

# BUNA-N RUBBER O-RINGS

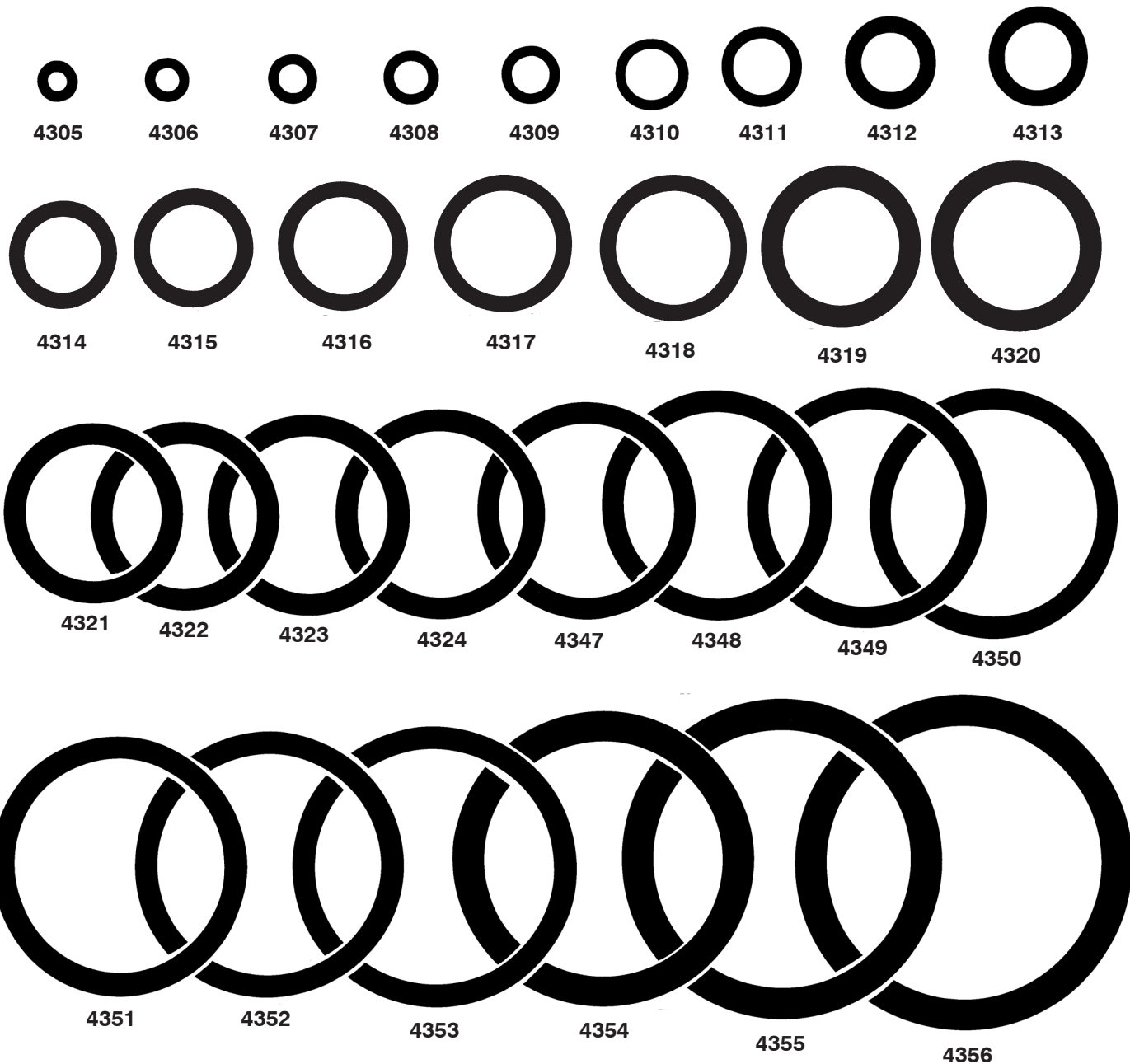

| Auveco Part No. | Thickness |
|-----------------|-----------|
| 4305 thru 4311  | 1/16"     |
| 4312 thru 4318  | 3/32"     |
| 4319 thru 4353  | 1/8"      |
| 4354 thru 4356  | 13/64"    |

Temperature Rating: 70 hours at 100°C

| Auveco Part No. | Ind. Std. | I.D.  | O.D.   | Unit Pkg. |
|-----------------|-----------|-------|--------|-----------|
| 4305            | 006       | 1/8"  | 1/4"   | 50        |
| 4306            | 007       | 5/32" | 9/32"  | 50        |
| 4307            | 008       | 3/16" | 5/16"  | 50        |
| 4308            | 009       | 7/32" | 11/32" | 50        |
| 4309            | 010       | 1/4"  | 3/8"   | 50        |
| 4310            | 011       | 5/16" | 7/16"  | 50        |
| 4311            | 012       | 3/8"  | 1/2"   | 50        |
| 4312            | 110       | 3/8"  | 9/16"  | 50        |
| 4313            | 111       | 7/16" | 5/8"   | 50        |
| 4314            | 112       | 1/2"  | 11/16" | 50        |
| 4315            | 113       | 9/16" | 3/4"   | 50        |

| Auveco Part No. | Ind. Std. | I.D.    | O.D.     | Unit Pkg. |
|-----------------|-----------|---------|----------|-----------|
| 4316            | 114       | 5/8"    | 13/16"   | 50        |
| 4317            | 115       | 11/16"  | 7/8"     | 50        |
| 4318            | 116       | 3/4"    | 15/16"   | 50        |
| 4319            | 210       | 3/4"    | 1"       | 50        |
| 4320            | 211       | 13/16"  | 1-1/16"  | 50        |
| 4321            | 212       | 7/8"    | 1-1/8"   | 50        |
| 4322            | 213       | 15/16"  | 1-3/16"  | 50        |
| 4323            | 214       | 1"      | 1-1/4"   | 50        |
| 4324            | 215       | 1-1/16" | 1-5/16"  | 50        |
| 4347            | 216       | 1-1/8"  | 1-3/8"   | 25        |
| 4348            | 217       | 1-3/16" | 1-7/16"  | 25        |
| 4349            | 218       | 1-1/4"  | 1-1/2"   | 25        |
| 4350            | 219       | 1-5/16" | 1-9/16"  | 25        |
| 4351            | 220       | 1-3/8"  | 1-5/8"   | 25        |
| 4352            | 221       | 1-7/16" | 1-11/16" | 25        |
| 4353            | 222       | 1-1/2"  | 1-3/4"   | 25        |
| 4354            | 325       | 1-1/2"  | 1-7/8"   | 25        |
| 4355            | 326       | 1-5/8"  | 2"       | 25        |
| 4356            | 327       | 1-3/4"  | 2-1/8"   | 25        |

# Sec. 16

# METRIC BUNA-N RUBBER O-RINGS

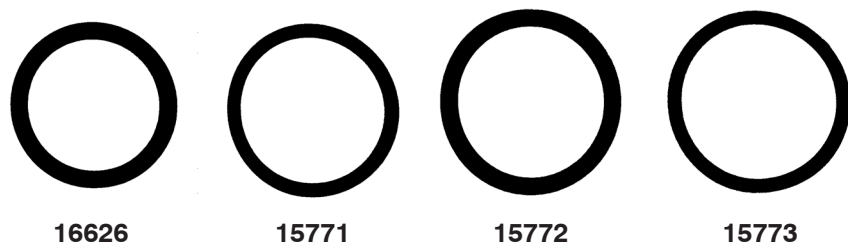
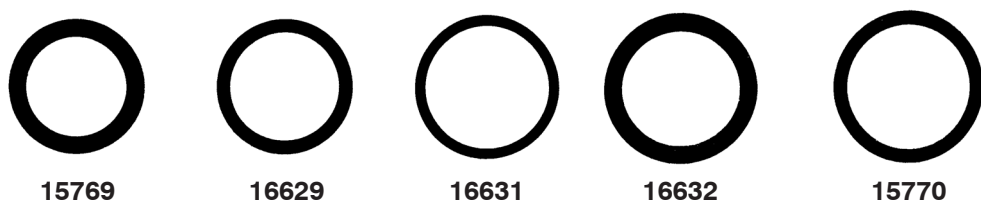
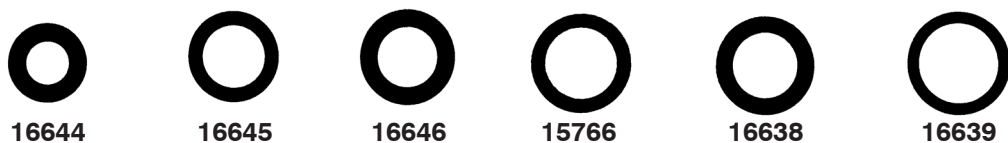

| Auveco Part No. | Inner Diameter | Outer Diameter | Thickness | Unit Pkg. |
|-----------------|----------------|----------------|-----------|-----------|
| 16647           | 2.2mm          | 5.4mm          | 1.6mm     | 50        |
| 16648           | 3.1mm          | 6.3mm          | 1.6mm     | 50        |
| 16649           | 4.1mm          | 7.3mm          | 1.6mm     | 50        |
| 15764           | 4mm            | 8mm            | 2mm       | 100       |
| 16650           | 5mm            | 8mm            | 1.5mm     | 50        |
| 15765           | 6mm            | 10mm           | 2mm       | 100       |
| 16642           | 5.3mm          | 10.1mm         | 2.4mm     | 50        |
| 16643           | 7.1mm          | 10.3mm         | 1.6mm     | 50        |
| 16644           | 5.6mm          | 10.4mm         | 2.4mm     | 50        |
| 16645           | 8mm            | 12mm           | 2mm       | 50        |
| 16646           | 7.6mm          | 12.4mm         | 2.4mm     | 50        |
| 15766           | 9mm            | 13mm           | 2mm       | 100       |
| 16638           | 8.3mm          | 13.1mm         | 2.4mm     | 50        |
| 16639           | 10.1mm         | 13.3mm         | 1.6mm     | 50        |
| 16640           | 8.6mm          | 13.4mm         | 2.4mm     | 50        |

| Auveco Part No. | Inner Diameter | Outer Diameter | Thickness | Unit Pkg. |
|-----------------|----------------|----------------|-----------|-----------|
| 15767           | 10mm           | 15mm           | 2.5mm     | 100       |
| 16634           | 10mm           | 16mm           | 3mm       | 50        |
| 15768           | 12mm           | 16mm           | 2mm       | 100       |
| 16635           | 13mm           | 16mm           | 1.5mm     | 50        |
| 16636           | 11mm           | 17mm           | 3mm       | 50        |
| 15769           | 13mm           | 18mm           | 2.5mm     | 100       |
| 16629           | 14mm           | 18mm           | 2mm       | 50        |
| 16631           | 16mm           | 19mm           | 1.5mm     | 50        |
| 16632           | 15mm           | 20mm           | 2.5mm     | 50        |
| 15770           | 16mm           | 20mm           | 2mm       | 50        |
| 16626           | 17mm           | 22mm           | 2.5mm     | 25        |
| 15771           | 19mm           | 23mm           | 2mm       | 50        |
| 15772           | 19mm           | 24mm           | 2.5mm     | 50        |
| 15773           | 20mm           | 24mm           | 2mm       | 50        |

# O-RINGS

## Air Conditioning O-Rings

For use with R12 Refrigerant only

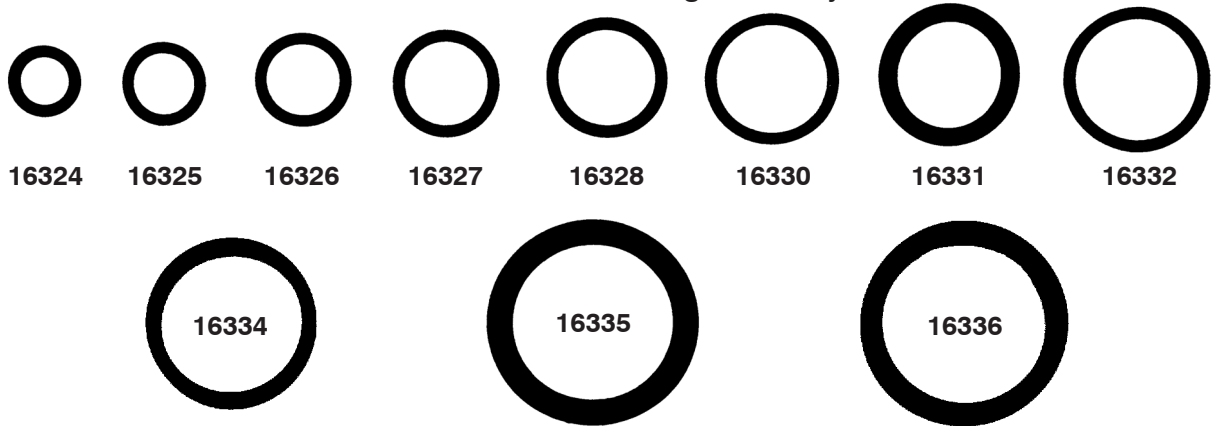

For original air conditioning systems. Not for use with R134A refrigerant.

| Auveco Part No. | Ind. Std. | I.D.  | O.D.   | Thick-ness | Unit Pkg. | Auveco Part No. | Ind. Std. | I.D.   | O.D.    | Thick-ness | Unit Pkg. |
|-----------------|-----------|-------|--------|------------|-----------|-----------------|-----------|--------|---------|------------|-----------|
| 16324           | 010       | 1/4"  | 3/8"   | 1/16"      | 50        | 16331           | 113       | 9/16"  | 3/4"    | 3/32"      | 25        |
| 16325           | 011       | 5/16" | 7/16"  | 1/16"      | 50        | 16332           | 016       | 5/8"   | 3/4"    | 1/16"      | 50        |
| 16326           | 012       | 3/8"  | 1/2"   | 1/16"      | 50        | 16334           | 018       | 3/4"   | 7/8"    | 1/16"      | 25        |
| 16327           | 013       | 7/16" | 9/16"  | 1/16"      | 50        | 16335           | 211       | 13/16" | 1-1/16" | 1/8"       | 10        |
| 16328           | 014       | 1/2"  | 5/8"   | 1/16"      | 50        | 16336           | 118       | 7/8"   | 1-1/16" | 3/32"      | 25        |
| 16330           | 015       | 9/16" | 11/16" | 1/16"      | 50        |                 |           |        |         |            |           |

## Nitrile Air Conditioning O-Rings

For use with R12 & R134A Refrigerant

These O-Rings are either green or black with an orange dot.

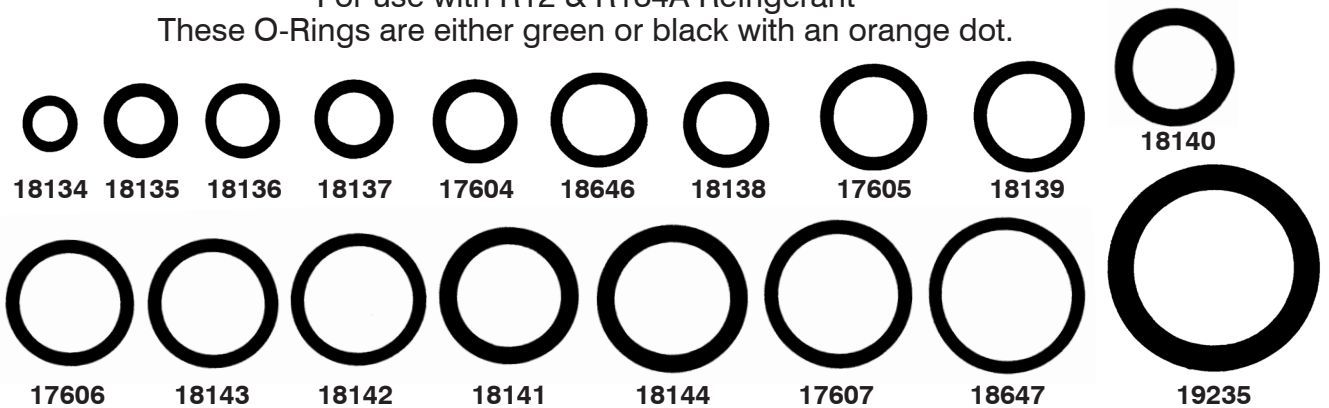

| Auveco Part No. | I.D.   | O.D.    | Thickness | OEM No.                                     | Unit Pkg. |
|-----------------|--------|---------|-----------|---|-----------|
| 18134           | 4.5mm  | 7.3mm   | 1.4mm     | Nissan: 92472-N8200                         | 25        |
| 18135           | 6mm    | 9.6mm   | 1.8mm     | Nissan: 92470-N8200                         | 25        |
| 18136           | 6.5mm  | 9.5mm   | 1.5mm     | Toyota: 90099-14044                         | 25        |
| 18137           | 6.6mm  | 10.2mm  | 1.8mm     | Acura: 80873-ST7-000                        | 25        |
| 17604           | .290"  | .432"   | .071"     | Ford: 391396                                | 25        |
| 18138           | 7.7mm  | 11.3mm  | 1.8mm     | Nissan: 92474-N8200                         | 25        |
| 18646           | .375"  | .500"   | .063"     |   | 25        |
| 17605           | .400"  | .546"   | .073"     | Ford: 391397                                | 25        |
| 18139           | 10.8mm | 14.4mm  | 1.8mm     | Nissan: 92471-N8200                         | 25        |
| 18140           | 10.7mm | 15.5mm  | 2.4mm     | Acura: 80872-ST7-000<br>Nissan: 92475-W1000 | 25        |
| 17606           | .509"  | .655"   | .073"     | Ford: 391304                                | 25        |
| 18143           | 13.4mm | 17.2mm  | 1.9mm     | Toyota: 90099-14045                         | 15        |
| 18142           | 14mm   | 17.6mm  | 1.8mm     | Nissan: 92473-N8200                         | 25        |
| 18141           | 13.3mm | 18.1mm  | 2.4mm     | Acura: 80871-ST7-000                        | 25        |
| 18144           | 14.8mm | 19.6mm  | 2.4mm     | Nissan: 92475-W2100                         | 15        |
| 17607           | .617"  | .769"   | .076"     | Ford: 391305                                | 15        |
| 18647           | .688"  | .813"   | .063"     |   | 25        |
| 19235           | 13/16" | 1-1/16" | 1/8"      |   | 10        |

**Blue Neoprene Air Conditioning O-Rings**

Teflon Coated • For use with R134A & R12 Refrigerant



18533



18534



18535



18536



18537



18539



18540

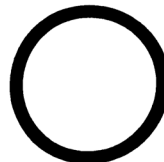

18543

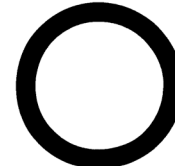

19666

| Auveco Part No. | Industry Standard | Inner Diameter | Outer Diameter | Thickness | Unit Pkg. |
|-----------------|-------------------|----------------|----------------|-----------|-----------|
| 18533           | 108               | 1/4"           | 7/16"          | 3/32"     | 25        |
| 18534           | 011               | 5/16"          | 7/16"          | 1/16"     | 25        |
| 18536           | 110               | 3/8"           | 9/16"          | 3/32"     | 25        |
| 18537           | 013               | 7/16"          | 9/16"          | 1/16"     | 25        |
| 18539           | 112               | 1/2"           | 11/16"         | 3/32"     | 25        |
| 18540           | 015               | 9/16"          | 11/16"         | 1/16"     | 25        |
| 18543           | 017               | 11/16"         | 13/16"         | 1/16"     | 25        |
| 19666           | 115               | 11/16"         | 7/8"           | 3/32"     | 25        |

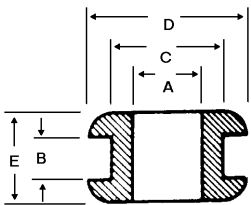

**Rubber Grommet**

Made of SBR Material • Durometer Hardness 60



UNIT PACKAGE: 25

| Auveco Part No. | A Bore Dia. | B Groove Width | C Groove Dia. | D Outside Dia. | E Overall Thickness |
|-----------------|-------------|----------------|---------------|----------------|---------------------|
| 4408            | 1/8"        | 3/32"          | 3/8"          | 1/2"           | 5/16"               |
| 4410            | 5/32"       | 1/16"          | 1/4"          | 3/8"           | 3/16"               |
| 4411            | 5/32"       | 3/32"          | 1/4"          | 7/16"          | 3/8"                |
| 4413            | 3/16"       | 1/16"          | 5/16"         | 1/2"           | 1/4"                |
| 4414            | 3/16"       | 3/32"          | 9/32"         | 3/8"           | 5/16"               |
| 4415            | 3/16"       | 1/4"           | 5/16"         | 7/16"          | 3/8"                |
| 16454           | 1/4"        | 1/16"          | 3/8"          | 1/2"           | 3/16"               |
| 4417            | 1/4"        | 1/16"          | 7/16"         | 5/8"           | 3/16"               |
| 4418            | 1/4"        | 1/16"          | 1"            | 1-1/4"         | 1/4"                |
| 4419            | 5/16"       | 1/16"          | 7/16"         | 9/16"          | 3/16"               |
| 4420            | 5/16"       | 1/16"          | 9/16"         | 13/16"         | 5/16"               |
| 16455           | 5/16"       | 1/16"          | 3/4"          | 1"             | 5/16"               |
| 4421            | 5/16"       | 1/8"           | 9/16"         | 13/16"         | 3/8"                |
| 4422            | 5/16"       | 1/4"           | 9/16"         | 13/16"         | 1/2"                |
| 4423            | 3/8"        | 1/16"          | 1/2"          | 11/16"         | 9/32"               |

| Auveco Part No. | A Bore Dia. | B Groove Width | C Groove Dia. | D Outside Dia. | E Overall Thickness |
|-----------------|-------------|----------------|---------------|----------------|---------------------|
| 16456           | 3/8"        | 1/16"          | 5/8"          | 7/8"           | 11/32"              |
| 4425            | 3/8"        | 1/16"          | 1"            | 1-1/4"         | 1/4"                |
| 4426            | 3/8"        | 1/4"           | 5/8"          | 7/8"           | 1/2"                |
| 16457           | 7/16"       | 1/16"          | 9/16"         | 3/4"           | 1/4"                |
| 4428            | 1/2"        | 3/32"          | 3/4"          | 31/32"         | 9/32"               |
| 4429            | 1/2"        | 3/32"          | 25/32"        | 1"             | 11/32"              |
| 16458           | 1/2"        | 1/8"           | 3/4"          | 1"             | 1/2"                |
| 4430            | 1/2"        | 1/4"           | 13/16"        | 1-1/16"        | 1/2"                |
| 4431            | 5/8"        | 1/8"           | 7/8"          | 1-1/8"         | 3/8"                |
| 4432            | 5/8"        | 1/16"          | 7/8"          | 1-1/8"         | 5/16"               |
| 4433            | 3/4"        | 1/16"          | 15/16"        | 1-1/8"         | 1/4"                |
| 4434            | 3/4"        | 1/16"          | 1-1/16"       | 1-3/8"         | 3/8"                |
| 4435            | 3/4"        | 1/16"          | 1-1/4"        | 1-5/8"         | 1/4"                |
| 4436            | 3/4"        | 1/4"           | 1-1/4"        | 1-5/8"         | 7/16"               |

## Vinyl Grommet

- Black Vinflex 163
- Exceptional Aging Qualities
- High Dielectric Properties
- Oil Resistant
- Non-Conductive
- Durometer Hardness 60
- Excellent Resistance to
- Ozone and Sunlight

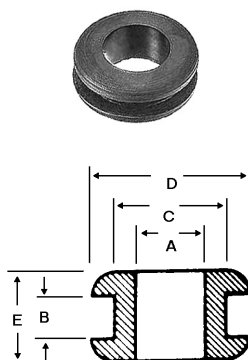

**14765**

- “A” Bore Diameter: 5/16”
- “B” Groove Width: 1/16”
- “C” Groove Diameter: 7/16”
- “D” Outside Diameter: 5/8”
- “E” Overall Thickness: 1/4”

UNIT PACKAGE: 50

## Tubeless Tire Valves



Length: 1-1/4”  
Rim Hole: 29/64”  
(TR413)

**10184**  
UNIT PACKAGE: 5

**10191**  
UNIT PACKAGE: 25

**10192**  
UNIT PACKAGE: 100

## PICKUP TRUCK CAP WEATHERSTRIP TAPE

*Photo not actual size*



Closed-cell foam weatherstrip tape. Used on the bottom lip of the cap or the truck’s flange to form a moisture, dust and vibration resistant seal. Features an aggressive acrylic adhesive.

**Exact Size Profile**



**20922**  
Light Gray

1-1/4” Width x 30 Ft. Length  
Thickness: 3/16”

UNIT PACKAGE: 1 Roll

**Sec. 16**

**SPONGE WEATHERSTRIPS**

Peel-Bak Adhesive Neoprene Sponge Weatherstrip

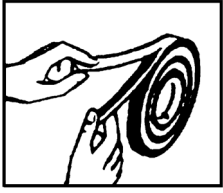

Peel back liner.



Press on clean dry surface

Peel-Bak is a light-weight closed cell sponge material. It is an easy to apply weatherstrip for auto and household use.

Can also be used on boats, refrigerators or any place a weatherproof, permanent seal is required.

Simple to use: Peel back the liner tape and press into place. No cement or tacking required. Surface must be clean and dry.

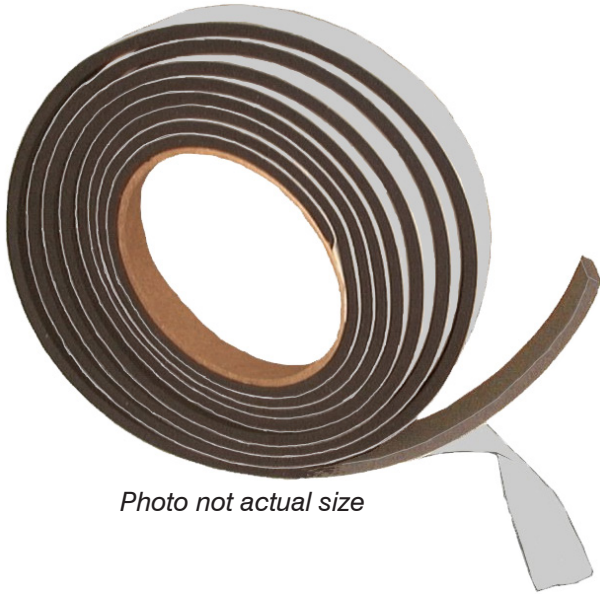
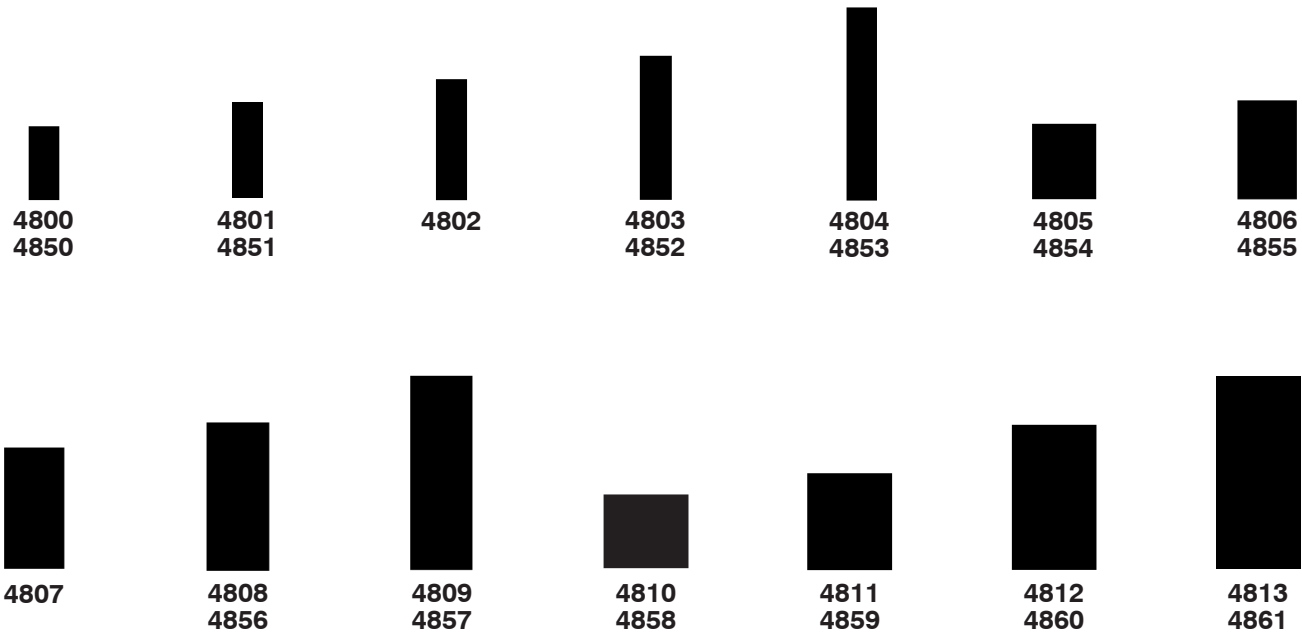

Photo not actual size

| Thickness | Width | 10 Ft. Roll<br>Auveco<br>Part No. | 50 Ft. Roll<br>Auveco<br>Part No. |
|-----------|-------|-----------------------------------|-----------------------------------|
| 5/32"     | 3/8"  | <b>4800</b>                       | <b>4850</b>                       |
| 5/32"     | 1/2"  | <b>4801</b>                       | <b>4851</b>                       |
| 5/32"     | 5/8"  | <b>4802</b>                       | <b>4852</b>                       |
| 5/32"     | 3/4"  | <b>4803</b>                       | <b>4853</b>                       |
| 5/32"     | 1"    | <b>4804</b>                       | <b>4853</b>                       |
| 5/16"     | 3/8"  | <b>4805</b>                       | <b>4854</b>                       |
| 5/16"     | 1/2"  | <b>4806</b>                       | <b>4855</b>                       |
| 5/16"     | 5/8"  | <b>4807</b>                       | <b>4856</b>                       |
| 5/16"     | 3/4"  | <b>4808</b>                       | <b>4856</b>                       |
| 5/16"     | 1"    | <b>4809</b>                       | <b>4857</b>                       |
| 7/16"     | 3/8"  | <b>4810</b>                       | <b>4858</b>                       |
| 7/16"     | 1/2"  | <b>4811</b>                       | <b>4859</b>                       |
| 7/16"     | 3/4"  | <b>4812</b>                       | <b>4860</b>                       |
| 7/16"     | 1"    | <b>4813</b>                       | <b>4861</b>                       |

**Exact Size Profile**



## PVC Foam Adhesive Weatherstrips

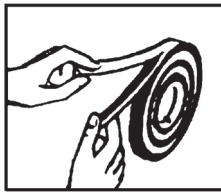

Peel back liner.

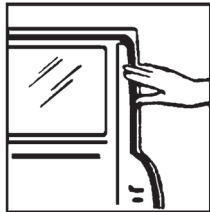

Press on clean dry surface

Low density, PVC (polyvinyl chloride) foam weatherstrip with a permanent acrylic adhesive for easy application even on irregular or curved surfaces. Seals out air, moisture, dust and light. It is also cushioning against vibration and noise. Remains flexible at -20° C to 80° C (-4° F to 176° F).

Color: Light Gray

Photo not actual size



| Thickness | Width | 10 Ft. Roll<br>Auveco<br>Part No. | 50 Ft. Roll<br>Auveco<br>Part No. |
|-----------|-------|-----------------------------------|-----------------------------------|
| 3/16"     | 1/2"  | <b>20912</b>                      |                                   |
| 5/16"     | 3/4"  | <b>20914</b>                      | <b>20915</b>                      |
| 5/16"     | 1"    | <b>20916</b>                      | <b>20917</b>                      |
| 7/16"     | 3/4"  | <b>20918</b>                      | <b>20919</b>                      |
| 7/16"     | 1"    | <b>20920</b>                      |                                   |

### Exact Size Profile

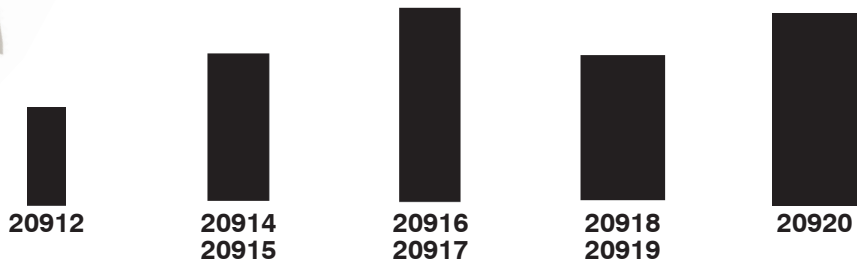

## Sponge Rubber Weatherstrips

EPDM Closed Cell • Light Weight • Weather Resistant

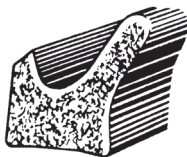

**16390**  
Door Flange  
Weatherstrip  
GM, Ford & Chrysler  
Cars & Trucks



UNIT PACKAGE: 15 Ft.

**4675**

Same as 16390 except for unit package quantity

UNIT PACKAGE: 50 Ft.



**16395**  
Trunk & Rear  
Deck Gutter  
Weatherstrip  
GM



UNIT PACKAGE: 15 Ft.

**4703**

Same as 16395 except for unit package quantity

UNIT PACKAGE: 50 Ft.



**4707**  
Door Flange  
Weatherstrip  
Chrysler 1954-50  
Ford 1958-50



UNIT PACKAGE: 50 Ft.



**4731**  
Door Flange Weatherstrip  
GM 1954-53  
Universal



UNIT PACKAGE: 50 Ft.

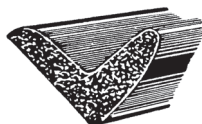

**4747**  
Door Inner Belt  
Weatherstrip  
All Cars 1970-55



UNIT PACKAGE: 50 Ft.



**16392**  
Door Flange  
Weatherstrip  
Ford 1955-On



UNIT PACKAGE: 15 Ft.

**4745**

Same as 16392 except for unit package quantity

UNIT PACKAGE: 50 Ft.



**Sec. 16**

**SPONGE RUBBER WEATHERSTRIPS**

EPDM Closed Cell • Light Weight • Weather Resistant

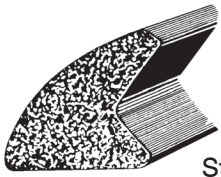

**4742**

Trunk & Lid  
Weatherstrip  
GM 1959 - On  
Ford 1949 - On  
Studebaker 1967 - 55



UNIT PACKAGE: 50 Ft.

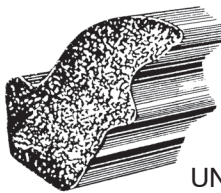

**16394**

Deck Lid  
Weatherstrip  
GM 1956 - On



UNIT PACKAGE: 15 Ft.

**4749**

Same as 16394 except for unit package quantity.

UNIT PACKAGE: 50 Ft.



**16391**

Door Flange Weatherstrip  
GM: 1955 - On



UNIT PACKAGE: 15 Ft.

**4744**

Same as 16391 except for unit package quantity.

UNIT PACKAGE: 50 Ft.

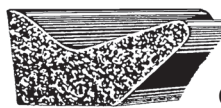

**16393**

Door Flange  
Weatherstrip  
Chrysler 1958 - On



UNIT PACKAGE: 15 Ft.

**4746**

Same as 16393 except for unit package quantity.

UNIT PACKAGE: 50 Ft.



**16890**

Door Flange  
Weatherstrip  
Ford 1956 - 53



UNIT PACKAGE: 25 Ft.

**16891**

Same as 16890 except for unit package quantity.

UNIT PACKAGE: 50 Ft.

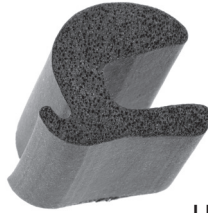

**4743**

Trunk  
Weatherstrip  
Universal



UNIT PACKAGE: 35 Ft.

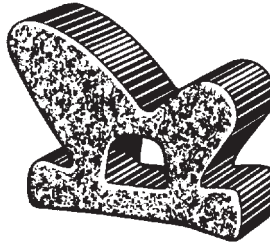

**16892**

Roof Rail Weatherstrip  
GM 1977 - 68



UNIT PACKAGE: 25 Ft.

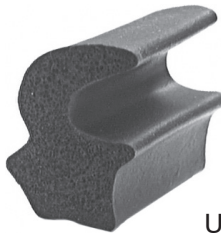

**4750**

(C5AZ-6243720-B)

Deck Lid  
Weatherstrip  
Ford 1956 - On



UNIT PACKAGE: 50 Ft.

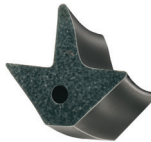

**20928**

Door Flange,  
Trunk & Tail Gate  
Weatherstrip  
Hole Diameter: 3/32"  
Universal



UNIT PACKAGE: 25 Ft.

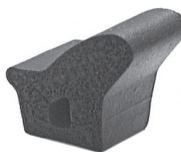

**16525**

Door Seal Weatherstrip  
GM 1963 - 55



UNIT PACKAGE: 50 Ft.

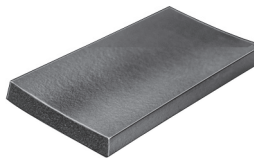

**Extruded Closed Cell  
Sponge Rubber**

Will not absorb water or moisture.  
Without Cement.

**19341**

Exact Size Profile

1/8" Thick -3/4" Wide

UNIT PACKAGE: 25 Ft.

**4740**

Exact Size Profile

1/8" Thick -1-1/2" Wide

UNIT PACKAGE: 25 Ft.

# SPONGE RUBBER WEATHERSTRIPS

EPDM Closed Cell • Light Weight • Weather Resistant

**Sec. 16**



## Closed Cell Half Round Sponge Rubber

UNIT PACKAGE: 50 Ft.



**4736**

1/4" Half Round



**4737**

3/8" Half Round



**4738**

1/2" Half Round



## Closed Cell Sponge Rubber Windlace Cord

Flexible filler for cloth covered windlace on door, windshield pillars and door bottoms.

UNIT PACKAGE: 50 Ft.



**4654**

1/4" Diameter



**4655**

3/8" Diameter



**4656**

1/2" Diameter

## RUBBER BUMPERS & GROMMETS



**4280**

(3745361, 3762180)

License Plate Bumper  
GM

UNIT PACKAGE: 25



**4260**

(17562)

Windshield Wiper Rubber Grommet  
Inner Diameter: 11/32"  
Outer Diameter: 5/8"  
Thickness: 3/16"  
Ford

UNIT PACKAGE: 25



**4246**

(357811)

Gas Tank Lid Rubber Bumper  
Ford

UNIT PACKAGE: 25



**4242**

(4137121)

Trunk, Rear Deck Lid, &  
Hood Bumper  
GM

UNIT PACKAGE: 25



**4243**

(513388)

Hood to Ledge Bumper  
GM

UNIT PACKAGE: 25



**4265**

(3711168)

Door Lock Striker Plate, Window Glass  
Stop & License Plate Bumper  
GM

UNIT PACKAGE: 25



**4188**

(4081765)

Door & Quarter Glass and  
Door Opening Header Bumper  
GM

UNIT PACKAGE: 25



**4237**

(3664645)

General Purpose  
GM

UNIT PACKAGE: 25

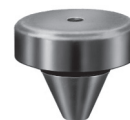

**4235**

(3688811)

Hood Top Panel Side  
Bumper to Fender  
GM

UNIT PACKAGE: 25



**4248**

(16758)

General Purpose  
Ford

UNIT PACKAGE: 25



**4258**  
(352839)

General Purpose  
Ford

UNIT PACKAGE: 25

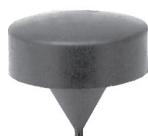

**4233**  
(3655015)

General Purpose  
GM

UNIT PACKAGE: 25



**4447**  
(7724826)

Trunk Lid Bumper  
GM

UNIT PACKAGE: 10



**4273**  
(B7A-16758-A)

Hood Bumper  
Ford

UNIT PACKAGE: 25



**13967**

General Purpose  
Outer Diameter: 1/2"  
Head Height: 5/16"  
Fits into 1/4" Hole  
Durometer: 55-65

UNIT PACKAGE: 25



**4369**  
(3900684, 15029828)

Pillar Bumper  
GM Trucks

UNIT PACKAGE: 25



**4446**  
(4872948)

Trunk Lid Bumper  
GM

UNIT PACKAGE: 25



**4249**  
(1304225)

General Purpose  
GM

UNIT PACKAGE: 25



**4264**  
(4564974)

Front Door Bumper  
GM

UNIT PACKAGE: 25



**4250**  
(3693292)

Glove Box Door Bumper  
GM

UNIT PACKAGE: 25



**4441**  
(4565591, 7637192)

Front Door Bumper  
GM

UNIT PACKAGE: 25



**4155**  
(16758A)

General Purpose  
Ford

UNIT PACKAGE: 25



**4357**  
(C60Z-16758-A)

Hood to Fender Bumper  
Ford

UNIT PACKAGE: 25



**4244**  
(972724)

General Purpose  
Chrysler

UNIT PACKAGE: 25



**4204**  
(4023030)

General Purpose  
Ford & Chrysler

UNIT PACKAGE: 25



**4240**  
(4563173, 4565415)

Door Bumper  
GM

UNIT PACKAGE: 25



**4236**  
(3689084)

General Purpose  
GM

UNIT PACKAGE: 25



**4281**  
(4721222)

Trunk Lid Bumper  
GM

UNIT PACKAGE: 25



**20698**  
Black Rubber

Cigarette Lighter Safety Plug  
Used to replace unwanted  
cigarette lighters. Prevents  
accidental shocks and burns.  
Discourages smoking in the car.  
The tight fit deters removal.

UNIT PACKAGE: 2



**15453**  
(472450, 12338034)

Hood Bumper  
Across the Flats: 1"  
Diameter: 15/16"  
Overall Length: 1-29/32"  
GM X Cars 1980 - On

UNIT PACKAGE: 10



**4474**  
(400764, 400765)

5/16-18 x 2-1/8"  
Hood Adjusting Bolt & Bumper  
GM

UNIT PACKAGE: 5

**4473**  
Same as 4474 except for unit package quantity

UNIT PACKAGE: 10



**16849**  
(Not Supplied by O.E.M.)  
Nylon

Hood Adjustment Nut  
Threaded Insert: M6-1.0  
Ford 1989 - On

UNIT PACKAGE: 10

**16850**  
(Not Supplied by O.E.M.)  
Zinc

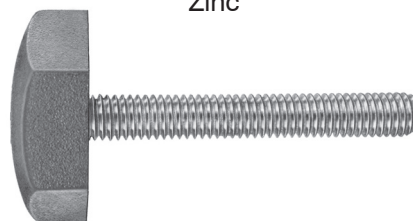

M6-1.0 x 44mm  
Hood Adjustment Bumper  
Hex: 23mm  
Ford 1989 - On

UNIT PACKAGE: 5



**16832**  
(E83Z-16758-A)

Hood Adjustment Nut & Bumper  
Ford 1989 - On

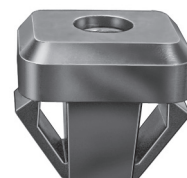

UNIT PACKAGE: 2 Sets



**Door Seals**

| Years   | Vehicle                  | Application                  | O.E.M. Number                      | Auveco Part No. |
|---------|--------------------------|------------------------------|------------------------------------|-----------------|
| 1991-73 | Blazer, Jimmy & Suburban | Driver & Passenger Rear Side | 15606409,<br>15227654,<br>15227655 | <b>20792</b>    |
| 1987-73 | Pickup                   | Driver & Passenger Side      | 15606409,<br>15227654,<br>15227655 | <b>20792</b>    |



**Window Channels**



| Years   | Vehicle                  | Application  | O.E.M. Number | Auveco Part No. |
|---------|--------------------------|--|---------------|-----------------|
| 1991-73 | Blazer, Jimmy & Suburban | Complete Glass Run with metal clip<br>Front – Driver Side  | 14027777      | <b>20793</b>    |
| 1991-73 | Blazer, Jimmy & Suburban | Complete Glass Run with metal clip<br>Front-Passenger Side | 14027778      | <b>20794</b>    |
| 1987-73 | Pickup                   | Complete Glass Run with metal clip<br>Front-Driver Side    | 14027777      | <b>20793</b>    |
| 1987-73 | Pickup                   | Complete Glass Run with metal clip<br>Front-Passenger Side | 14027778      | <b>20794</b>    |

**Belt Weatherstrips**



| Years   | Vehicle                          | Application          | O.E.M. Number | Auveco Part No. |
|---------|----------------------------------|----------------------|---------------|-----------------|
| 1991-81 | Blazer, Jimmy & Suburban         | Inner-Driver Side    | 15569071      | <b>20797</b>    |
| 1991-81 | Blazer, Jimmy & Suburban         | Inner-Passenger Side | 15569072      | <b>20798</b>    |
| 1991-73 | Blazer, Jimmy & Suburban         | Outer-Driver Side    | 14027775      | <b>20799</b>    |
| 1991-73 | Blazer, Jimmy & Suburban         | Outer-Passenger Side | 14027776      | <b>20800</b>    |
| 1987-81 | Pickup                           | Inner-Driver Side    | 15569071      | <b>20797</b>    |
| 1987-81 | Pickup                           | Inner-Passenger Side | 15569072      | <b>20798</b>    |
| 1987-73 | Pickup                           | Outer-Driver Side    | 14027775      | <b>20799</b>    |
| 1987-73 | Pickup                           | Outer-Passenger Side | 14027776      | <b>20800</b>    |
| 1980-73 | Pickup, Jimmy, Blazer & Suburban | Inner-Driver Side    | 470433        | <b>20795</b>    |
| 1980-73 | Pickup, Jimmy, Blazer & Suburban | Inner-Passenger Side | 470434        | <b>20796</b>    |



**Vent Window Seals**

| Years   | Vehicle                          | Application                                     | O.E.M. Number | Auveco Part No. |
|---------|----------------------------------|---|---------------|-----------------|
| 1980-73 | Pickup, Jimmy, Blazer & Suburban | Front Driver Side (Vertical sold separately)    | 6271903       | <b>20801</b>    |
| 1980-73 | Pickup, Jimmy, Blazer & Suburban | Front Passenger Side (Vertical sold separately) | 6271904       | <b>20803</b>    |
| 1980-73 | Pickup, Jimmy, Blazer & Suburban | Rear Vertical-Driver Side                       | 6271905       | <b>20802</b>    |
| 1980-73 | Pickup, Jimmy, Blazer & Suburban | Rear Vertical-Pass. Side                        | 6271906       | <b>20804</b>    |

# GLASS SETTING CHANNELS

EPDM Dense Rubber

Sec. 16



## 4511

For 1/8" Glass  
Glass Setting Channel  
Height: 11/32"  
Width at Base: 1/4"  
Inside Base: 1/8"

UNIT PACKAGE: 50 Ft.



## 4513

For 1/4" Glass  
Windshield and Rear Window  
Glass Setting Channel  
Height: 7/16"  
Width at Base: 31/64"  
Inside Base: 1/4"

UNIT PACKAGE: 50 Ft.



## 4512

For 3/16" Glass  
Windshield and Rear Window  
Glass Setting Channel  
Height: 7/16"  
Width at Base: 27/64"  
Inside Base: 3/16"

UNIT PACKAGE: 50 Ft.



## 4688

For 1/4" Glass  
Rear Window Glass  
Setting Channel  
Chrysler Early Models

UNIT PACKAGE: 50 Ft.



## 4670

For 1/4" Glass  
Windshield &  
Rear Window Glass Setting  
Channel and Weatherstrip  
Ford, Mercury Early Models

UNIT PACKAGE: 50 Ft.



## 4588

For 1/4" Glass  
Windshield and Rear Window  
Glass Setting Channel  
Height: 9/16"  
Width at Base: 7/16"  
Inside Base: 1/4"

UNIT PACKAGE: 50 Ft.



## 4515

For 1/4" Glass  
Glass Setting Channel  
Height: 9/16"  
Width at Base: 25/64"  
Inside Base: 1/4"

UNIT PACKAGE: 50 Ft.



## 4671

For 1/4" Glass  
Rear Window Glass  
Setting Channel and  
Weatherstrip  
Chrysler Early Models

UNIT PACKAGE: 50 Ft.

## Molded Dense Rubber Tee Rubber Concave Head

UNIT PACKAGE: 50 Ft.



## 4530

Head: 9/32"  
Height: 3/4"

## 4531

Head: 9/32"  
Height: 1"



## 4581

For 1/4" glass  
Windshield Glass Weatherstrip

UNIT PACKAGE: 50 Ft.

## Universal Windshield & Rear Window Flex-Fit Rubber Moulding



Photo not actual size

## 20342

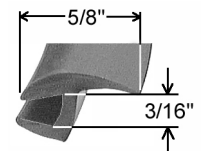

A universal windshield rubber moulding for domestic and import vehicles. Made of EPDM rubber, this moulding contains a butyl bead that adheres to the glass during installation. The profile design allows for the moulding to attach easily to the glass edge and lay evenly on the vehicle body along straight areas and around corners. Extruded with a metal filament to prevent stretching and shrinkage.

UNIT PACKAGE: 15 Feet

# Sec. 16

# EPDM RUBBER WEATHERSTRIP FOR GLASS

Photos not actual size



## 17509

Glass Thickness: 1/4"  
Body Thickness: 1/16"  
Self-Locking Type

UNIT PACKAGE: 50 Ft.



## 17513

Glass Thickness: 1/4"  
Body Thickness: 1/8"  
Bead Lock Type  
Use with  
Auveco 17514

UNIT PACKAGE: 50 Ft.



## 17510

Glass Thickness: 1/4"  
Body Thickness: 1/8"  
Self-Locking Type

UNIT PACKAGE: 50 Ft.



## 17514

Glass Thickness 1/4"  
Locking Bead  
Use with Auveco 17513

UNIT PACKAGE: 50 Ft.

## Caps & Hooks

### Rubber Caps

Special Heat Resistant EPDM Rubber  
Can be used for capping lines and hoses while testing carburetors, emission control systems, vacuum lines, etc



| Auveco Part No. | Fits Tube O.D. | Inside Length | Unit Pkg. |
|-----------------|----------------|---------------|-----------|
| 12209           | 1/8"           | 9/16"         | 25        |
| 4440            | 3/16"          | 9/16"         | 25        |
| 16264           | 3/16"          | 9/16"         | 100       |
| 19000           | 3/16"          | 1-1/4"        | 25        |
| 4439            | 1/4"           | 9/16"         | 25        |
| 19001           | 1/4"           | 1-1/4"        | 25        |
| 19002           | 5/16"          | 9/16"         | 25        |
| 12907           | 5/16"          | 1-1/4"        | 25        |
| 12210           | 3/8"           | 31/32"        | 25        |
| 19003           | 3/8"           | 1-1/2"        | 25        |
| 12908           | 1/2"           | 11/16"        | 10        |

### Vinyl Vacuum Caps

Can be used for capping lines and hoses while testing carburetors, emission control systems, vacuum lines, etc. Color coded for size identification.



| Auveco Part No. | I.D.  | Fits Tube O.D. | Color | Length | Unit Pkg. |
|-----------------|-------|----------------|-------|--------|-----------|
| 18202           | 1/8"  | 3/16"          | Blue  | 5/8"   | 50        |
| 18203           | 3/16" | 1/4"           | Red   | 5/8"   | 50        |
| 18204           | 1/4"  | 5/16"          | White | 5/8"   | 50        |
| 18205           | 5/16" | 3/8"           | Black | 5/8"   | 50        |

### Rubber Hold Down Straps with Hooks

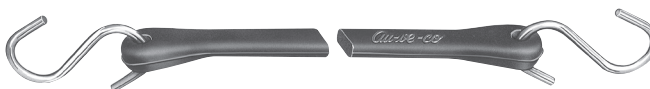

| Auveco Part No. | Length | Span Range | Unit Pkg. |
|-----------------|--------|------------|-----------|
| 4448            | 9"     | 15" to 20" | 10        |
| 4449            | 15"    | 20" to 30" | 10        |
| 4450            | 20"    | 30" to 40" | 10        |
| 4451            | 31"    | 40" to 55" | 10        |

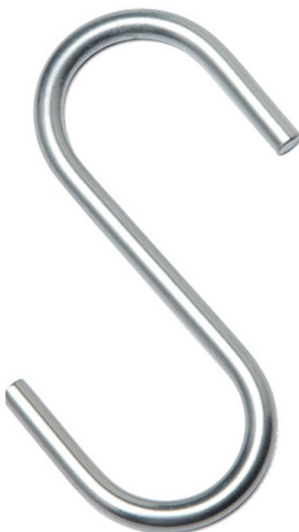

## 11298

Galvanized

3/16" x 3"  
"S" Hook

Used with Auveco Rubber Hold Down Straps 4448, 4449, 4450 and 4451

UNIT PACKAGE: 50

## 11299

Same as 11298 except for unit package quantity

UNIT PACKAGE: 100



**18979**  
(3767196)

Windshield Setting Block  
Lower Spacer  
Chrysler Caravan,  
Voyager and Town & Country  
1984 - On

UNIT PACKAGE: 15

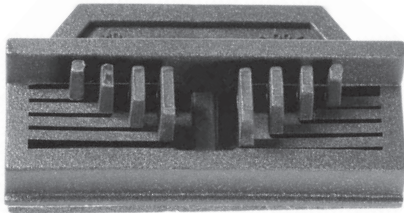

**21195**  
(15061964)  
Black Nylon

Windshield Glass  
Setting Block with  
Adhesive Backing

Overall Length: 51mm  
Buick Rainier; Cadillac Escalade; Chevrolet  
Avalanche, Colorado, Silverado, Suburban, Tahoe  
& Trailblazer; GMC Canyon, Envoy, Sierra & Yukon;  
Hummer H2 & H3 Oldsmobile Bravada and Saab 9-7  
1999 - On

UNIT PACKAGE: 10



**20836**  
(4L3Z-1503296-AB)  
Black Nylon

Windshield Setting Block  
Ford Pick-Up Trucks  
2004 - On

UNIT PACKAGE: 5

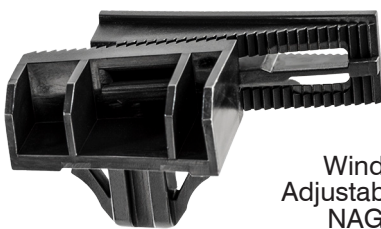

**19816**  
(55256967AC)  
Black & Natural  
Nylon

Windshield Glass  
Adjustable Setting Block  
NAGS Numbers:  
DW0999 & DW1295  
Dodge Dakota & Durango 1997 - On

UNIT PACKAGE: 10



**20942**  
(F6DZ-5403296-A)  
Black Nylon

Windshield Setting Block  
Width: 1-5/32"  
Length: 1-1/8"  
Height: 13/16"  
Fits into 9/32" Square Hole  
Ford Sable & Taurus 1996 - On

UNIT PACKAGE: 10



**19817**  
Black Nylon

Universal Glass Setting Block  
Width: 1-3/16"  
Height: 7/16"  
Length: 15/16"

UNIT PACKAGE: 25



**3135**

Window Regulator  
Roller Assembly  
Ford

UNIT PACKAGE: 25



**10843**  
(3696693)  
Nylon

Front Door Glass Lift to Stabilizer Bushing  
Chrysler

UNIT PACKAGE: 50



**21423**  
(BMW: 51321-938-884)  
White Nylon

Window Regulator Guide  
BMW 3 & 5 Series 1989 - On

UNIT PACKAGE: 2



**2598**  
(353745-S)

Window Regulator Arm to Plate  
Assembly Clip  
Ford

UNIT PACKAGE: 100



**1267**  
Lacquered

Inside Door Handle &  
Quarter Regulator  
Handle Escutcheon  
Tension Spring

UNIT PACKAGE: 25



**2288**  
Zinc

Door & Window Crank Handle  
Retaining Clip  
GM, Ford & Toyota

UNIT PACKAGE: 100





**9886**

Door & Window Crank Handle Retaining Clip

UNIT PACKAGE: 100



**11**

Coppered Spring Steel

Door & Window Crank Handle Retaining Clip  
GM

UNIT PACKAGE: 100



**16340**

(54229-0201P)

Window Crank Handle Retaining Clip  
Nissan

UNIT PACKAGE: 100



**11152**

(GM: 9731301; AMC: 4005540)  
White Nylon

Windshield to Panel (Lower) Side Moulding Clip  
GM 1975 - On  
AMC 1975 - On

UNIT PACKAGE: 100



**15813**

(4005714)  
Nylon

Window Glass Retainer  
AMC Eagle 1988 - On

UNIT PACKAGE: 25



**9633**

(7698976)

Windshield Upper & Lower Moulding Clip  
GM 1967 - On

UNIT PACKAGE: 100

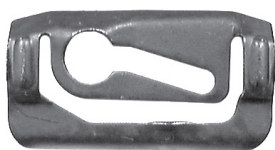

**9749**

(7730788)

Windshield, Skylight, Quarter & Rear Window Reveal Moulding Clip  
GM 1968 - On

UNIT PACKAGE: 50



**8583**

(4533699)

Rear Window Reveal Moulding Clip  
GM 1965 - On

UNIT PACKAGE: 100

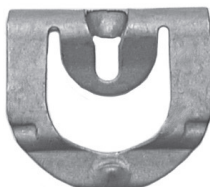

**9275**

(7634583, 8734067)

Rear Window Reveal Moulding Clip  
GM 1966 - On

UNIT PACKAGE: 50

**10242**

Same as 9275 except for unit package quantity

UNIT PACKAGE: 100



**9639**

(7693140)

Windshield, Skylight, Rear & Quarter Window Reveal Moulding Clip  
GM 1966 - On

UNIT PACKAGE: 50



**11066**

(9624520)

Window Reveal Moulding Clip  
GM 1973 - On

UNIT PACKAGE: 50



**11067**

(9606232, 9662950, 20603072)

Windshield & Rear Window Reveal Moulding Clip  
GM 1973 - On

UNIT PACKAGE: 100



**10243**

(8717859)

Rear Window Reveal Moulding Clip  
GM 1969 - On

UNIT PACKAGE: 100

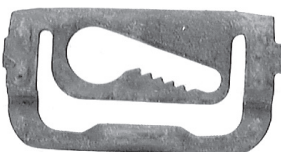

**10701**

(9895598)

Windshield Reveal Moulding Clip  
GM 1971 - On

UNIT PACKAGE: 50



**10630**  
(9808241)

Windshield & Rear Window Reveal  
Moulding Clip  
GM 1970 - On

UNIT PACKAGE: 50



**10631**  
(9854717)

Windshield Reveal Moulding Clip  
GM 1970 - On

UNIT PACKAGE: 50



**11345**  
(1654047)  
Nylon

Windshield & Rear Window Reveal  
Moulding Clip  
GM 1974 - On

UNIT PACKAGE: 100



**12135**  
(20169887)  
Nylon

Windshield Reveal Moulding Clip  
GM 1979 - On

UNIT PACKAGE: 50



**11152**  
(GM: 9731301; AMC: 4005540)  
White Nylon

Windshield to Panel (Lower)  
Side Moulding Clip  
GM 1975 - On  
AMC 1975 - On

UNIT PACKAGE: 100

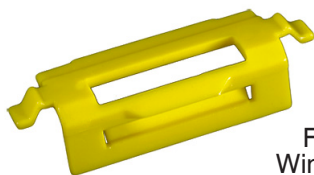

**20232**  
(10287926)  
Yellow Nylon

Front & Rear Door  
Window Moulding Clip  
Overall Length: 1-9/16"  
Buick Century & Regal  
and Oldsmobile Intrigue 1997 - On

UNIT PACKAGE: 25

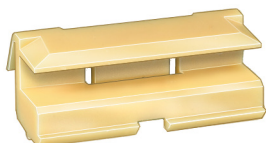

**17355**  
(GM: 94467458;  
Isuzu: 8944674584)  
Nylon

Windshield Reveal Moulding Clip  
Geo Storm 1992 - On

UNIT PACKAGE: 10



**20263**  
(22599312)  
Black Nylon

Front & Rear Door  
Window Moulding Clip  
Chevrolet Malibu, Oldsmobile  
Achieva & Cutlass 1997 - On

UNIT PACKAGE: 25



**2628**  
(4657731)

Windshield & Rear Window  
Reveal Moulding Fastener  
GM

UNIT PACKAGE: 100



**20276**

(6003409, 6003752)

Windshield & Rear Window  
Reveal Moulding Clip  
**Replaces Auveco 11177 & 13569**  
Chrysler 1974 - On

UNIT PACKAGE: 25



**10622**  
(6002893)

Rear Window Reveal Moulding Clip  
Chrysler 1971 - On

UNIT PACKAGE: 50



**17151**  
(6004036)  
Nylon

Window Reveal Moulding Clip  
Chrysler LeBaron & Maserati  
1987 - On

UNIT PACKAGE: 15



**9882**

(C8AZ-63642413-A,  
D1AZ-6542413-B,  
D1AB-6542413-AB)

Windshield & Rear Window  
Reveal Moulding Clip  
Ford 1968 - On

UNIT PACKAGE: 100



**9353**

(C6AB-6242413-A)

Rear Window  
Reveal Moulding Clip  
Ford 1967 - On

UNIT PACKAGE: 100



**8941**  
(C5ZZ-6543413-B)

Windshield & Rear Window  
Reveal Moulding Clip  
Ford 1966 - On

UNIT PACKAGE: 100



**13564**  
(E3SB-6342413-AB)

Windshield & Bakelite  
Reveal Moulding Clip  
Ford 1983 - On

UNIT PACKAGE: 50



**21526**  
(Not Available from O.E.M.)  
White Nylon

Windshield Moulding Clip  
Head Size: 14.5mm x 30mm  
Bottom Leg Width: 26mm  
Ford Flex 2009 - On

UNIT PACKAGE: 25



**20424**  
(Not Available from O.E.M.)  
White Nylon

Front Door Window Guide  
Overall Length: 1-13/32"  
Buick Electra, Park Ave. & Skylark; Chevrolet Malibu;  
Oldsmobile Achieva, Alero, Cutlass & 98 Regency  
and Pontiac Grand Am 1985 - On

UNIT PACKAGE: 5



**21022**  
(4339372)  
Black Nylon

Window Guide  
with Rivets  
Chrysler Acclaim,  
GTS, Lancer, LeBaron,  
Shadow, Spirit &  
Sundance 1989 - On

UNIT PACKAGE: 25



**15462**  
(20478733,  
22539533)  
Nylon

Front Door Window  
Guide Rear of Glass  
Buick Skylark & Somerset 1991 - 85  
Chevrolet Lumina APV 1990 - On  
Olds Calais 1991 - 85  
Olds Silhouette 1990 - On  
Pontiac Grand Am 1991 - 85  
Pontiac Trans Sport 1990 - On

UNIT PACKAGE: 15

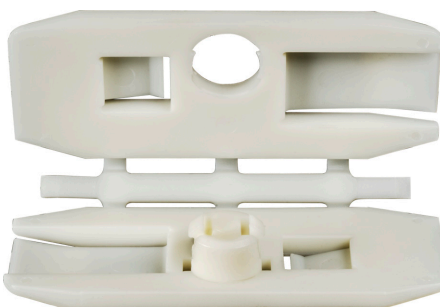

**19397**  
(21098967)  
Nylon

Front &  
Rear Door  
Window Guide  
Saturn Sedan &  
Wagon  
1996 - On

UNIT PACKAGE: 5



**15463**  
(12353912, 20487630, 20712176)  
Nylon

Front Door Window Guide  
Front of Glass (4mm Thick)  
Buick Skylark & Somerset 1991-85  
Chevrolet Lumina APV 1990-On; Olds Calais 1991-85;  
Olds Silhouette 1990-On; Pontiac Grand Am 1991-85  
Pontiac Trans Sport 1990-On

UNIT PACKAGE: 15



**15466**  
(20160591)  
Nylon

Front Door  
Window Guide  
Upper Part of Glass  
LeSabre 90-80 &  
Electra 84-On; Fleetwood Brougham & DeVille 83-On;  
Impala & Caprice 90-80 & Cavalier 87; Delta 88 &  
Custom Cruiser 90-80 & 98 Regency 84-80;  
Parisienne & Safari 89-81 & Sunbird 87

UNIT PACKAGE: 25



**15467**

(10051034, 20123070,  
20328600)  
Nylon

Front & Rear Door  
Window Guide  
Electra, Estate  
Wagon, LeSabre &  
Skylark; DeVille;  
Impala Wagon, Caprice &  
Citation; Delta 88, Custom Cruiser, 98 Regency &  
Omega; Catalina, Safari & Phoenix 81 - 80

UNIT PACKAGE: 25

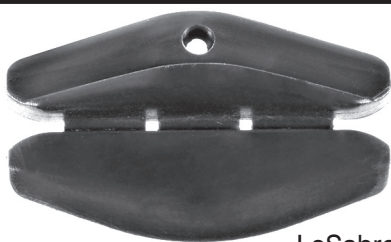

**17159**

(20747509)  
Nylon

Front Door Window  
Guide Rear of Glass  
Buick Electra &  
LeSabre Cadillac Fleetwood/  
DeVile Olds Delta & Regency Pontiac Bonneville  
1985 - On

UNIT PACKAGE: 15

*Photo not actual size*

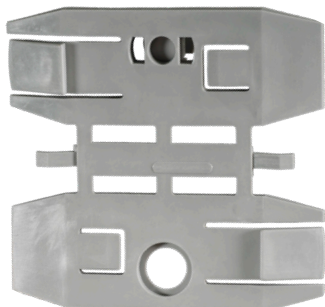

**19819**

(10274778)  
Nylon

Front Side Door  
Window Guide  
Chevrolet Venture APV,  
Oldsmobile Silhouette APV,  
Pontiac Montana &  
Trans Sport APV  
1997 - On

UNIT PACKAGE: 10



**17176**

(20162174, 22543363)  
Nylon

Front Door  
Window Guide  
Buick Skyhawk,  
Cadillac Cimarron,  
Chevrolet Cavalier, Olds Firenza  
& Pontiac Sunbird 1982-On

UNIT PACKAGE: 25



**17341**

(12337898, 20747508)  
Nylon

Front Door Window  
Guide Front of Glass  
Buick Electra, LeSabre &  
Park Ave., Cadillac Fleetwood  
& DeVille, Olds 88 Royal & 98  
Regency, Pontiac Bonneville 1985-On

*Photo not  
actual size*

UNIT PACKAGE: 15



**17455**

(20493450)  
Nylon

Rear Door Window  
Guide Upper Glass  
Chevrolet Corsica  
1987 - On

UNIT PACKAGE: 15



**18113**

(69951-12180)

Nylon with Steel Treaded Insert

Glass Mount  
Thread: M6-1.0  
Nissan, Ford & Imports

UNIT PACKAGE: 5



**19393**

(F1TZ-17698A)

Rear View Mirror Bracket  
(Windshield Mounted)  
NAGS numbers DW 1256,  
1099 1169 & 1170

Fits Ford Mirrors F0TZ-17700-A & F7AZ-17700-A on  
Ford & L-M Continental, Contour, Escort, Mustang,  
Mystique, Sable, Taurus & Tracer 1991 - On

UNIT PACKAGE: 10



**19394**

(20626174)

Rear View Mirror Bracket  
(Windshield Mounted)  
NAGS numbers 1168, 1191,  
1192, 1193, 1194, 1195,  
1265, 1288 & 1299  
GM 1987-On

UNIT PACKAGE: 10



**19498**

Black Nylon

Rear View Mirror  
Adapter Bracket

This adapter bracket allows you to reuse the original  
mirror when a windshield is replaced. If the new  
windshield comes with a steel mirror button attached,  
this adapter fits over the button. Then the original  
mirror can be fitted onto the bracket.

GM & Chrysler 1981 - On

UNIT PACKAGE: 3

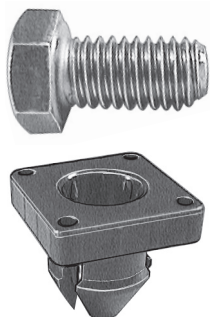

**19281**  
(F5RZ-5421416B)

Door Window Glass to  
Regulator Fastener Assembly  
3/8"-16 x 3/4"  
Grade 8 Cap Screw  
Ford Contour & Mystique  
1995 - On

UNIT PACKAGE: 2 Sets

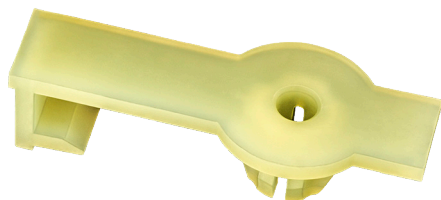

**20309**  
(5008055AA)  
Natural Nylon

Window to  
Regulator  
Grommet

Screw Size: #14 (M6.3)  
Overall Length: 57mm  
Stem Length: 10mm  
Fits into 13mm Hole  
Dodge Neon 2000 - On

UNIT PACKAGE: 15

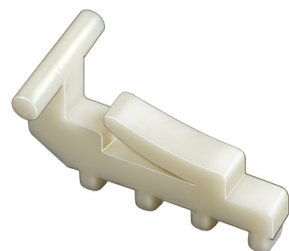

**17073**  
(20085729)  
Nylon

Window Regulator Drive Block  
used with Window  
Regulator Tape  
GM 1980 - On

UNIT PACKAGE: 25

**16959**

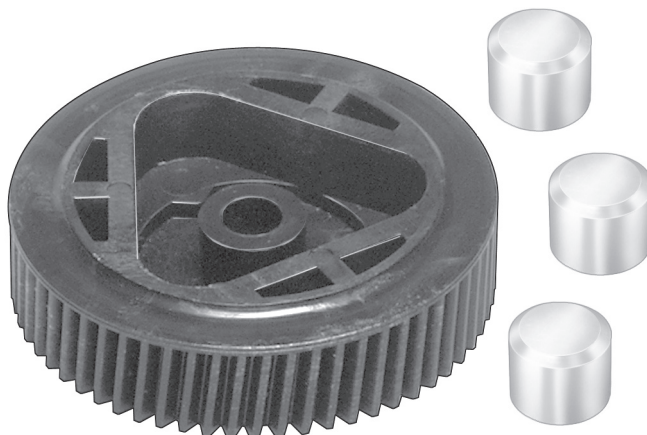

*Photo not actual size*

Piano Wire  
For Cutting through Sealant on  
Windshields without Gaskets  
Solid not Braided Wire  
1/4 Pound (approx. 160 Ft.)  
Wire Diameter: .025"

UNIT PACKAGE: 1 Roll

**18947**



Power Window Regulator Gear & Rollers  
Splines: 62  
Ford 1989 - On

UNIT PACKAGE: 1



**19786**

(Not Available from O.E.M.)  
Natural Nylon

Torque Pin Kit for  
Window Regulator Gear  
Pin Diameter: 1/2"  
Pin Length: 13/32"  
Ford 1964 - On

UNIT PACKAGE: 15

**17974**

(D0AZ-62234A24)



Power Window  
Regulator Gear  
Tooth: 9  
Splines: 45  
Ford 1964 - On

UNIT PACKAGE: 1

*Photos not actual size*

## O.E.M. Replacement Horns

**19017**



Domestic Vehicles - Low Note  
Terminals: One/Two  
Frequency (Hz): 400  
Decibel Rating at 4": 125  
Current Draw (Amps): 6  
Power Source Volts: 12

UNIT PACKAGE: 1

**19019**



Import Vehicles - Low Note  
Terminals: One/Two  
Frequency (Hz): 340  
Decibel Rating at 4": 130  
Current Draw (Amps): 5  
Power Source Volts: 12

UNIT PACKAGE: 1

**19018**



Domestic Vehicles - High Note  
Terminals: One/Two  
Frequency (Hz): 500  
Decibel Rating at 4": 125  
Current Draw (Amps): 6  
Power Source Volts: 12

UNIT PACKAGE: 1

**19020**



Import Vehicles - High Note  
Terminals: One/Two  
Frequency (Hz): 425  
Decibel Rating at 4": 130  
Current Draw (Amps): 5  
Power Source Volts: 12

UNIT PACKAGE: 1

## Freeway Blaster Horns ("Big Rig" Sound)

**19021**



Low Note  
Terminals: One/Two  
Frequency (Hz): 400  
Decibel Rating at 4": 130  
Current Draw (Amps): 6  
Power Source Volts: 12

UNIT PACKAGE: 1

**19022**



High Note  
Terminals: One/Two  
Frequency (Hz): 500  
Decibel Rating at 4": 130  
Current Draw (Amps): 6  
Power Source Volts: 12

UNIT PACKAGE: 1

**Riviera Air Horns & Compressor Kit**

**19023**

*Photo not actual size*



The Riviera air-powered dual horns sound simultaneously and have the "European" sound. Comes complete with a 12 volt compressor, relay, tubing and mounting hardware.

UNIT PACKAGE: 1 Set

**19024**

*Photo not actual size*

Horn Relay  
12 Volt

UNIT PACKAGE: 1

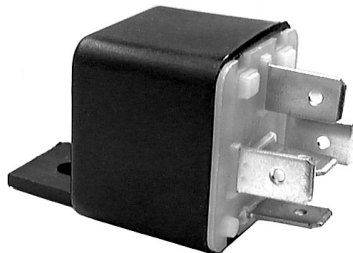

**Horn Application Guide**

| Year  | Make & Model   | Original Equipment Replacement | Freeway Blaster (Optional) |
|---|--|--------------------------------|----------------------------|
| <b>ACURA</b>                                  |  |                                |                            |
| 12-90   | All Models   | *19022 & 19021                 |                            |
| <b>AMC</b>                                    |  |                                |                            |
| 90-79   | Alliance, Encore, Talon  | 19019 & 19020                  | 19022 & 19021              |
| 90-74   | All Other Models   | 19018 & 19017                  | 19022 & 19021              |
| <b>AUDI</b>                                   |  |                                |                            |
| 12-73   | All Models   | *19018                         | *19022                     |
| <b>BMW</b>                                    |  |                                |                            |
| 12-95   | 5, 7, & 9 Models   | 19018 & 19017                  | 19022 & 19021              |
| 12-74   | All Other Models   | 19019 & 19020                  | 19022 & 19021              |
| <b>BUICK</b>                                  |  |                                |                            |
| 12-86   | All Other Models   | 19022 & 19021                  |                            |
| 96-75   | Skyhawk & Skylark  | *19018                         | *19022                     |
| <b>CADILLAC</b>                               |  |                                |                            |
| 12-75   | All Other Models   | 19022 & 19021                  |                            |
| 83-81   | Cimarron   | *19018                         | *19022                     |
| <b>CHEVROLET</b>                              |  |                                |                            |
| 12-76   | Aveo, Beretta, Cavalier, Celebrity, Chevette, Citation, Corsica, Spectrum, Sprint & Nova | *19018                         | *19022                     |
| 12-71   | Corvette   | 19022 & 19021                  |                            |
| 12-71   | All Other Models   | 19018 & 19017                  | 19022 & 19021              |
| <b>CHEVROLET LIGHT DUTY TRUCKS &amp; VANS</b> |  |                                |                            |
| 12-75   | S-10   | 19018 & 19017                  | 19022 & 19021              |
| 12-75   | All Other Models   | 19022 & 19021                  |                            |
| <b>CHRYSLER</b>                               |  |                                |                            |
| 12-77   | All Other Models   | 19018 & 19017                  | 19022 & 19021              |
| 10-95   | Sebring  | 19019 & 19020                  | 19022 & 19021              |
| 97-87   | LeBaron & GTS  | 19018                          | *19021                     |
| <b>DODGE</b>                                  |  |                                |                            |
| 12-74   | All Other Models   | 19018 & 19017                  | 19022 & 19021              |
| 05-95   | Neon   | *19020                         | *19022                     |

| Year                                      | Make & Model   | Original Equipment Replacement | Freeway Blaster (Optional) |
|---|--|--------------------------------|----------------------------|
| <b>DODGE</b>                              |  |                                |                            |
| 99-87                                     | Charger, Lancer, Omni, Shadow, Spirit  | *19018                         | *19022                     |
| 98-74                                     | Challenger, Colt   | *19020                         | *19022                     |
| <b>DODGE LIGHT DUTY TRUCKS &amp; VANS</b> |  |                                |                            |
| 12-87                                     | Dakota, Ram, Pickup, Caravan   | *19021                         |                            |
| 12-75                                     | All Other Models   | 19022 & 19021                  |                            |
| <b>FORD</b>                               |  |                                |                            |
| 12-07                                     | Edge   | 19018 & 19017                  | 19022 & 19021              |
| 12-01                                     | Escape   | 19018 & 19017                  | 19022 & 19021              |
| 12-71                                     | Escort, Fairmont, Festiva, Focus, Maverick Mustang II, Pinto, Tempo, Contour | *19018                         | *19022                     |
| 12-70                                     | All Other Models   | 19022 & 19021                  |                            |
| 97-77                                     | Fiesta   | 19020                          | 19022                      |
| <b>FORD LIGHT DUTY TRUCKS &amp; VANS</b>  |  |                                |                            |
| 12-85                                     | All Other Models   | 19022 & 19021                  |                            |
| 90-75                                     | Ranger, E 150/350 Vans, Aerostar, Economize                                  | *19022                         |                            |
| <b>GEO</b>                                |  |                                |                            |
| 12-90                                     | All Other Models   | *19019                         | *19021                     |
| 99-90                                     | Storm  | 19019 & 19020                  | 19022 & 19021              |
| <b>GMC LIGHT DUTY TRUCKS &amp; VANS</b>   |  |                                |                            |
| 12-75                                     | All Other Models   | 19018 & 19017                  | 19022 & 19021              |
| 92-91                                     | Jimmy, Sonoma  | *19021                         |                            |
| <b>HONDA</b>                              |  |                                |                            |
| 12-80                                     | Civic, Civic Del Sol   | *19020                         | *19022                     |
| 12-73                                     | All Other Models   | 19019 & 19020                  | 19022 & 19021              |
| <b>HYUNDAI</b>                            |  |                                |                            |
| 12-86                                     | All Other Models   | 19019 & 19020                  | 19022 & 19021              |
| 87-84                                     | Pony   | 19020                          | 19022                      |

| Year                   | Make & Model  | Original Equipment Replacement | Freeway Blaster (Optional) |
|------------------------|---|--------------------------------|----------------------------|
| <b>INFINITI</b>        |   |                                |                            |
| 12-90                  | All Models  | 19022 & 19021                  |                            |
| <b>ISUZU</b>           |   |                                |                            |
| 12-83                  | Impulse, Stylus, Trooper  | 19019 & 19020                  | 19022 & 19021              |
| 12-81                  | I Mark, Amigo, Pickup, Rodeo                                    | *19020                         | *19022                     |
| <b>JAGUAR</b>          |   |                                |                            |
| 12-72                  | All Models  | 19022                          | 19021                      |
| <b>JEEP</b>            |   |                                |                            |
| 12-74                  | Cherokee, Grand Cherokee  | 19022 & 19021                  |                            |
| 12-70                  | CJ, DJ, Scrambler, Wrangler                                     | *19018                         | *19022                     |
| <b>LEXUS</b>           |   |                                |                            |
| 12-90                  | All Models  | 19022 & 19021                  |                            |
| <b>LINCOLN-MERCURY</b> |   |                                |                            |
| 12-74                  | All Other Models  | 19022 & 19021                  |                            |
| 99-71                  | Capri & Capri II  | *19020                         | *19022                     |
| 99-71                  | Bobcat, Lynx, Zephyr, Tracer, Mystique, Topaz                   | *19018                         | *19022                     |
| <b>MAZDA</b>           |   |                                |                            |
| 12-91                  | Navajo  | 19018 & 19017                  | 19022 & 19021              |
| 12-75                  | All Other Models  | 19019 & 19020                  | 19022 & 19021              |
| 12-71                  | RX-2, RX-3, Mizer, MX-3, MX-5, Protege, GLC Wagon, B2200, B2601 | *19020                         | *19022                     |
| <b>MAZDA TRUCK</b>     |   |                                |                            |
| 12-78                  | All Models  | *19019                         | *19021                     |
| <b>MERCEDES</b>        |   |                                |                            |
| 12-73                  | All Models  | 19022 & 19021                  |                            |
| <b>MITSUBISHI</b>      |   |                                |                            |
| 12-83                  | All Models  | 19019 & 19020                  | 19022 & 19021              |
| <b>NISSAN</b>          |   |                                |                            |
| 12-97                  | All Models  | 19018 & 19017                  | 19022 & 19021              |
| 96-74                  | All Other Models  | 19019 & 19020                  | 19022 & 19021              |
| 90-87                  | Pulsar  | *19020                         | 19022                      |
| <b>NISSAN TRUCK</b>    |   |                                |                            |
| 12-93                  | Quest   | 19018 & 19017                  | 19022 & 19021              |
| 12-82                  | All Other Models  | 19019                          | *19021                     |
| <b>OLDSMOBILE</b>      |   |                                |                            |
| 04-91                  | Bravada   | *19017                         | *19021                     |
| 04-98                  | Alero   | 19018 & 19017                  | 19022 & 19021              |
| 04-74                  | All Other Models  | 19022 & 19021                  | *19021                     |
| 89-88                  | Firenza   | 19018                          | 19022                      |
| <b>PLYMOUTH</b>        |   |                                |                            |
| 01-75                  | All Other Models  | *19018                         | *19022                     |
| 89-71                  | Arrow, Champ, Colt, Laser                                       | *19020                         | *19022                     |

| Year                              | Make & Model  | Original Equipment Replacement | Freeway Blaster (Optional) |
|-----------------------------------|---|--------------------------------|----------------------------|
| <b>PLYMOUTH TRUCKS &amp; VANS</b> |   |                                |                            |
| 01-74                             | All Models  | *19017                         | *19021                     |
| <b>PONTIAC</b>                    |   |                                |                            |
| 10-95                             | Trans Sport Montana                                   | 19018 & 19017                  | 19022 & 19021              |
| 10-75                             | All Other Models                                      | 19018 & 19017                  | 19022 & 19021              |
| 94-93                             | Trans Sport   | *19017                         | *19021                     |
| 94-82                             | Astre, J-2000, T-1000, LeMans, Sunbird                | 19019                          | *19021                     |
| 87-84                             | Fiero   | 19019 & 19020                  | 19022 & 19021              |
| <b>PORSCHE</b>                    |   |                                |                            |
| 12-70                             | All Models  | 19018 & 19017                  | 19022 & 19021              |
| <b>RANGE ROVER</b>                |   |                                |                            |
| 12-01                             | All Models  | 19022 & 19021                  |                            |
| <b>SAAB</b>                       |   |                                |                            |
| 12-79                             | All Models  | 19019 & 19020                  | 19022 & 19021              |
| <b>SATURN</b>                     |   |                                |                            |
| 10-07                             | Outlook   | 19018 & 19017                  | 19022 & 19021              |
| 10-90                             | All Other Models                                      | *19019                         | *19021                     |
| <b>SUBARU</b>                     |   |                                |                            |
| 12-78                             | All Other Models                                      | 19019 & 19020                  | 19022 & 19021              |
| 94-87                             | Justy, Samurai  | *19019                         | *19021                     |
| <b>SUZUKI SUV</b>                 |   |                                |                            |
| 12-88                             | All Models  | *19019                         | *19021                     |
| <b>TOYOTA</b>                     |   |                                |                            |
| 12-91                             | Avalon, Camry   | 19018 & 19017                  | 19022 & 19021              |
| 12-80                             | Starlet, Tercel Sedan, Corolla Coupe, Sedan, Liftback | *19021                         | *19022                     |
| 12-72                             | All Other Models                                      | 19018 & 19017                  | 19022 & 19021              |
| <b>TOYOTA TRUCK</b>               |   |                                |                            |
| 12-81                             | Land Cruiser & Other Models                           | 19022 & 19021                  |                            |
| 12-70                             | 4-Runner, Pickup, Van, Paseo                          | *19020                         | *19022                     |
| 80-69                             | Land Cruiser  | *19020                         | *19022                     |
| <b>VOLKSWAGEN</b>                 |   |                                |                            |
| 12-80                             | Jetta, Quantum, Fox, Golf, Passat                     | 19019 & 19020                  | 19022 & 19021              |
| 12-74                             | All Other Models                                      | *19019                         | *19021                     |
| <b>VOLVO</b>                      |   |                                |                            |
| 12-70                             | All Other Models                                      | 19019 & 19020                  | 19022 & 19021              |
| 97-84                             | 240-740-760 Series                                    | *19020                         | *19022                     |

\*One horn is standard; however, vehicle may be equipped with optional second horn for better sound. Add another horn of opposite note (high or low).





**1720**

Door and Quarter Trim  
Panel Fastener  
Chrysler

UNIT PACKAGE: 100



**2385**

Door Trim  
Panel Fastener  
Chrysler

UNIT PACKAGE: 100



**2309**

Door Trim Panel Fastener  
All cars with .125 Panels  
Ford

UNIT PACKAGE: 100



**808**

General Purpose  
Head Diameter: 1/2"  
Chrysler

UNIT PACKAGE: 100



**8206**

Door Trim  
Panel Fastener  
Ford

UNIT PACKAGE: 100



**2310**

Door Trim  
Panel Fastener  
Chrysler

UNIT PACKAGE: 100



**11863**

(383033-S101)  
Phosphate

Door Trim  
Panel Fastener  
Ford

UNIT PACKAGE: 50

**10780**

Same as 11863 except for unit packaging quantity

UNIT PACKAGE: 100



**807**

General Purpose  
Head Diameter: 1/2"  
Chrysler

UNIT PACKAGE: 100



**9361**

(Ford: 358470; Chry: 1900654)

Door Trim Panel Fastener  
Ford & Chrysler

UNIT PACKAGE: 100



**2272**

(358107)

Body Belt Moulding &  
Hood Side Moulding Fastener  
Ford

UNIT PACKAGE: 100



**1256**

(353123)

Rear Quarter Strip (Inside),  
Instrument Panel Moulding & Hood  
Side Moulding Fastener  
Ford & Chrysler

UNIT PACKAGE: 50



**11406**

Trim Clip Fastener  
Head Diameter: 1/2"  
Fits into 1/4" Hole

UNIT PACKAGE: 100



**18402**

Phosphate & Green

Weatherstrip Clip  
GM

UNIT PACKAGE: 25



**18395**

Black Phosphate

Weatherstrip Clip  
GM

UNIT PACKAGE: 50



**12134**  
(4114785)  
Zinc

Trim Panel Fastener  
Fits into 5/16" Hole  
Chrysler

UNIT PACKAGE: 50

**Bulk Quantities**

The items listed below are available in bulk quantities of 25,000 or more. Quotation on Request

- A = Head O.D.
- B = Prong Length
- C = Hole Size
- D = Width of Diamond



**5961**  
Brown

General Purpose

- A: 17/32"
- B: 7/8"
- C: 9/32"
- D: 1/2"

UNIT PACKAGE: 100



**1202**  
Sandstone

General Purpose

- A: 17/32"
- B: 1-17/64"
- C: 9/32"
- D: 7/16"

UNIT PACKAGE: 100



**V-875**  
Fender Welt

1-3/8 inch (3/16" Bead)  
Bright Smooth Vinyl Bead

UNIT PACKAGE: 50 Feet

**Footman Loops**



| Auveco Part No. | Size | Hole Size | Hole to Hole Ctr. | Overall Length | Unit Pkg. |
|-----------------|------|-----------|-------------------|----------------|-----------|
|-----------------|------|-----------|-------------------|----------------|-----------|

**Steel-Nickel Plated**

|       |                  |       |        |          |    |
|-------|------------------|-------|--------|----------|----|
| 7771  | For 1" Strap     | 7/32" | 2-1/8" | 2-5/8"   | 25 |
| 7772  | For 1-1/4" Strap | 1/4"  | 2-1/4" | 2-3/4"   | 25 |
| 7773  | For 1-1/2" Strap | 1/4"  | 2-5/8" | 3-1/8"   | 25 |
| 19401 | For 2" Strap     | 1/4"  | 3-1/8" | 3-21/32" | 25 |

**Steel • Black E • Coat Plated (168 Hrs. Salt Spray)**

|       |                  |      |        |        |    |
|-------|------------------|------|--------|--------|----|
| 19404 | For 1-1/2" Strap | 1/4" | 2-5/8" | 3-1/8" | 25 |
|-------|------------------|------|--------|--------|----|

**Hog Rings**

To attach seat covers to cushions and seat bottoms, as well as, cushion spring clips.



**7595**  
Medium

.080" Wire Diameter

UNIT PACKAGE: 500



**7644**  
Large

.088" Wire Diameter

UNIT PACKAGE: 500



**12671**

3/4" Nail (.750)  
"Nail On" Door Panel Repair Clip  
Slips on Door Panel Fastener Strip for repairs to replace broken Nails in Panel Edging  
**Replaces Auveco No. 7585**  
GM

UNIT PACKAGE: 50



**12069**  
(416629)  
Zinc

Upholstery Clips  
GM 1979-On

UNIT PACKAGE: 50



**9417**

Snap-On Trim Clip  
Panel Range: .105"-.115"

UNIT PACKAGE: 100



**9416**

Snap-On Trim Clip  
Panel Range: .060"-.090"

UNIT PACKAGE: 100



**7578**

Seat Cushion Upholstery Clip  
Can be used to repair drooping headliners in Honda.

UNIT PACKAGE: 500



**7707**

Cloth Lined Cushion Spring Clip  
to fasten Springs to each  
other or to border Wire.  
Length: 7/8"  
For 1/4" or two 8 Gauge Wires.

UNIT PACKAGE: 100



**11795**

Zinc

Seat Cover Clip  
GM 1978-On

UNIT PACKAGE: 100



**2850**

Front Seat  
Self-Locking Clip  
Ford

UNIT PACKAGE: 100



**8665**

Front Seat  
Rod End Nut  
Outer Diameter: 15/16"  
Stud Size 1/2"  
Chrysler

UNIT PACKAGE: 100



**8719**

(4000155)  
Nickel

Front Seat Inner Bracket Nut  
Outer Diameter: 11/16"  
Stud Size: 3/8"  
Rambler

UNIT PACKAGE: 100



**2672**

Front Seat  
Hinge Arm Clip  
GM

UNIT PACKAGE: 100



**Grommets and Washers**  
Solid Brass

|             |            |            |
|-------------|------------|------------|
| <b>7347</b> | 3/8" Hole  | Size No. 2 |
| <b>7348</b> | 7/16" Hole | Size No. 3 |
| <b>7349</b> | 1/2" Hole  | Size No. 4 |
| <b>7350</b> | 5/8" Hole  | Size No. 5 |

NOTE: Grommets and Washers bagged separately.

UNIT PACKAGE: 144 Grommets & 144 Washers



**Grommet  
Setting Dies**



|                                |                       |
|--------------------------------|-----------------------|
| <b>7342</b> - For Grommet 7348 | 7/16" Hole-Size No. 3 |
| <b>7343</b> - For Grommet 7349 | 1/2" Hole-Size No. 4  |
| <b>7344</b> - For Grommet 7350 | 5/8" Hole-Size No. 5  |

UNIT PACKAGE: 1 SET



**Flanged Type  
Countersunk Washers**

| Screw Size | I.D.   | O.D.   | Nickel on Brass Part No. | Black Zinc on Brass Part No. | Stainless Steel Part No. | Unit Pkg. |
|------------|--------|--------|--------------------------|------------------------------|--------------------------|-----------|
| #6         | 5/32"  | 1/2"   | <b>3469</b>              |                              | <b>3470</b>              | 100       |
| #8         | 13/64" | 5/8"   | <b>2515</b>              | <b>16009</b>                 | <b>2597</b>              | 100       |
| #10        | 1/4"   | 11/16" | <b>3471</b>              |                              | <b>3472</b>              | 100       |



**Flush Type Washers**  
Nickel Plated on Brass

| Unit Pkg.    | Unit Pkg.   | Unit Pkg.    | Screw Size | I.D.   | O.D.   |
|--------------|-------------|--------------|------------|--------|--------|
| 100          | 144         | 1000         |            |        |        |
| <b>602</b>   | <b>7137</b> | <b>7624</b>  | #6         | 5/32"  | 11/32" |
| <b>604</b>   | <b>7138</b> | <b>7625</b>  | #8         | 3/16"  | 3/8"   |
| <b>16015</b> |             | <b>16016</b> | #10        | 13/64" | 15/32" |



**Countersunk Type Washers**

| Screw Size | I.D.   | O.D.   | Nickel Plated Brass |               |                | Black Zinc Plated Brass |           | Plain Brass  |           |
|------------|--------|--------|---------------------|---------------|----------------|-------------------------|-----------|--------------|-----------|
|            |        |        | Unit Pkg. 100       | Unit Pkg. 144 | Unit Pkg. 1000 | Part No.                | Unit Pkg. | Part No.     | Unit Pkg. |
| #4         | 9/64"  | 3/8"   | <b>612</b>          |               | <b>7613</b>    |                         |           |              |           |
| #6         | 11/64" | 7/16"  | <b>614</b>          | <b>7143</b>   | <b>7615</b>    | <b>16011</b>            | 100       |              |           |
| #8         | 13/64" | 1/2"   | <b>616</b>          | <b>7145</b>   | <b>7616</b>    | <b>16012</b>            | 100       |              |           |
| #10        | 1/4"   | 19/32" | <b>618</b>          | <b>7147</b>   | <b>7618</b>    | <b>16013</b>            | 100       | <b>16593</b> | 100       |
| #12        | 9/32"  | 11/16" | <b>619</b>          | <b>7148</b>   |                |                         |           |              |           |

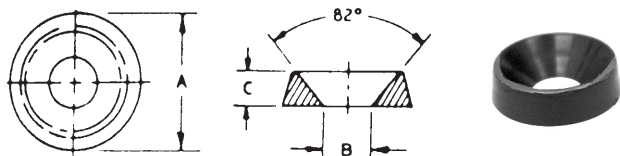

## Nylon Finishing Washers

Available in natural or black nylon, these molded washers protect cabinets from scratching, cover misaligned holes, etc. May also be used as guides, bumpers and spacers.

| Auveco Part No. | Screw Size | O.D. (A)        | I.D. (B)       | Thickness (C)  | Color   | Unit Pkg. |
|-----------------|------------|-----------------|----------------|----------------|---------|-----------|
| <b>13717</b>    | #6         | .437" (11.10mm) | .143" (3.63mm) | .100" (2.54mm) | Black   | 50        |
| <b>13718</b>    | #8         | .515" (13.08mm) | .171" (4.34mm) | .115" (2.92mm) | Natural | 50        |
| <b>13719</b>    | #8         | .515" (13.08mm) | .171" (4.34mm) | .115" (2.92mm) | Black   | 50        |
| <b>13720</b>    | #10        | .580" (14.73mm) | .191" (4.85mm) | .152" (3.86mm) | Natural | 50        |
| <b>13721</b>    | #10        | .580" (14.73mm) | .191" (4.85mm) | .152" (3.86mm) | Black   | 50        |
| <b>13723</b>    | #12        | .609" (15.47mm) | .225" (5.72mm) | .160" (4.06mm) | Black   | 50        |
| <b>13724</b>    | #14        | .683" (17.35mm) | .251" (6.38mm) | .183" (4.65mm) | Natural | 50        |
| <b>13725</b>    | #14        | .683" (17.35mm) | .251" (6.38mm) | .183" (4.65mm) | Black   | 50        |

### Pop on Screw Covers & Bases

Covers: Matte Finish



Ultra Violet Stabilized Polypropylene covers and bases help shield screws from corrosive environments. Their smooth finish forms a protective barrier against rough-edges. For use with flat head and oval head tap ping screws and round head machine screws.

They're simple to use:

1. Place washer over pilot or starting hole for screw, nail or rivet.
2. Install fastener
3. Place Snap Cap over washer at slight angle.
4. Simply push Snap Cap down firmly.

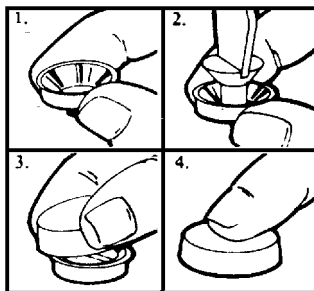

### Screw Cover Bases

| Auveco Part No. | Unit Pkg. | Screw Size |
|-----------------|-----------|------------|
| <b>13839</b>    | 50        | #4         |
| <b>13840</b>    | 50        | #6         |
| <b>13841</b>    | 50        | #8         |
| <b>13842</b>    | 50        | #10        |

### Screw Covers

| Auveco Part No. | Unit Pkg. | Color |
|-----------------|-----------|-------|
| <b>13831*</b>   | 50        | Black |
| <b>13832*</b>   | 50        | White |
| <b>13833*</b>   | 50        | Black |
| <b>13834*</b>   | 50        | White |
| <b>13835•</b>   | 50        | Black |
| <b>13836•</b>   | 50        | White |
| <b>13837•</b>   | 50        | Black |
| <b>13838•</b>   | 50        | White |

\* 1/2" O.D.

• 5/8" O.D.



**19413**  
(F7UZ-15238A32)  
Black Nylon

Door Panel Screw Cover  
Head Diameter: 3/4" (19mm)  
Fits into 5/8" (16mm) Hole  
Ford Econoline E150 1997-On

UNIT PACKAGE: 25

### Accessories for use on Landau Tops



**9877**

Stainless Steel

#4-24 x 3/8"

Head Diameter: 7/32"

Type AB

Used in place of Welded Studs on Landau Tops

UNIT PACKAGE: 100



**9850**

(7731589)

Natural Nylon

Landau Top Moulding Clip  
Use with Auveco Screw 9877

UNIT PACKAGE: 100



**10632**

Nylon

Landau Top Moulding Clip  
Use with Auveco Screw 9877

UNIT PACKAGE: 100



**11485**

(1729250)

Nylon

Roof Transverse Moulding Clip  
GM 1976-On

UNIT PACKAGE: 25

**9342**(4459049)  
NylonDoor Trim Pad Grommet  
Screw Size: #8 or #10  
Stem Length: 9/16"  
Buick & Oldsmobile

UNIT PACKAGE: 50

**3617**(6280765)  
NylonDoor Trim Pad Grommet  
Screw Size: #4  
Stem Length: 7/16"  
Chevrolet & Oldsmobile

UNIT PACKAGE: 100

**18398**(20058837)  
NylonWindshield Upper  
Garnish Clip  
GM A & G Models  
1988-78

UNIT PACKAGE: 10

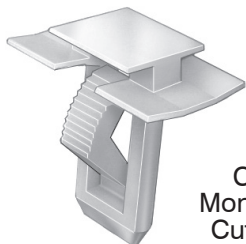
**16865**(20462090)  
NylonGarnish Moulding Clip  
Buick Century & Regal,  
Chevrolet Camaro, Celebrity,  
Monte Carlo & Malibu, Oldsmobile  
Cutlass & Ciera, Pontiac Firebird  
Grand Prix & 6000 1978-On

UNIT PACKAGE: 25

**11118**(9617200)  
NylonHeadliner Clip  
Inner Side Front, Center & Rear  
GM 1973-On

UNIT PACKAGE: 10

**11119**

Same as 11118 except for unit package quantity

UNIT PACKAGE: 100

**17666**(20632190)  
NylonGarnish Moulding Clip  
Back Window Upper & Side  
Moulding GarnishBuick LeSabre, Cadillac, Fleetwood Brougham,  
Chevrolet Caprice & Impala, Olds Delta 88 & 98,  
Pontiac Bonneville & Parisienne 1989-80

UNIT PACKAGE: 10

## HAVE YOU VISITED US ONLINE?

**Auveco's website has been completely renovated.****Our new design is user friendly with easy navigation and ordering.****Product is searchable by car make, OEM number and category, as well as, several attribute drop downs within individual categories. All product also has stock availability listed.****Make sure to head over to****[www.auveco.com](http://www.auveco.com)****to receive up to date information on all our products.**



Button  
Nickel on Brass  
11/64" Barrel Length

**14830** - Black Delrin Cap  
UNIT PACKAGE: 50

**7677** - Nickel Cap  
UNIT PACKAGE: 100



Socket  
Nickel on Brass

**7678** - Normal Action  
UNIT PACKAGE: 100



Stud  
Nickel on Brass

**7679** - Clinch Type  
UNIT PACKAGE: 100



Eyelet  
Nickel on Brass

**7682** - 1/4" Barrel Length  
UNIT PACKAGE: 100

Buttons 7677 and 14830 assemble with socket 7678.

You can use hand tools 7690 and 7691 or hand press tool 14835 to complete this step.

Stud 7679 assembles with eyelet 7682.

You can use hand tools 7691 and 7692 or hand press tool 14835 to perform this step.

The two assembled units then snap together.

An assembled button (7677, 14830) and socket (7678) unit can be used with fasteners listed below.



Phillips Wood Screw  
Nickel on Brass

**9814** - #8 x 3/8"  
**7680** - #8 x 5/8"  
UNIT PACKAGE: 100



Phillips Head  
Stainless Steel Screw

**14833** - #8 x 3/8"  
**14834** - #8 x 5/8"  
**15687** - #10 x 5/8"  
UNIT PACKAGE: 50



Phillips Head  
Stainless Steel Screw

**16418** - #8 x 1/2"  
Nickel on Brass

**16419** - #8 x 3/4"  
Stainless Steel Screw

UNIT PACKAGE: 25



Wood Screw Stud  
Nickel on Brass

**7688** - #7 x 1/2"  
UNIT PACKAGE: 100



**7690**

Height: 5/8"  
Diameter: 1-3/8"  
Die for assembling buttons 7677 & 14830 with socket 7678. The button sets in the die. Then the material and socket are placed over the button barrel. Tool 7691 is used to swedge over the barrel.  
UNIT PACKAGE: 1



**7692**

Height: 5/8"  
Diameter: 1-3/8"  
Die for assembling stud 7679 and eyelet 7682. The eyelet sets in the die. Then the material and stud are placed over the eyelet barrel. Tool 7691 is used to swedge over the barrel.  
UNIT PACKAGE: 1



**7691**

Length: 3-1/4"  
Tool for assembling buttons 7677 & 14830 with socket 7678 and stud 7679 with eyelet 7682.

UNIT PACKAGE: 1

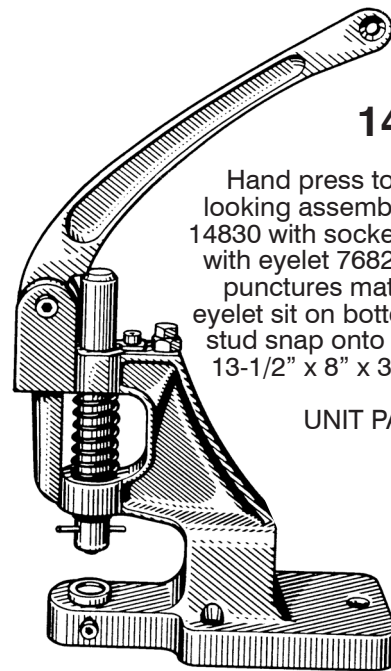

**14835**

Hand press tool for professional looking assembly of buttons 7677 & 14830 with socket 7678 and stud 7679 with eyelet 7682. Tool automatically punctures material. Buttons and eyelet sit on bottom dies. Socket and stud snap onto dies on the plunger. 13-1/2" x 8" x 3-1/2". Weighs 8 lbs.

UNIT PACKAGE: 1

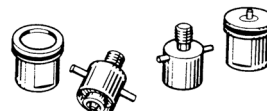

**CURTAIN FASTENERS**

Nickel on Brass



**7417**

Backplate  
Single curtain to  
clinch with backplate

UNIT PACKAGE: 100

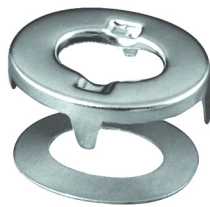

**7409**

Eyelets & washers  
**Use with Auveco Fasteners  
7417 and 7419**

UNIT PACKAGE: 100 Sets



**7419**

Single curtain  
Use with #4 stainless steel,  
chrome or brass screws  
(screws sold separately)

UNIT PACKAGE: 100



**7432**

*Photo not actual size*  
Tool for cutting holes in material when  
installing 7409 eyelet and washer.  
Overall Length: 6-11/16"

UNIT PACKAGE: 1

**TRIMMING SUNDRIES & FASTENERS**

Refer to Retainer Specification Chart on pages 404 - 413



**19746**

(91652-SZ3-003)  
White Nylon

Door Lining Retainer  
Acura 3.5RL 1996 - On

UNIT PACKAGE: 10



**21548**

(67869-20030)  
Black Nylon

Weatherstrip Retainer  
Lexus IS 300 & SC 430 and Toyota Camry,  
Celica, Corolla, Highlander, Matrix, MR-2, Prius,  
RAV-4, Scion, Solara & Supra 1990 - On

UNIT PACKAGE: 25



**18684**

(10262036)  
Black Nylon

Control Panel Trim Retainer  
Chevrolet Lumina & Monte Carlo 1995-On

UNIT PACKAGE: 100



**14367**

(9924-90-512B)  
Black Nylon

Retainer  
Mazda

UNIT PACKAGE: 50



**21627**

(67868-30030)  
Black Nylon

Door & Roof Rail Retainer  
Lexus 2006 - On & Toyota 1974 - On

UNIT PACKAGE: 25



**21984**

(VW: 6Y0-823-717)  
Black Nylon

Trim Panel Retainer  
VW, Audi, SEAT & Skoda

UNIT PACKAGE: 15



**21458**

(91567-S3M-000)  
Black Nylon

Weatherstrip Retainer  
Honda Accord, Civic & Odyssey 2003 - On

UNIT PACKAGE: 25



**18683**

(10063599)  
Black Nylon

Remote Control Door  
Lock Receiver Retainer  
Chevrolet Lumina & Monte Carlo,  
Oldsmobile Cutlass and Pontiac  
Bonneville & Grand Prix 1991 - On

UNIT PACKAGE: 100



**19686**

(90467-05045-22)  
Black Nylon

Weatherstrip Retainer  
Toyota Solara 1998 - On

UNIT PACKAGE: 25

# TRIMMING SUNDRIES & FASTENERS

Sec. 19

Refer to Retainer Specification Chart on pages 475-489



**18770**

(3759944)  
Black Nylon

Cowl & Dash Panel Retainer  
Dodge Shadow & Plymouth Sundance  
1988 - On

UNIT PACKAGE: 50



**20344**

(10169777)  
Black Nylon

Weatherstrip Retainer  
**Replaces Auveco 18322**  
Chevrolet Impala, Lumina & Monte Carlo  
and Pontiac Aztek 1995 - On

UNIT PACKAGE: 25



**14921**

(GM: 20699808; Chry: 6502328)  
Black Nylon

Door Weatherstrip Retainer  
GM 1974 - On  
Dodge Ram 1994 - On

UNIT PACKAGE: 50



**18389**

(25603960)  
Black Nylon

Radiator Baffle  
Retainer  
Olds 98 Regency 1994 - On

UNIT PACKAGE: 25



**20165**

(4658887)  
Black Nylon

Trim Panel Retainer  
Chrysler LH & LHS Series 1997 - On

UNIT PACKAGE: 50



**14021**

(N803170-S)  
Black Nylon

Fascia Retainer  
Ford Mustang & Capri 1984 - On

UNIT PACKAGE: 25



**20528**

(24205245)  
Black Nylon

Rear Bumper Cover Retainer  
Chevrolet Cavalier & Pontiac Sunfire  
1995 - On

UNIT PACKAGE: 50



**21936**

(Peugeot & Citroen: 6992.07)  
Black Nylon

Trim Panel Retainer  
Peugeot & Citroen

UNIT PACKAGE: 25



**11129**

(2964547)  
Black Nylon

Weatherstrip Retainer  
Chrysler 1977 - On

UNIT PACKAGE: 25



**11120**

(8731909)  
Black Nylon

Door Weatherstrip Retainer  
GM 1963 - On

UNIT PACKAGE: 100



**21808**

(Peugeot & Citroen: 6992.31)  
White Nylon

Interior Trim Retainer  
Peugeot & Citroen

UNIT PACKAGE: 25



**18302**

(GM: 20538173; Chry: 6104908-AA;  
Mercedes: 002-997-33-86-67)  
Black Nylon

Weatherstrip Retainer  
Buick Century & Riviera, Chevrolet Lumina, Olds  
Aurora & Regency and Pontiac Grand Prix 1989 - On  
Chrysler 2008 - On  
Mercedes-Benz

UNIT PACKAGE: 50



## Sec. 19

# TRIMMING SUNDRIES & FASTENERS

Refer to Retainer Specification Chart on pages 475-489



**21855**

(Land Rover: MXC1800)  
Black Nylon

Door Panel Retainer  
Defender & Discovery Series 1997 - On

UNIT PACKAGE: 15



**21770**

(Land Rover: MWC9134)  
Black Nylon

Side Door Trim Panel Retainer  
**Use with Auveco 22085**  
Defender Series, Discovery Series,  
Freelander & Range Rover 2006 - 1989

UNIT PACKAGE: 25



**14006**

(20455900)  
Black Nylon

Moulding Retainer  
GM 1984 - On

UNIT PACKAGE: 25



**21519**

(01553-01A50)  
Black Nylon

Bumper & Trim Retainer  
Infiniti FX35, G35, G37, M35, M45 & Q45  
and Nissan 350Z & 370Z 1997 - On

UNIT PACKAGE: 25



**17634**

(01553-01781)  
Black Nylon

Cowl Grille Retainer  
Nissan 240SX 1990 - On

UNIT PACKAGE: 25



**20893**

(GM: 10293193;  
Ford: N811040-S)  
Black Nylon

Hood Insulation &  
Door Weatherstrip Retainer  
Chevrolet Cobalt &  
Ford Mustang 2005 - On

UNIT PACKAGE: 50



**18298**

(22536642)  
Black Nylon

Rear Bumper Fascia Retainer  
Chevy Cavalier, Olds Calais, Pontiac  
Grand Prix, Sunbird & 6000 1988 - On

UNIT PACKAGE: 50



**19673**

(72311-S10-003)  
Black Nylon

Weatherstrip Retainer  
Honda CRV 1997 - On

UNIT PACKAGE: 15



**20311**

(N803857S)  
Black Nylon

Front End Fascia Retainer  
**Replaces Auveco 15483**  
Ford Aerostar, LTD & Marquis 1985 - On

UNIT PACKAGE: 50



**11721**

(411700)  
Black Nylon

Trim Panel Retainer  
GM 1968-On

UNIT PACKAGE: 50



**19149**

(4658673)  
Black Nylon

Weatherstrip Retainer  
Front & Rear Doors  
Chrysler Neon 1996-On

UNIT PACKAGE: 50



**18948**

(GM: 1644290; Nissan: 01553-0075U)  
Black Nylon

Hood Insulation, Rear Bumper Fascia  
& Door Trim Plate Retainer  
GM 1991 - On  
Nissan: 2002 - On

UNIT PACKAGE: 25



**18897**

(10078274)  
Black Nylon

Side Roof Rail  
Weatherstrip Retainer  
Chevrolet Corsica & Beretta 1989 - 87

UNIT PACKAGE: 25

# TRIMMING SUNDRIES & FASTENERS

Sec. 19

Refer to Retainer Specification Chart on pages 475-489



**11680**

(25016383)  
Black Nylon

Dash Panel Retainer  
GM 1977 - On

UNIT PACKAGE: 50



**11612**

(GM: 20413107;  
Ford: 388246S  
AMC: 4006516)  
Black Nylon

Weatherstrip Retainer  
GM, Ford & AMC

UNIT PACKAGE: 50



**14289**

(90666-SA0-003)  
Black Nylon

Retainer  
Honda

UNIT PACKAGE: 25



**19836**

(6505417AA)  
Black Nylon

Trim Panel Retainer  
Chrysler

UNIT PACKAGE: 50



**21800**

(Renault: 77-03-077-080)  
Black Nylon

Retainer  
Renault and Dacia

UNIT PACKAGE: 25



**21801**

(Not Available from O.E.M.)  
White Nylon

Retainer  
Renault and Dacia

UNIT PACKAGE: 25



**12993**

(7703-077-066)  
Black Nylon

Rear Window Moulding  
AMC Renault & Alliance 1983 - On

UNIT PACKAGE: 25



**21802**

(Renault: 77-03-077-231;  
Fiat: 14591787)  
Black Nylon

Retainer  
Renault, Dacia  
and Fiat

UNIT PACKAGE: 25



**21803**

(Fiat: 14592087)  
Black Nylon

Retainer  
Renault, Dacia and Fiat

UNIT PACKAGE: 25



**21804**

(Fiat: 14592086)  
Gray Nylon

Retainer  
Renault, Dacia and Fiat

UNIT PACKAGE: 25



**14017**

(390126-S)  
Black Nylon

Fascia Retainer  
Ford Mustang &  
Capri 1984 - On

UNIT PACKAGE: 25

**14857**

Same as 14017 except for unit package quantity

UNIT PACKAGE: 50

**All items available in bulk quantities.**

**Call customer service 1-800-354-9816  
for a price quote**

**Sec. 19****TRIMMING SUNDRIES & FASTENERS**

Refer to Retainer Specification Chart on pages 475-489

**21878**  
(Peugeot & Citroen: 8964.57)  
Black NylonTrunk Lining Retainer  
Peugeot & Citroen

UNIT PACKAGE: 25

**21693**  
(Lexus: 90467-05125)  
Black NylonFront Bumper Bracket Retainer  
Lexus GS 300, GS 450h  
& LS 400 1995 - On

UNIT PACKAGE: 25

**18682**  
(10098645)  
Black NylonFront Door Lower Moulding Retainer  
Pontiac Grand Prix with  
Sport Performance Package 1994 - On

UNIT PACKAGE: 50

**21303**  
(90671-S0D-003ZK)  
Black NylonTrunk Lid &  
Interior Trim Retainer  
Honda Accord 2010 - On

UNIT PACKAGE: 25

**20256**  
(01553-01182)  
Black NylonSplash Shield Retainer  
Nissan Frontier Truck 1997 - On

UNIT PACKAGE: 50

**21877**  
(Peugeot & Citroen: 6992.C6)  
Black NylonRadiator Panel Retainer  
Peugeot & Citroen

UNIT PACKAGE: 25

**17453**  
(B003-68-865-96)  
Gray NylonRear Compartment  
Interior Trim Retainer  
Ford Probe 1988 - On  
Mazda MX6 1988 - On

UNIT PACKAGE: 50

**21589**  
(99045AE03AMA)  
Black NylonTrim Panel Retainer  
Subaru B9 Tribeca, Impreza,  
Legacy & Outback 2005 - On

UNIT PACKAGE: 25

**21755**  
(Mazda: B003-68-865-00)  
Black NylonTrim Panel Retainer  
MPV 1998 - 89

UNIT PACKAGE: 50

**18815**  
(6502381)  
Black NylonRadiator Grille  
Sight Shield Retainer  
Dodge Caravan &  
Plymouth Voyager 1993 - On

UNIT PACKAGE: 50

**19312**  
(90467-05096-22)  
Black NylonLuggage Compartment  
Trim Panel Retainer  
Toyota Tercel & Paseo 1994 - On

UNIT PACKAGE: 25

**21910**  
(Renault & Dacia: 77-03-077-487)  
Black NylonTrim Panel Retainer  
Renault & Dacia

UNIT PACKAGE: 25

# TRIMMING SUNDRIES & FASTENERS

Sec. 19

Refer to Retainer Specification Chart on pages 475-489



**21911**

(Renault & Dacia: 77-03-077-464)  
Gray Nylon

Trim Panel Retainer  
Renault & Dacia

UNIT PACKAGE: 15



**21912**

(Renault & Dacia: 77-03-077-153)  
Black Nylon

Trim Panel Retainer  
Renault & Dacia

UNIT PACKAGE: 15



**21913**

(Renault & Dacia: 77-03-077-107)  
Dark Gray Nylon

Trim Panel Retainer  
Renault & Dacia

UNIT PACKAGE: 25



**19506**

(90666-SA7-003ZW)  
Black Nylon

Trunk Lining Retainer  
Acura 2.5TL, 3.2TL, 3.5, Integra &  
Legend, Honda Accord Wagon  
& Prelude 1987 - On

UNIT PACKAGE: 15



**21938**

(Peugeot & Citroen: 7588.VX)  
Black Nylon

Trim Panel Retainer  
Peugeot & Citroen

UNIT PACKAGE: 25



**21349**

(85746-06000LX)  
Gray Nylon

Headliner Retainer  
Kia Rio 2010 - On

UNIT PACKAGE: 25



**21350**

(85746-06000RU)  
Tan Nylon

Headliner Retainer  
Kia Rio 2010 - On

UNIT PACKAGE: 25



**15050**

Black Nylon

Shroud Retainer  
High Retention Capability  
GM, Ford & Chrysler

UNIT PACKAGE: 50



**15367**

(20514862)  
Black Nylon

Screen Shroud Vent  
Grille to Panel Retainer  
GM 1985 - On

UNIT PACKAGE: 50



**21940**

(Peugeot & Citroen: 6992.95)  
Black Nylon

Trim Panel Retainer  
Peugeot & Citroen

UNIT PACKAGE: 25



**11675**

(GM: 25514221;  
Chry: 6003587)  
Black Nylon

Roof Headliner Retainer  
GM & Chrysler 1982 - On

UNIT PACKAGE: 50



**21199**

(Ford: W711687-S300;  
GM: 11589181)  
Black Nylon

Bumper and Fender Apron Retainer  
Ford Focus and GM Full-Size  
Pick-Up Trucks 2007 - On

UNIT PACKAGE: 25



**14709**

(Mazda: G030-68-885-B-38;  
Ford: F22Z-16774-A, GA2A-56694)  
Nylon

Hood Insulation Retainer  
Mazda & Ford Probe

UNIT PACKAGE: 25

**Sec. 19****TRIMMING SUNDRIES & FASTENERS**

Refer to Retainer Specification Chart on pages 475-489

**21661**  
(TD11-56-694)  
Black NylonHood Insulation Retainer  
Mazda 3, 5, 6, CX7, CX9,  
MX5 Miata & RX8 2004 - On

UNIT PACKAGE: 25

**13198**  
(4-29-29-06)  
Black NylonInterior Trim Retainer  
Fiat

UNIT PACKAGE: 50

**20399**  
(W701374-S)  
Black NylonHood Insulation Retainer  
Ford Escape 2001 - On

UNIT PACKAGE: 25

**18820**  
(N807951S)  
Black NylonAccess Hole Cover Retainer  
Ford Mustang 1994 - On

UNIT PACKAGE: 100

**11679**  
(GM: 20032850; Ford: 387258-S;  
Chry: 3861577)  
Black NylonMud Shield Retainer  
GM, Ford & Chrysler 1976 - On

UNIT PACKAGE: 100

**19667**  
(N801994-S100)  
Black NylonTrim Panel Retainer  
Ford 1982 - On

UNIT PACKAGE: 25

**13454**  
(20511451)  
Black NylonCowl Vent Retainer  
GM 1984 - On

UNIT PACKAGE: 25

**21941**  
(Peugeot & Citroen: 9128.S1)  
Light Gray NylonTrim Panel Retainer  
Peugeot & Citroen

UNIT PACKAGE: 10

**11347**  
(3861577)  
Black NylonFront Seat Adjuster Cover Retainer  
Chrysler 1975 - On

UNIT PACKAGE: 25

**21937**  
(Peugeot & Citroen: 6992.W9)  
Black NylonTrim Panel Retainer  
Peugeot & Citroen

UNIT PACKAGE: 25

**19643**  
(90467-06175)  
Black NylonLuggage Compartment  
Retainer  
Toyota Solara 1998 - On

UNIT PACKAGE: 15

**21939**  
(Peugeot & Citroen: 7589.V4)  
Tan NylonTrim Panel Retainer  
Peugeot & Citroen

UNIT PACKAGE: 15

**20184**  
(90467-08186)  
Black NylonLuggage Compartment  
Trim Retainer  
Toyota Camry 1999 - On

UNIT PACKAGE: 25