

4.4" Ultra-Thin Strobe

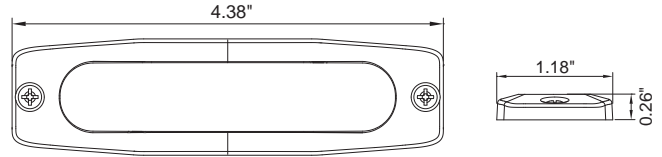

- Includes 3M™ Self Adhesive Tape



	Part No.	Size	LEDs	Color	Amp	Flash	Housing	Wt. (lbs.)	Cat.
	8892240	4.4"	4	Amber	0.65	23 Patterns	Aluminum	0.10	889 (N)
	8892241	4.4"	4	Clear	0.65	23 Patterns	Aluminum	0.10	889 (N)
	8892242*	4.4"	4	Amber/Clear	0.65	23 Patterns	Aluminum	0.10	889 (N)
	8892243	4.4"	4	Red	0.65	23 Patterns	Aluminum	0.10	889 (N)
	8892244	4.4"	4	Blue	0.65	23 Patterns	Aluminum	0.10	889 (N)
NEW	8892245*	4.4"	4	Red/Blue	0.65	23 Patterns	Aluminum	0.10	889 (N)
	8892246*	4.4"	4	Amber/Red	0.65	23 Patterns	Aluminum	0.10	889 (N)
	8892247*	4.4"	4	Clear/Red	0.65	23 Patterns	Aluminum	0.10	889 (N)
	8892248*	4.4"	4	Amber/Blue	0.65	23 Patterns	Aluminum	0.10	889 (N)
	8892249*	4.4"	4	Green	0.65	23 Patterns	Aluminum	0.10	889 (N)
	8892250*	4.4"	4	Amber/Green	0.65	23 Patterns	Aluminum	0.10	889 (N)
	8892255	Black, 90 Degree Mounting Bracket						0.04	889 (N)

* These color combinations are not CA13 or SAE J595 Class 1

4.75" Mini Strobe



- Includes 3M™ Self Adhesive Tape

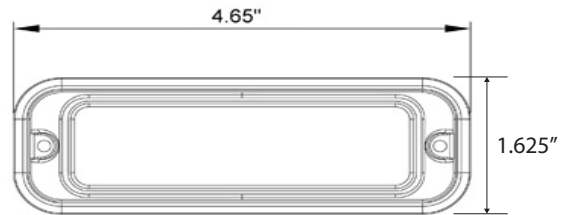

	Part No.	Size	LEDs	Color	Amp	Flash	Housing	Wt. (lbs.)	Cat.
	8891130	4.75"	4	Amber	0.4	19 Patterns	Plastic	0.24	889 (N)
	8891131	4.75"	4	Clear	0.4	19 Patterns	Plastic	0.24	889 (N)
	8891132*	4.75"	4	Amber/Clear	0.4	19 Patterns	Plastic	0.24	889 (N)
	8891135	Black, 90 Degree Mounting Bracket						0.04	889 (N)

* 8891132 is not CA13 or SAE J595 Class 1

LED Surface Mount Strobes

4.875" Rectangular Strobe

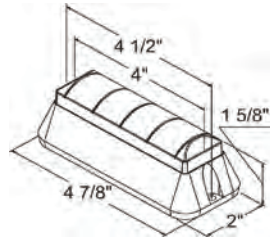

	Part No.	Size	LEDs	Color	Amp	Flash	Housing	Wt. (lbs.)	Cat.
	8891004	4-7/8"	4	Amber	0.54	Quad Flash Pattern	Aluminum	0.60	889 (N)
	8891006	4-7/8"	4	Clear	0.54	Quad Flash Pattern	Aluminum	0.60	889 (N)
	8891008	4-7/8"	4	Red	0.54	Quad Flash Pattern	Aluminum	0.60	889 (N)
	8891009	4-7/8"	4	Blue	0.54	Quad Flash Pattern	Aluminum	0.60	889 (N)
	Part No.	Description						Wt. (lbs.)	Cat.
	8891007	Aluminum, 90 Degree Mounting Bracket						0.16	889 (N)

4.875" Rectangular Strobe

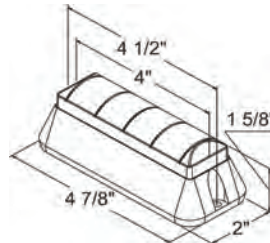

	Part No.	Size	LEDs	Color	Amp	Flash	Housing	Wt. (lbs.)	Cat.
	8891104	4-7/8"	4	Amber	0.54	19 Flash Patterns	Aluminum	0.60	889 (N)
	8891105	4-7/8"	4	Amber/Clear	0.54	19 Flash Patterns	Aluminum	0.60	889 (N)
	Part No.	Description						Wt. (lbs.)	Cat.
	8891007	Aluminum, 90 Degree Mounting Bracket						0.16	889 (N)

2.25" Stick-on Rectangular Strobe

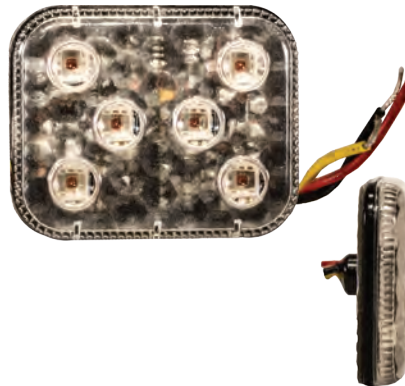

Low Profile

	Part No.	Size	LEDs	Color	Amp	Flash	Housing	Wt. (lbs.)	Cat.
	8892500	2.25"	6	Amber	0.30	6X Pattern	Plastic	0.09	889 (N)
	8892501	2.25"	6	Clear	0.30	6X Pattern	Plastic	0.09	889 (N)

NEW

5" Mini Strobe

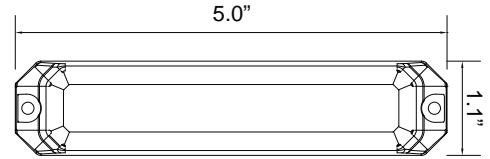

	Part No.	Size	LEDs	Color	Amp	Flash	Housing	Wt. (lbs.)	Cat.
	8891500	5"	6	Amber	1.1	19 Patterns	Aluminum	0.25	889 (N)
	8891501	5"	6	Clear	1.1	19 Patterns	Aluminum	0.25	889 (N)
	8891502*	5"	6	Amber/Clear	1.1	19 Patterns	Aluminum	0.25	889 (N)
	Part No.	Description						Wt. (lbs.)	Cat.
	8891505	Grommet						0.25	889 (N)
	8891506	Black, 90 Degree Mounting Bracket						0.16	889 (N)

*8891502 is not CA13 or SAE J595 Class 1

4.4" Thin Mount Horizontal Strobe

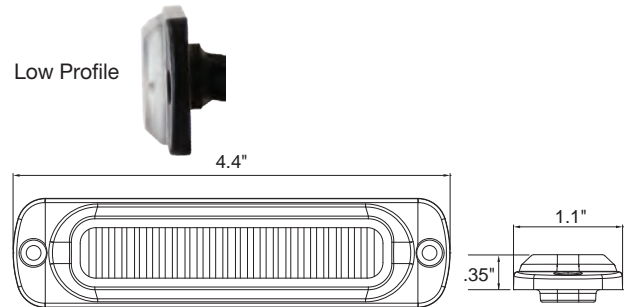

	Part No.	Size	LEDs	Color	Amp	Flash	Housing	Wt. (lbs.)	Cat.
	8891900	4.4"	6	Amber	1.0	19 Patterns	Aluminum	0.09	889 (N)
	8891901	4.4"	6	Clear	1.0	19 Patterns	Aluminum	0.09	889 (N)
	8891902*	4.4"	6	Amber/Clear	1.0	19 Patterns	Aluminum	0.09	889 (N)
	8891903	4.4"	6	Red	1.0	19 Patterns	Aluminum	0.09	889 (N)
	8891904	4.4"	6	Blue	1.0	19 Patterns	Aluminum	0.09	889 (N)

Strobes must be mounted in horizontal orientation to achieve Class 1 rating

*8891902 is not CA13 or SAE J595 Class 1

	Part No.	Description						Wt. (lbs.)	Cat.
	8891920	Chrome bezel for thin mount LED Lights						0.02	889 (N)
	8891921	White PVC bezel for thin mount LED lights						0.03	889 (N)
	8891925	Black, 90 Degree Mounting Bracket						0.06	889 (N)

LED Surface Mount Strobes

4.4" Thin Mount Vertical Strobe



Part No.	Size	LEDs	Color	Amp	Flash	Housing	Wt. (lbs.)	Cat.
8891910	4.4"	6	Amber	1.0	19 Patterns	Aluminum	0.09	889 (N)
8891911	4.4"	6	Clear	1.0	19 Patterns	Aluminum	0.09	889 (N)
8891912*	4.4"	6	Amber/Clear	1.0	19 Patterns	Aluminum	0.09	889 (N)
8891913	4.4"	6	Red	1.0	19 Patterns	Aluminum	0.09	889 (N)
8891914	4.4"	6	Blue	1.0	19 Patterns	Aluminum	0.09	889 (N)

*Strobes must be mounted in vertical orientation to achieve Class 1 rating
* 8891912 is not CA13 or SAE Class 1*

Part No.	Description	Wt. (lbs.)	Cat.
8891920	Chrome Bezel for Thin Mount LED Lights	0.02	889 (N)
8891921	White PVC Bezel for Thin Mount LED Lights	0.03	889 (N)
8891925	Aluminum, 90 Degree Mounting Bracket	0.06	889 (N)

5.14" Thin Mount Strobe



• Includes 3M™ Self Adhesive Tape

Part No.	Size	LEDs	Color	Amp	Flash	Housing	Wt. (lbs.)	Cat.
8892200	5.14"	6	Amber	1.0	23 Patterns	Aluminum	0.09	889 (N)
8892201	5.14"	6	Clear	1.0	23 Patterns	Aluminum	0.09	889 (N)
8892202*	5.14"	6	Amber/Clear	1.0	23 Patterns	Aluminum	0.09	889 (N)
8892203	5.14"	6	Red	1.0	23 Patterns	Aluminum	0.09	889 (N)
8892204	5.14"	6	Blue	1.0	23 Patterns	Aluminum	0.09	889 (N)
8892205*	5.14"	6	Red/Blue	1.0	23 Patterns	Aluminum	0.09	889 (N)
8892206*	5.14"	6	Amber/Red	1.0	23 Patterns	Aluminum	0.09	889 (N)
8892207*	5.14"	6	Clear/Red	1.0	23 Patterns	Aluminum	0.09	889 (N)
8892208*	5.14"	6	Amber/Blue	1.0	23 Patterns	Aluminum	0.09	889 (N)
8892209	5.14"	6	Green	1.0	23 Patterns	Aluminum	0.09	889 (N)
8892210*	5.14"	6	Amber/Green	1.0	23 Patterns	Aluminum	0.09	889 (N)

Part No.	Description	Wt. (lbs.)	Cat.
8892225	Black Mounting Bracket for Thin Mount LED Lights	0.07	889 (N)

These color combinations are not CA13 or SAE J595 Class 1

5.5" Rectangular Strobe

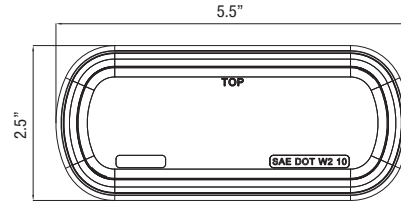

	Part No.	Size	LEDs	Color	Amp	Flash	Housing	Wt. (lbs.)	Cat.
	8891600	5.5"	12	Amber	1.0	12 Patterns	Plastic	0.42	889 (N)
	8891601	5.5"	12	Clear	1.0	12 Patterns	Plastic	0.42	889 (N)
	8891602*	5.5"	12	Amber/Clear	1.0	12 Patterns	Plastic	0.42	889 (N)
	Part No.	Description						Wt. (lbs.)	Cat.
	8891605	Aluminum, 90 Degree Mounting Bracket						0.16	889 (N)

* 8891602 is not CA13 or SAE J595 Class 1

5.19" Rectangular Strobe

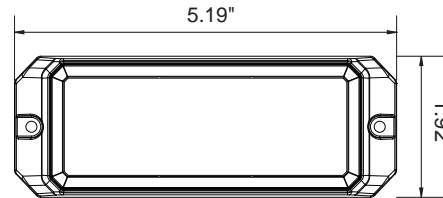
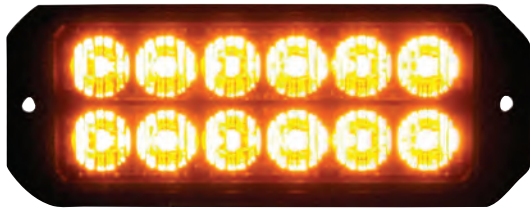

	Part No.	Size	LEDs	Color	Amp	Flash	Housing	Wt. (lbs.)	Cat.
	8891700	5.19"	12	Amber	2.2	25 Patterns	Aluminum	0.42	889 (N)
	8891701	5.19"	12	Clear	2.2	25 Patterns	Aluminum	0.42	889 (N)
	8891702*	5.19"	12	Amber/Clear	2.2	25 Patterns	Aluminum	0.42	889 (N)
	8891703	5.19"	12	Red	2.2	25 Patterns	Aluminum	0.42	889 (N)
	8891704	5.19"	12	Blue	2.2	25 Patterns	Aluminum	0.42	889 (N)
	8891707*	5.19"	12	Blue/Red	2.2	25 Patterns	Aluminum	0.42	889 (N)
	8891709*	5.19"	12	Amber/Green	2.2	25 Patterns	Aluminum	0.42	889 (N)
	Part No.	Description						Wt. (lbs.)	Cat.
	8891705	Recessed Mount, Black Grommet for 8891701 & 8891702						0.12	889 (N)
	8891706	Black, 90 Degree Mounting Bracket						0.70	889 (N)

*These color combinations are not CA13 or SAE J595 Class 1

LED Surface Mount Strobes

5.19" Thin Mount Rectangular Strobe

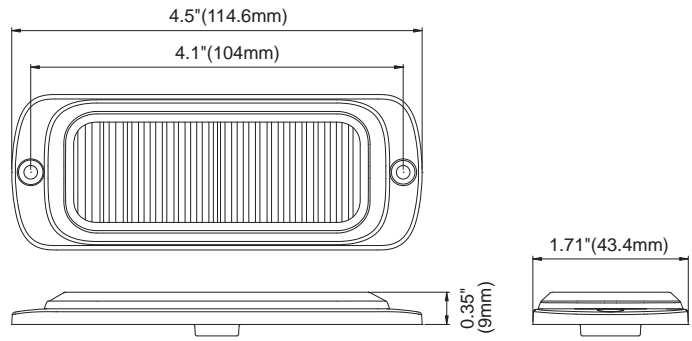

	Part No.	Size	LEDs	Color	Amp	Flash	Housing	Wt. (lbs.)	Cat.
	8892600	4.5"	12	Amber	0.78	25 Patterns	Aluminum	0.21	889 (N)
NEW	8892601	4.5"	12	Clear	0.78	25 Patterns	Aluminum	0.21	889 (N)
	8892602*	4.5"	12	Amber/Clear	0.78	25 Patterns	Aluminum	0.21	889 (N)

8892602 is not CA13 or J595 Class 1

2.85" Post Mount Strobe

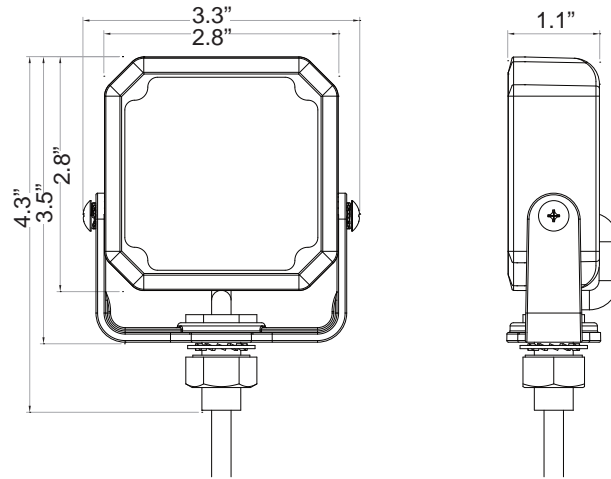

	Part No.	Size	LEDs	Color	Amp	Flash	Housing	Wt. (lbs.)	Cat.
	8891800	2.85"	4	Amber	.55	19 Patterns	Aluminum	0.65	889 (N)
	8891801*	2.85"	4	Clear	.55	19 Patterns	Aluminum	0.65	889 (N)
	8891802**	2.85"	4	Amber/Clear	.55	19 Patterns	Aluminum	0.65	889 (N)
	8891803	2.85"	4	Red	.55	19 Patterns	Aluminum	0.65	889 (N)
	8891804	2.85"	4	Blue	.55	19 Patterns	Aluminum	0.65	889 (N)

* Alternate "Steady ON" Pattern Provides Floodlight Feature

**8891802 is not CA13 or J595 Class 1

4.6" Round Post Mount Strobe

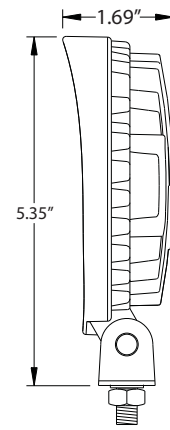
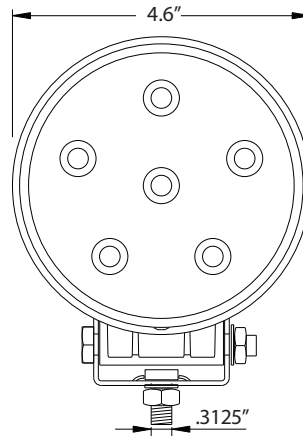





Part No.	Size	LEDs	Color	Amp	Flash	Housing	Wt. (lbs.)	Cat.
8891015	4"	6	Amber	1.5	Flash Pattern	Aluminum	1.20	889 (N)

Surface Mount Strobe/Marker Lights

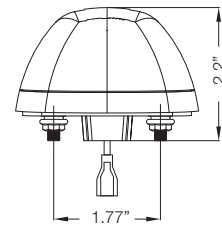
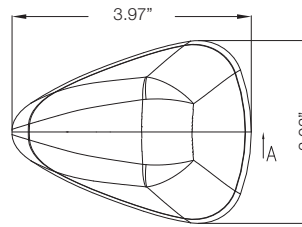

- Set of 5 includes adapter harness and flasher.



Part No.	LEDs	Lens Color	Amp	Flash	Specifications	Wt. (lbs.)	Cat.
 8892000 (Set of 5)	9 Amber per light	Amber	.36	13 Patterns	For 2008-2017 F-250 to F-750	2.30	889 (N)
 8892001 (Set of 5)	9 Amber per light	Clear	.36	13 Patterns	For 2008-2017 F-250 to F-750	2.30	889 (N)
 8892002 (Set of 5)	9 Amber per light	Smoke	.36	13 Patterns	For 2008-2017 F-250 to F-750	2.30	889 (N)

LED Recessed & Hidden Strobes

Bolt-On Hidden Strobe Kits with In-Line Flashers



- 2 lighthoods per kit

Part No.	Size	LEDs	Color	Amp	Flash	Housing	Wt. (lbs.)	Cat.
8891215	15'	6	Clear	1.3	19 Patterns	Aluminum	1.25	889 (N)
8891225	25'	6	Clear	1.3	19 Patterns	Aluminum	1.60	889 (N)
8891216	15'	6	Amber	1.3	19 Patterns	Aluminum	1.25	889 (N)
8891226	25'	6	Amber	1.3	19 Patterns	Aluminum	1.60	889 (N)
8891227	25'	6	Amber/Clear	1.3	19 Patterns	Aluminum	1.60	889 (N)

Note: Up to six 8891215-8891327 can be combined for synchronized or alternating flash patterns.



Part No.	Description
8891200	1 Pair, Chrome, Surface Mount for Bolt-On Hidden Strobes
8891201	1 Pair, Black, Surface Mount for Bolt-On Hidden Strobes (Included w/8892400, 8892401, 8892403 & 8892304)

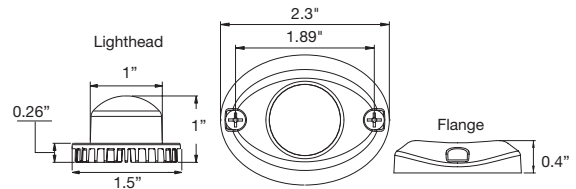

Push-On Hidden Strobes with In-Line Flashers



- 2 Per Kit

Part No.	Size	LEDs	Color	Amp	Flash	Housing	Wt. (lbs.)	Cat.
8891325	25'	6	Clear	1.3	19 Patterns	Aluminum	1.60	889 (N)
8891326	25'	6	Amber	1.3	19 Patterns	Aluminum	1.60	889 (N)
8891327	25'	6	Amber/Clear	1.3	19 Patterns	Aluminum	1.60	889 (N)

Note: Up to six 8891215-8891327 can be combined for synchronized or alternating flash patterns.

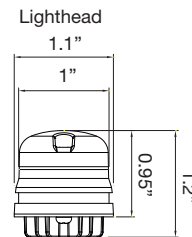

Surface/Recess Mount Strobe Lights



Part No.	Size	LEDs	Color	Amp	Flash	Housing	Wt. (lbs.)	Cat.
8892400	1" round	3	Amber	.47	12 Patterns	Aluminum	0.10	889 (N)
8892401	1" round	3	Clear	.47	12 Patterns	Aluminum	0.10	889 (N)
8892403	1" round	3	Red	.47	12 Patterns	Aluminum	0.10	889 (N)
8892404	1" round	3	Blue	.47	12 Patterns	Aluminum	0.10	889 (N)
8892420	Chrome Bezel						0.10	889 (N)
8892425	Black Aluminum Mounting Bracket, 90 Degree (Included w/8892400, 8892401, 8892403 & 8892304)						0.05	889 (N)

Rectangular Mini Lightbar

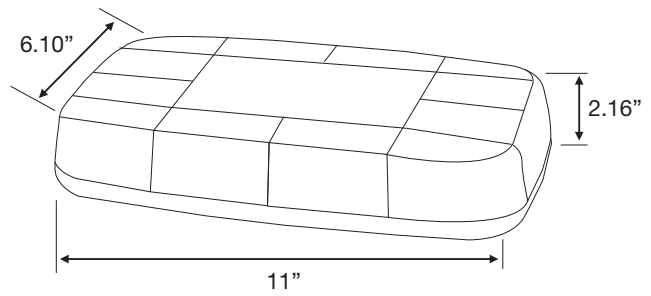

- Includes 15' cord

Part No.	Size	LEDs	Color	Amp	Mount	Power	Flash Patterns	Wt. (lbs.)	Cat.
8891040	11"L x 6.5"W x 2.25"H	24	Amber	2	Magnetic or Permanent	DC Adapter	10	3.5	889 (N)
8891042	11"L x 6.5"W x 2.25"H	24	Amber/Clear	2	Magnetic or Permanent	DC Adapter	10	3.5	889 (N)
8891044	11"L x 6.5"W x 2.25"H	24	Blue	2	Magnetic or Permanent	DC Adapter	10	3.5	889 (N)
NEW 8891048	11"L x 6.5"W x 2.25"H	24	Green	2	Magnetic or Permanent	DC Adapter	10	3.5	889 (N)
8891049	11"L x 6.5"W x 2.25"H	24	Amber/Green	2	Magnetic or Permanent	DC Adapter	10	3.5	889 (N)

Rectangular Mini Lightbar

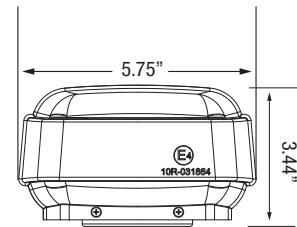
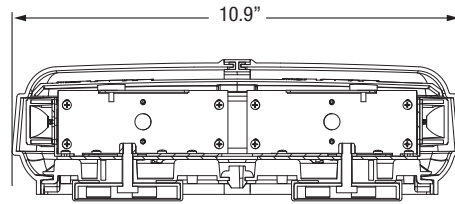

- Includes 15' cord

Part No.	Size	LEDs	Color	Amp	Mount	Power	Flash Patterns	Wt. (lbs.)	Cat.
8891050	10.93"L x 5.75"W x 3.44"H	24	Amber	3.5	Magnetic	DC Adapter	Random	4.0	889 (N)
8891052	10.93"L x 5.75"W x 3.44"H	24	Amber/Clear	3.5	Magnetic	DC Adapter	Random	4.0	889 (N)

LED Mini Lightbars

Hexagonal Mini Lightbar



- Includes 15' cord

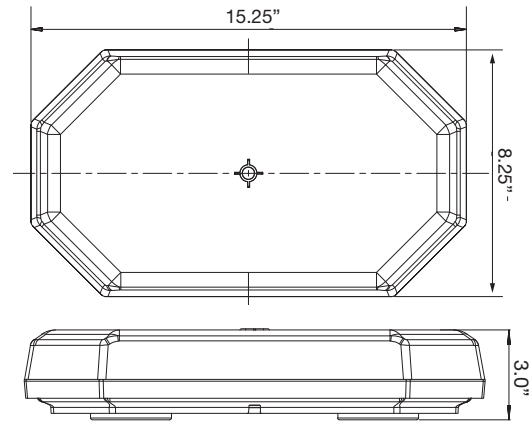

Permanent mounting studs and magnetic mounts studs



Part No.	Size	LEDs	Color	Amp	Mount	Power	Flash Patterns	Wt. (lbs.)	Cat.
8891060	15" L x 8.25"W x 3" H	56	Amber	3.2	Magnetic or Permanent	DC Adapter	10	5.5	889 (N)
8891062*	15" L x 8.25"W x 3" H	56	Amber/Clear	3.2	Magnetic or Permanent	DC Adapter	10	5.5	889 (N)
8891063*	15" L x 8.25"W x 3" H	56	Red	3.2	Magnetic or Permanent	DC Adapter	10	5.5	889 (N)

*8891062/8891063 are not SAE J595 Class 1

Oval Mini Lightbar

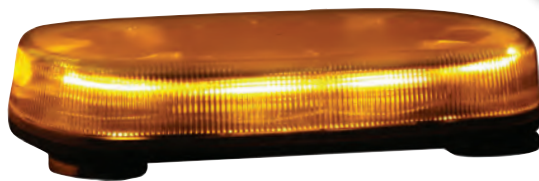
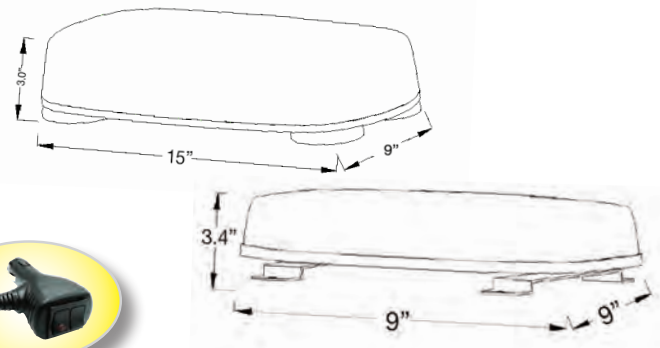

- Includes 15' cord

Part No.	Size	LEDs	Color	Amp	Mount	Power	Flash Patterns	Wt. (lbs.)	Cat.
8891070	15"L x 9"W x 3.0" H	32	Amber	3.2	Magnetic	DC Adapter	24	5.0	889 (N)
8891071	15"L x 9"W x 3.4" H	32	Amber	3.2	Permanent	DC Adapter	24	4.7	889 (N)

Oval Mini Lightbar



Permanent mounting and magnetic mounts studs

- Includes 15' cord

Part No.	Size	LEDs	Color	Amp	Mount	Power	Flash Patterns	Wt. (lbs.)	Cat.
8891080	9.88"L x 6.69" W x 1.61" H	40	Amber	3.34	Magnetic/Permanent	DC Adapter	20	3.10	889 (N)
8891082*	9.88"L x 6.69" W x 1.61" H	40	Amber/Clear	3.34	Magnetic/Permanent	DC Adapter	20	3.10	889 (N)

*8891082 is not SAE J595 Class 1

Rectangular Mini Lightbar



- Includes 15' cord

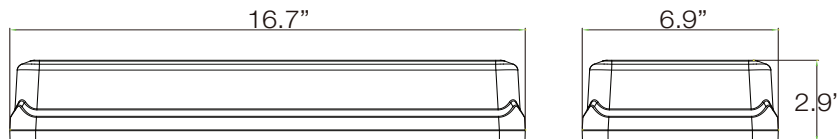
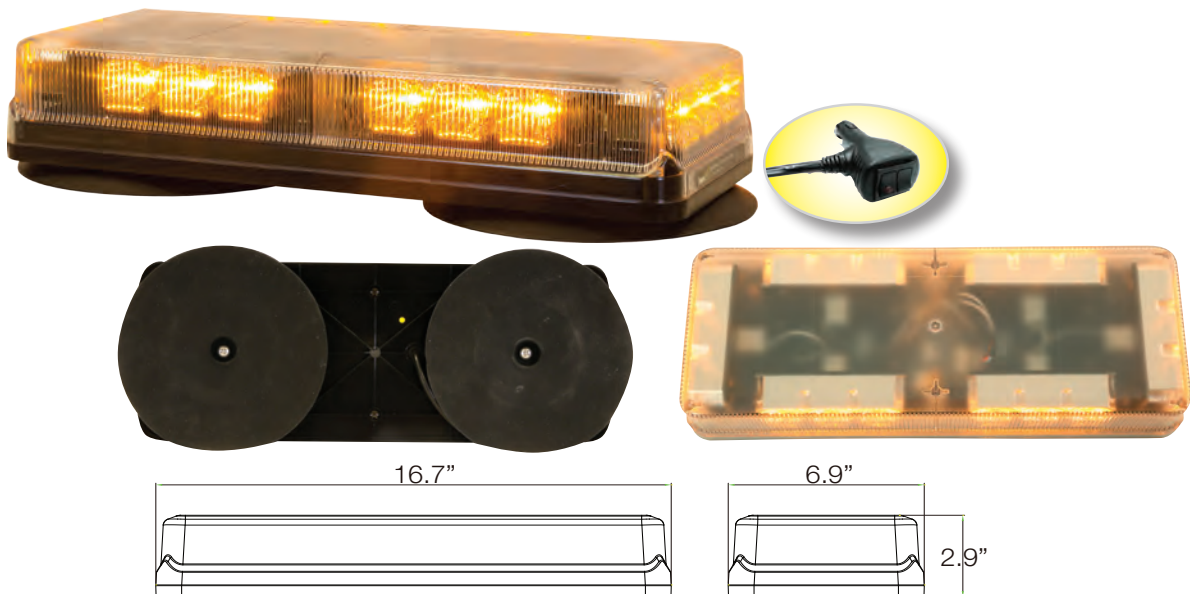

Part No.	Size	LEDs	Color	Amp	Mount	Power	Flash Patterns	Wt. (lbs.)	Cat.	
8891090	16.7"L x 6.9"W x 2.9"H	18	Amber	3.2	Vacuum-Magnetic	DC Adapter	19 Patterns	7.78	889 (N)	
8891091	Permanent Bolt-on Aluminum Mounts Only								1.70	889 (N)

LED Mini Lightbars and Accessories

Hexagonal Mini Lightbar

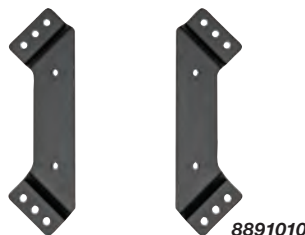
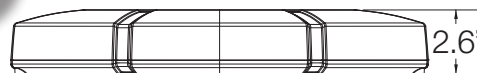
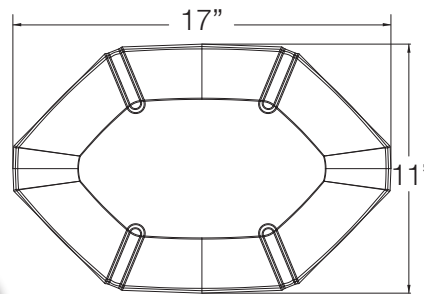

- Includes 15' cord

Part No.	Size	LEDs	Color	Amp	Mount	Power	Flash Patterns	Wt. (lbs.)	Cat.
8891100	16.75"L x 11"W x 2.75"H	30	Amber	3.6	Vacuum-Magnetic	DC Adapter	25	9.9	889 (N)
8891102*	16.75"L x 11"W x 2.75"H	30	Amber/Clear	3.6	Vacuum-Magnetic	DC Adapter	25	9.9	889 (N)
8891010	Permanent Bolt-On Aluminum Mounts							0.70	889 (N)

* 8891102 is not SAE J595 Class 1

Drill-Free Light Bar Cab Mounts

- Ideal for aluminum cabs
- Mounts in 3rd brake light OEM location
- Powder-coated aluminum platform
- 30 lb. capacity
- 22"L x 10"W x 1-1/2"H



shown with optional lightbar **8891060** (not included)

Note: Third brake light not included, OEM light transfers

Part No.	Description	Wt. (lbs.)	Cat.
8895095	For Chevy-GMC 1500-3500 Cab & Chassis 2007-2013	7.25	889 (N)
8895100	For Chevy-GMC 1500-3500 Pickup & Chassis 2014-2016	7.25	889 (N)
8895105	Colorado/Canyon with/base "103" antenna	7.25	889 (N)
8895110	Colorado/Canyon with/Onstar antenna	7.25	889 (N)
8895150	For F-150, 2015+ and F-250/550, 2017 with aluminum cabs	7.25	889 (N)
8895250	Light Bar Mount For F-250/550 Steel cab pickup and chassis 2006-2016	7.25	889 (N)
8895300	For Ram-Dodge 1500-3500 Pickup & Chassis 2010-2016	7.25	889 (N)
8895350	For 5500 Cab Chassis Ram-Dodge 2010-2016	7.25	889 (N)

NEW

LED Dual Function Directional-Warning Lights



Part No.	Size	LEDs	Color	Amp	Power	Flash	Cable	Wt. (lbs.)	Cat.	
8894037	36.7"L x 2.25"W x 1.81"H	24	Amber	3.2	12-24 VDC	22 Flash Patterns; 11 Strobe/11 Traffic	25'	6.6	889 (N)	
8894047	46.5"L x 2.25"W x 1.81"H	32	Amber	3.2	12-24 VDC	22 Flash Patterns; 11 Strobe/11 Traffic	25'	7.5	889 (N)	
8894050	Optional L-Bracket Riser Mounts - 4.3" H								0.5	889 (N)
6391204	Switch Panel, (3) On/Off, (1) Momentary								0.27	639 (N)
6391207*	Switch Panel, (4) On/Off, (2) Momentary								0.39	639 (N)

* Also works with 6391208 and 6391209 shown on pg C38

LED Dashboard Lightbar



Part No.	Size	LEDs	Color	Amp	Mount	Power	Flash Patterns	Wt. (lbs.)	Cat.
8891024	14" L x 3.25 W x 2.5" H	12	Amber	0.35	Suction/Multiple	DC Adapter	19	1.58	889 (N)
8891025	14" L x 3.25 W x 2.5" H	12	Amber/Clear	0.35	Suction/Multiple	DC Adapter	19	1.58	889 (N)

4" Round Rechargeable Magnetic Road Strobe/Flare



Part No.	Size	LEDs	Color	Amp	Flash	Wt. (lbs.)	Cat.
8891016	4"	16	Amber	0.50	9 Patterns	0.85	889 (N)
8891018	4"	16	Amber	0.50	Case includes (6) LED road flares, 12 volt and 110 volt charging connections. Storage doubles as a charging base.	6.42	889 (N)

LED Modular Lightbars

LED Modular Lightbars



- Standard with amber strobes.
- Customize by adding amber, blue, clear and/or red strobes
- Middle strobes have 3-LED reflector heads
- Corner strobes have 6-LED D-fuser heads
- Dimming mode
- Extruded aluminum frame
- Optional work lights and take down lights on 49", 54" & 60" Models
- Mounting feet and controller optional
- 54" also available - call for quote



24" LED Modular Lightbar

- 8 strobe modules standard
- 24 flash patterns

A = Amber Strobe
C = Clear Strobe

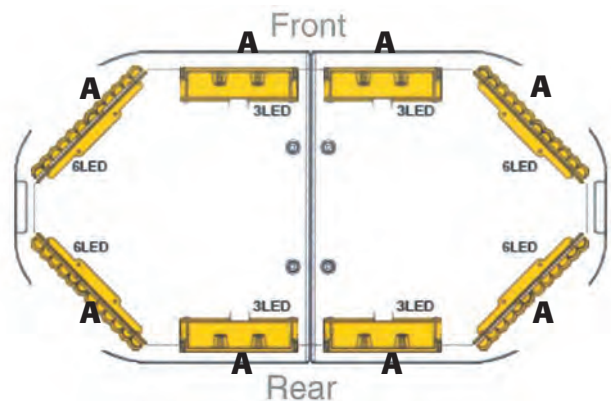

Part No.	Size	LEDs	Amp	MODULES DESCRIPTION	Wt. (lbs.)	Cat.
8893024	24"	36	3-6	6 Amber	15.4	889 (N)
88930243	24"	36	3-6	6 Amber/Clear	15.4	889 (N)

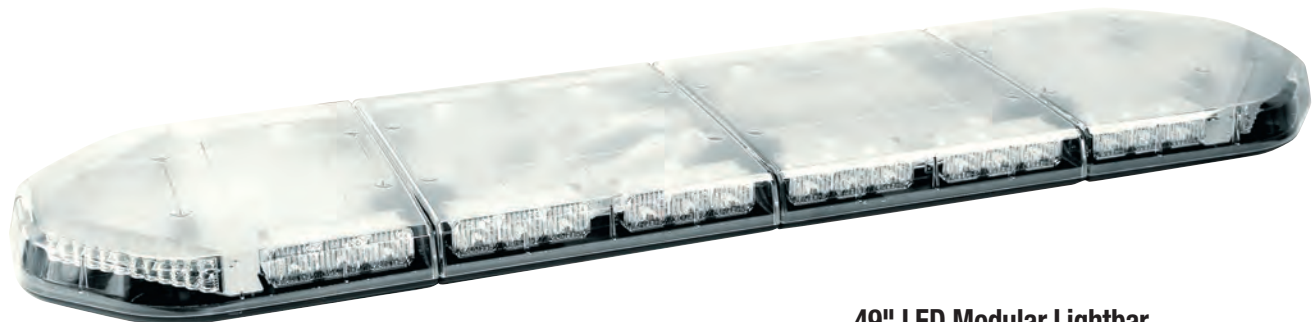

Mounting feet and controller sold separately
See page 38-39

49" LED Modular Lightbar

- 8-14 strobe modules
- 11 flash patterns, 5 programmable groups
- A total of 55 different flash sequences
- 5 strobe head groupings

Part No.	Size	LEDs	Amp	MODULES DESCRIPTION	Wt. (lbs.)	Cat.
8893049	49"	54	7-14	14 Amber Built-in traffic arrow	33.0	889 (N)
88930492	49"	36	7-14	8 Amber	31.8	889 (N)
88930493	49"	36	7-14	8 Amber/Clear	31.8	889 (N)

8893049

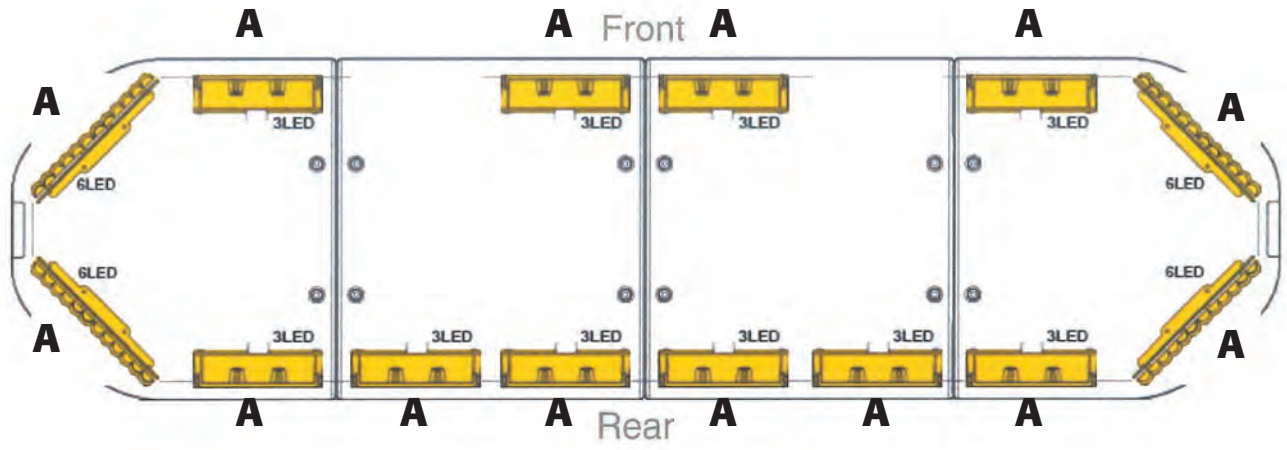

88930492

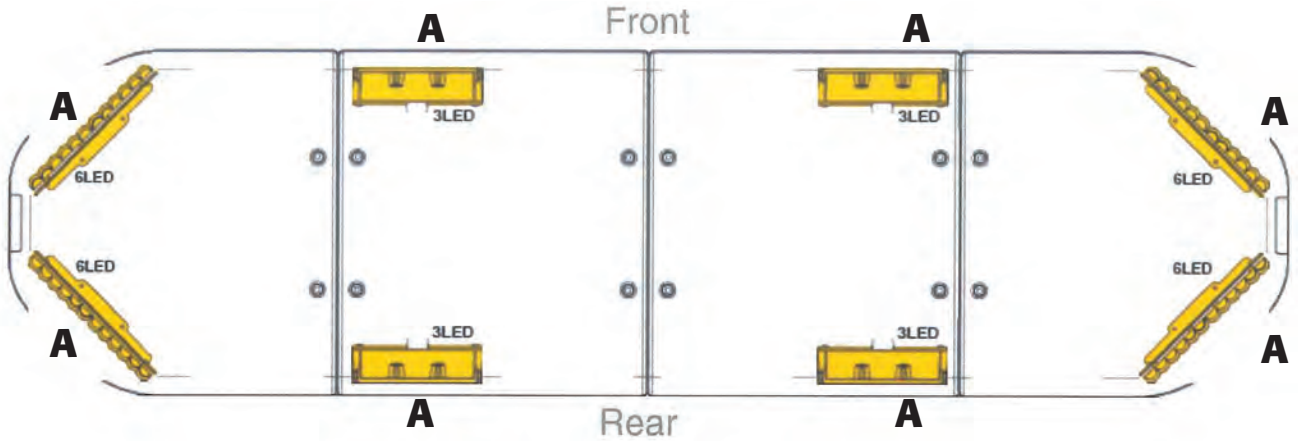

88930493

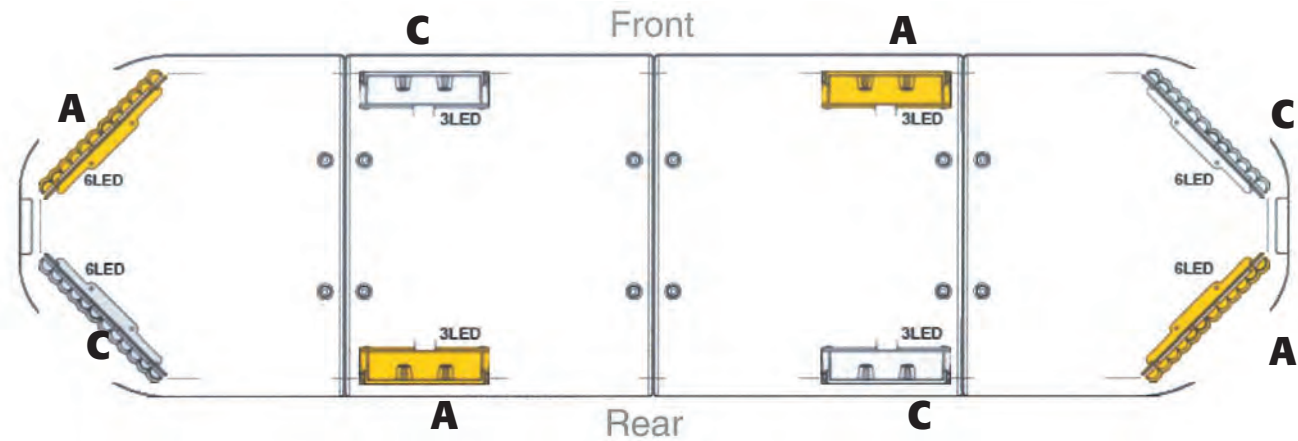

LED Modular Lightbars

LED Modular Lightbars



- Standard with amber strobes.
- Customize by adding amber, blue, clear or red strobes
- Middle strobes have 3-LED reflector heads
- Corner strobes have 6-LED D-fuser heads
- Dimming Mode
- Extruded Aluminum Frame



60" LED Modular Lightbar

- 8-20 strobe modules and Stop/turn/tail light modules available
- 11 flash patterns, 5 programmable groups
- A total of 55 different flash sequences
- 5 strobe head groupings

A = Amber Strobe
C = Clear Strobe
STT = Red, Stop-Turn-Tail*

*Stop, turn, tail lights can be replaced with strobes by request

*Mounting Feet & controllers sold separately: see page 38-39

Part No.	Size	LEDs	Amp	MODULES DESCRIPTION	Wt. (lbs.)	Cat.
8893060	60"	60	8-16	14 Amber, 2 Red LED stop-turn-tail lights Built-in traffic arrow	36.1	889 (N)
88930603	60"	42	8-16	8 Amber, 2 Red LED stop-turn-tail lights 2 LED take down lights	34.7	889 (N)
88930604	60"	48	8-16	12 Amber	34.9	889 (N)
88930605	60"	60	8-16	16 Amber, Built-in Traffic Arrow	36.1	889 (N)

8893060

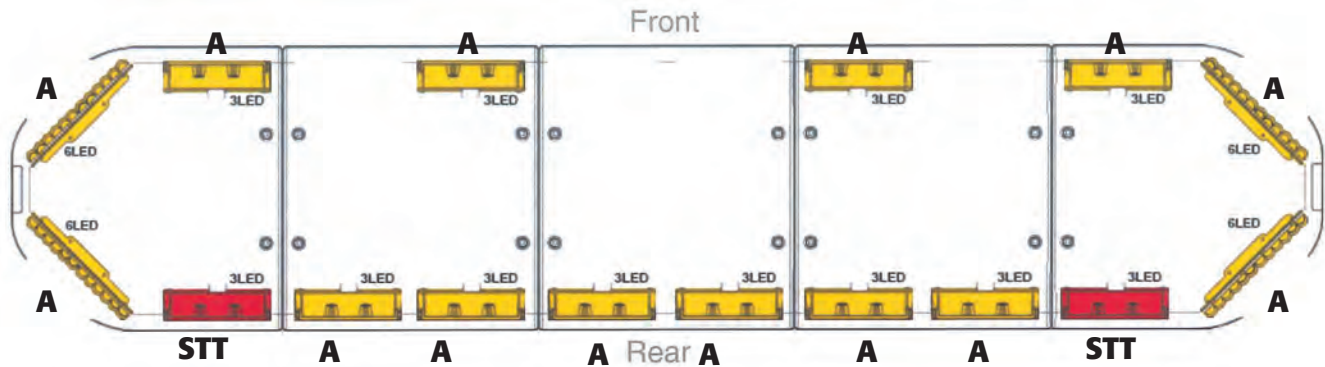

3-LED Middle Strobe Reflector



Part No.	LEDs	Color	Wt. (lbs.)	Cat.
3024631	3	Amber	0.28	889 (N)
3024632	3	Clear	0.27	889 (N)
3024633	3	Red	0.28	889 (N)
3024634	3	Blue	0.27	889 (N)
NEW 3032932*	3	Green	0.28	889 (N)

* 3032932 is not CA13 or SAE J595 Class 1

6 LED Corner Strobe D-Fuser



Part No.	LEDs	Color	Wt. (lbs.)	Cat.
3024635	6	Amber	0.21	889 (N)
3024636	6	Clear	0.20	889 (N)
3024637	6	Red	0.21	889 (N)
3024638	6	Blue	0.21	889 (N)
NEW 3032933	6	Green	0.21	889 (N)

6 LED Middle Take Down



Part No.	LEDs	Color	Wt. (lbs.)	Cat.
3024639	6	Clear	0.23	889 (N)
NEW 3024640	9	Clear	0.23	889 (N)

Cab Mount, Adjustable Width Plastic Brackets



Part No.	Size	Wt. (lbs.)	Cat.
3024646	12.625"L x 5.50" W x 2.25" T	2.58	889 (N)

* Use with Stainless Steel Strap Kits

Stainless Steel Strap Kits (for use w/Cab Mounts)



Part No.	Description	Wt. (lbs.)	Cat.
3025442	GM1500/2500/3500/4500/5500 for 49", 54" and 60" Lightbars	1.53	889 (N)
3026114	F-150, 2004-2014, 49", 54" & 60" LIGHTBARS	1.60	889 (N)
3034400	F-150 2015+, 49", 54" & 60" LIGHTBARS	1.60	889 (N)
3026115	F-250/350/450/550, 1999-2016, 49", 54" & 60" LIGHTBARS	1.60	889 (N)
3026116	RAM 500/2500/3500/4500/5500, 2009-2016, for 49", 54" and 60" Lightbars	1.60	889 (N)

Cab Mount, Adjustable Width Steel Brackets



Part No.	Size	Wt. (lbs.)	Cat.
3024647	10.125"L x 6.5"W x 2-3" T	3.89	889 (N)

* Use with Stainless Steel Strap Kits

LED Modular Lightbar Accessories

Headache Rack, Narrow Surface Steel Brackets



Part No.	Description	Wt. (lbs.)	Cat.
3024648	4.5"L x 6.75"W x 1.75"T	3.16	889 (N)

Wide Surface Steel Brackets



Part No.	Description	Wt. (lbs.)	Cat.
3024649	8.75"L x 2.50"W x 2.25"T	2.47	889 (N)

4 Switch Panel, Pre-Wired

- For use with 49", 54" & 60" modular lightbars
- 3.75"L x 1.25"W x 1.5"T
- Built-In Arrow Stick Controls



Part No.	Description	Wt. (lbs.)	Cat.
6391204	4-Switch Panel, Pre-Wired	0.27	639 (N)

5 Switch Panel, Pre-Wired

- For use with 24", 49", 54" & 60" modular lightbars, plus surface and recessed mounted strobes
- 3.5"L x 1.0"W x 2.5"T



Part No.	Description	Wt. (lbs.)	Cat.
6391205	5-Switch Panel, Pre-Wired	0.35	639 (N)

6, 7 or 8 Switch Panel, Pre-Wired w/LED Pattern Display

- For use with 49", 54" and 60" modular lightbars
- Programmable
- Built-In Arrow Stick Controls



6391206



6391208



6391209

Part No.	Description	Wt. (lbs.)	Cat.
6391206	6-Switch Panel, Pre-Wired w/LED Pattern Display	0.39	639 (N)
6391208	Switch Panel, 7 Function, Multi-Purpose, Programmable	0.83	639 (N)
6391209	Switch Panel, 8 Function, Multi-Purpose, Programmable, w/Relays	0.83	639 (N)

NEW

24 LED Portable Amber Beacon



- Requires 2 D-size batteries
- Automatic On/Off operation w/light sensor or manual operation via selector switch
- Push button override

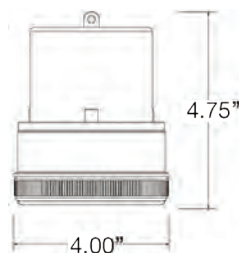

Part No.	Size	Color	Power	Mount	Cord	Wt. (lbs.)	Cat.
NEW SL475A	4" Diam x 4.75" T	Amber	2-D Batteries	Magnets	N/A	0.73	889 (N)
SL475R	4" Diam x 4.75" T	Red	2-D Batteries	Magnets	N/A	0.73	889 (N)
Part No.	Description					Wt. (lbs.)	Cat.
NEW 3029961	Galvanized Mounting Bracket					1.25	889 (N)

40 LED Strobe Beacon

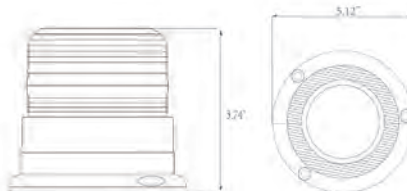

Part No.	Size	Color	Amp	Flash	Mount	Cord	Wt. (lbs.)	Cat.
NEW SL501A	5-1/8" Diam x 3-3/4"	Amber	0.6	2 Flash Patterns	Magnetic and Permanent	10'	1.28	889 (N)

6 LED Eight Flash Strobe

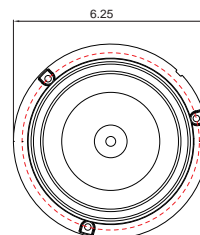
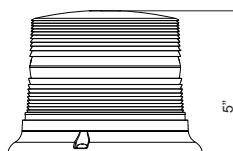

Part No.	Size	LEDs	Color	Amp	Flash	Mount	Cord	Wt. (lbs.)	Cat.
SL645ALP	6.25" Diam x 5" T	6	Amber	1.5	90 FPM/8-Flash	1" Pipe/3-Bolt Mount/Magnetic	10'	2.4	889 (N)
SL645CLP	6.25" Diam x 5" T	6	Clear	1.5	90 FPM/8-Flash	1" Pipe/3-Bolt Mount/Magnetic	10'	2.4	889 (N)
SL646ALP	6.25" Diam x 5" T	6	Amber	1.5	90 FPM/8-Flash	1" Pipe/3-Bolt Mount/Magnetic	9"	2.0	889 (N)

6 LED Eight Flash Strobe

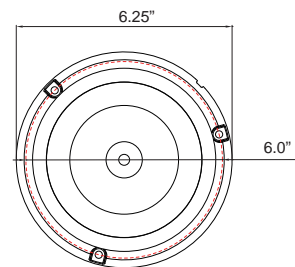
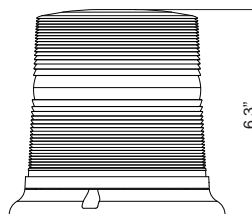

Part No.	Size	LEDs	Color	Amp	Flash	Mount	Cord	Wt. (lbs.)	Cat.
SL665A	6.25" Diam x 6.3" T	6	Amber	1.5	90 FPM/8-Flash	1" Pipe/3-Bolt Mount/Magnetic	10'	2.7	889 (N)

LED Beacon Strobe Lights

3 LED Eight Flash Strobe

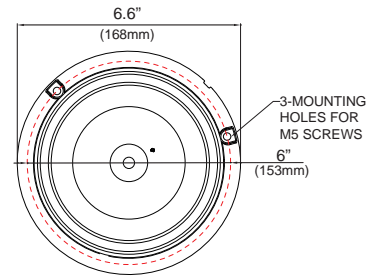
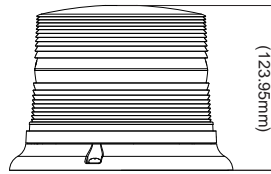

Part No.	Size	LEDs	Color	Amp	Flash	Mount	Cord	Wt. (lbs.)	Cat.
SL620ALP	6.25" Diam x 5" T	3	Amber	1.5		1" Pipe/3-Bolt Mount/Magnetic	10'	2.46	889 (N)

3 LED Eight Flash Strobe

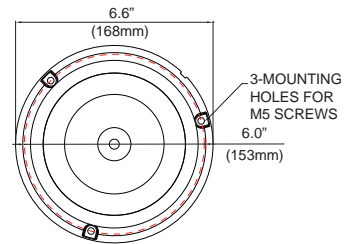
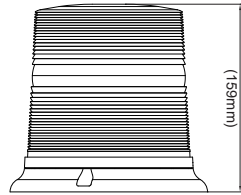

Part No.	Size	LEDs	Color	Amp	Flash	Mount	Cord	Wt. (lbs.)	Cat.
SL630A	6.25" Diam x 6.3" T	3	Amber	1.5		1" Pipe/3-Bolt Mount/Magnetic	10'	2.65	889 (N)

8 LED Programmable Flash Strobe

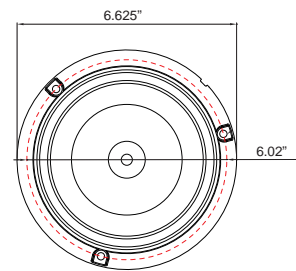
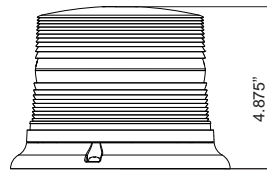

Part No.	Size	LEDs	Color	Amp	Flash	Mount	Cord	Wt. (lbs.)	Cat.
SL675ALP	6.625" Diam x 4.875" T	8	Amber	1.5	15 Flash Patterns	Magnetic	10'	2.65	889 (N)
SL685ALP	6.625" Diam x 4.875" T	8	Amber	1.5	15 Flash Patterns	1" Pipe/3-Bolt Mount	9"	1.63	889 (N)

12 LED Programmable Flash Strobe

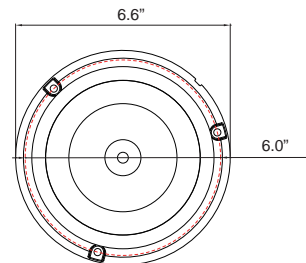
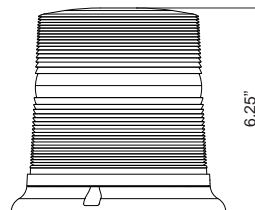

Part No.	Size	LEDs	Color	Amp	Flash	Mount	Cord	Wt. (lbs.)	Cat.
SL695A	6.25" Diam x 6.625" T	12	Amber	2.7	12 Flash Patterns	Magnetic	10'	2.67	889 (N)
SL696A*	6.25" Diam x 6.625" T	12	Amber	2.7	12 Flash Patterns	1" Pipe/3-Bolt Mount	12"	1.95	889 (N)

Smooth clear outer lens meets CA13 requirements
 *SL696A has the Blunt Cut Ends, not accessory plug

Utility Strobe

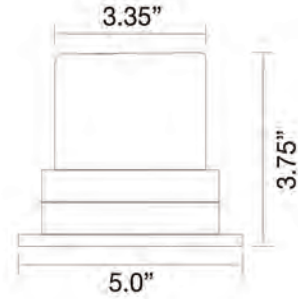

Part No.	Size	Joules	Color	Amp	Flash	Mount	Cord	Wt. (lbs.)	Cat.
SL500A	5-1/8" Diam x 3-3/4"	1.7	Amber	0.6	2 Flash Patterns	Magnetic and Permanent	10'	1.13	889 (N)

Compact Strobe

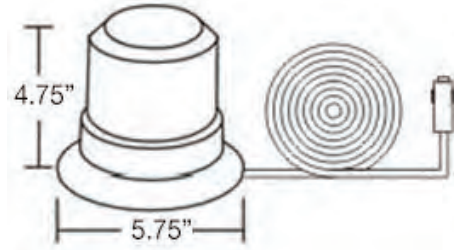

Part No.	Size	Joules	Color	Amp	Flash	Mount	Cord	Wt. (lbs.)	Cat.
SL650A	6" Diam x 4.75" T	1.7	Amber	0.3	90 FPM/10-Flash	1" Pipe/3-Bolt Mount	10'	1.5	889 (N)

Quad Flash Strobe

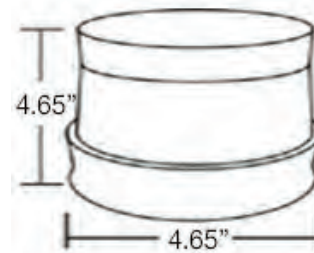

Part No.	Size	Joules	Color	Amp	Flash	Mount	Cord	Wt. (lbs.)	Cat.
B745229T	5.25" Diam x 4" T	3.8	Amber	0.75	Quad	1" Pipe/3-Bolt Mount	10'	2.58	889 (N)
B745236T	5.25" Diam x 4" T	3.8	Amber	0.75	Quad	Magnetic	10'	1.75	889 (N)
211141	Replacement Flash Tube							0.2	889 (N)

Incandescent Dual Flash Strobe

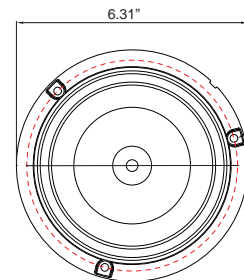
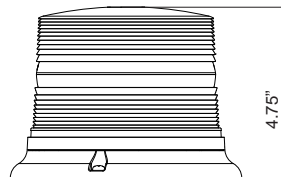

Part No.	Size	Joules	Color	Amp	Flash	Mount	Cord	Wt. (lbs.)	Cat.
SL640ALP	6.31" Diam x 4.75" T	8	Amber	1.5	Dual Flash 80 FPM	1" Pipe/3-Bolt Mount	10"	1.75	889 (N)
3016342	Replacement Bulb							0.2	889 (N)

Incandescent and Halogen Beacon Strobe Lights

Incandescent Dual Flash Strobe

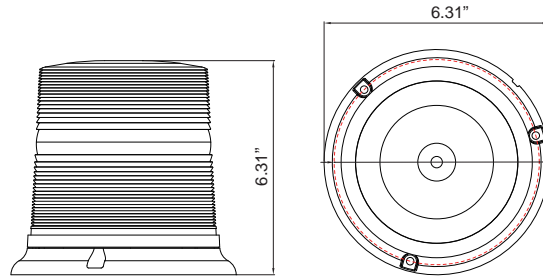

Part No.	Size	Joules	Color	Amp	Flash	Mount	Cord	Wt. (lbs.)	Cat.
SL660A	6.31" Diam x 6.31" T	8	Amber	1.5	Dual Flash 80 FPM	1" Pipe/3-Bolt Mount	10"	2.0	889 (N)
3016342	Replacement Bulb							.02	889 (N)

12V Incandescent Teardrop Revolving Light

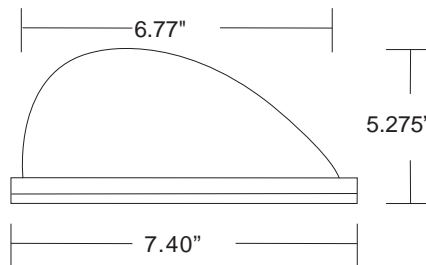

Part No.	Size	Color	Amp	Flash	Mount	Cord	Wt. (lbs.)	Cat.
RL650A	7" Diam x 5.25" T	Amber	1.5	90 FPM	Magnetic	10'	1.5	889 (N)

Halogen Mini Lightbar

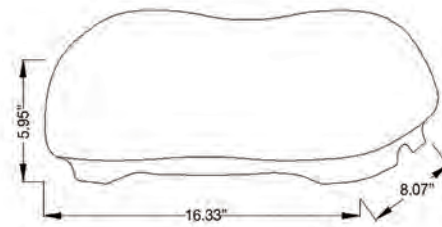

Part No.	Size	Color	Amp	Flash	Mount	Cord	Wt. (lbs.)	Cat.
8891020	16.5" L x 8"W x 6"T	Amber	7	320 FPM	Magnetic	10'	5.0	889 (N)

Mounting Brackets



B210880



8891001



8891002

Part No.	Size	Description	Wt. (lbs.)	Cat.
B210880	9" W (ID) x 7.625" T (OD)	Self leveling. Mounting Bracket, 3/16" Steel plate with black powder coating.	6.7	889 (N)
8891001	6.625" Diam x 4.875" T	Beacon Mirror Mounting Bracket, Stainless Steel, Adjustable. Includes U-Bolts. Bolt Pattern Fits Most Beacons up to 6.625" diameter.	1.4	889 (N)
8891002	6.5" Diam x 6.5" T	Black Beacon Brush Guard. (See fit guide online at buyersproducts.com)	1.0	889 (N)

5" LED Sealed Rubber Flood Light

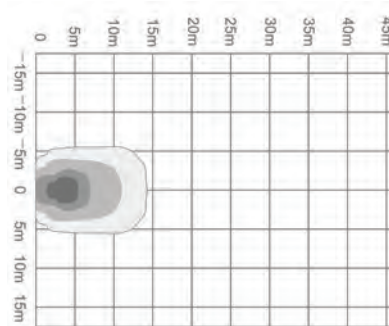
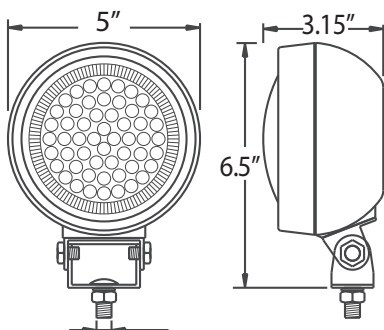

Part No.	Size	LED's	Amps	Lumens	Color	Base / Mount	Lead Length	Connection	Wt. (lbs.)	Cat.
1492110	5"	54	3	375	Clear	8mm stud SST	36"	Blunt Cut	1.63	562 (N)

5" LED Sealed Rubber Flood Light

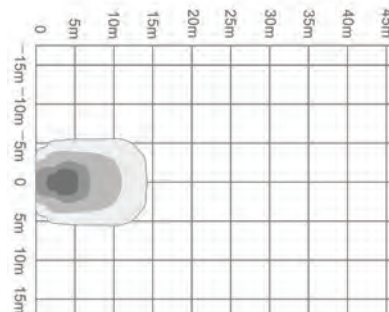
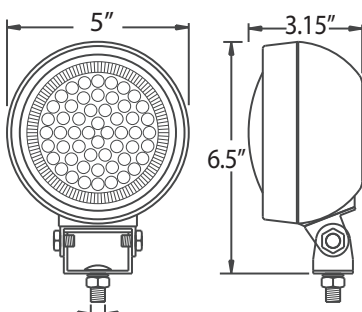

Part No.	Size	LED's	Amps	Lumens	Color	Base / Mount	Lead Length	Connection	Wt. (lbs.)	Cat.
1492111	5"	54	3	375	Amber	8mm stud SST	36"	Blunt Cut	1.63	562 (N)

5" LED Sealed Rubber Flood Light

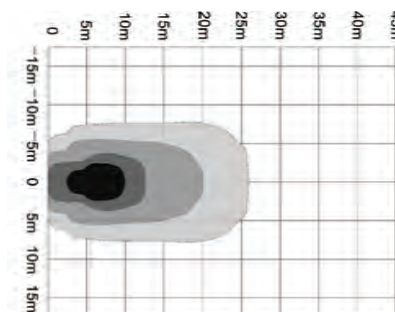
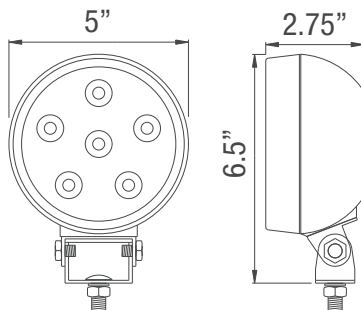

Part No.	Size	LED's	Amps	Lumens	Color	Base / Mount	Lead Length	Connection	Wt. (lbs.)	Cat.
1492112	5"	6	1.5	1350	Clear	8mm stud SST	36"	Blunt Cut	1.80	562 (N)

5.5" LED Flood Light

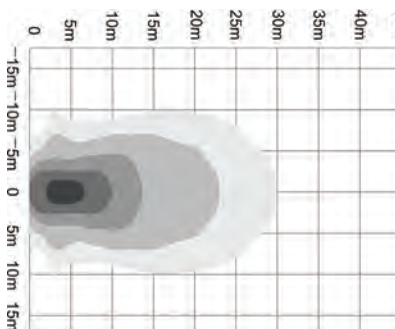
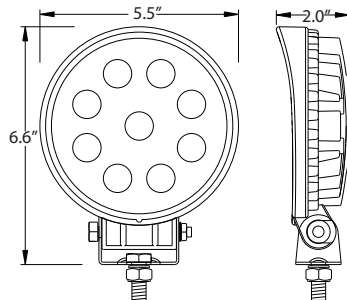

Part No.	Size	LED's	Amps	Lumens	Color	Base / Mount	Lead Length	Connection	Wt. (lbs.)	Cat.
1492114	5.5"	9	1.5	1500	Clear	8mm stud SST	36"	Blunt Cut	1.58	562 (N)

LED Flood and Spot Lights

4.6" LED Flood Light

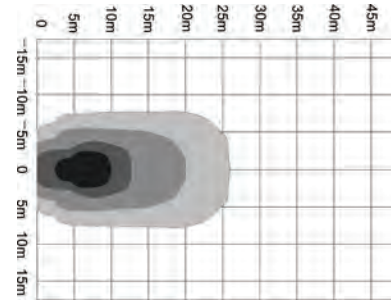
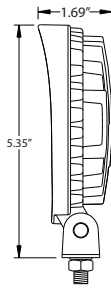
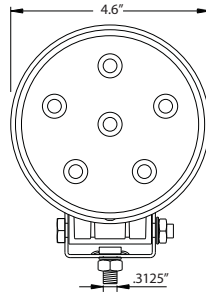

Part No.	Size	LED's	Amps	Lumens	Color	Base / Mount	Lead Length	Connection	Wt. (lbs.)	Cat.
1492115	4.6"	6	1.5	1350	Clear	8mm stud SST	36"	Blunt Cut	1.20	562 (N)

4.6" LED Flood Light

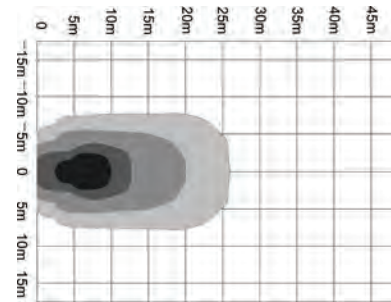
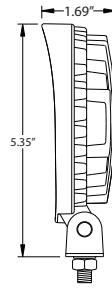
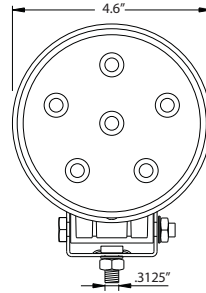

Part No.	Size	LED's	Amps	Lumens	Color	Base / Mount	Lead Length	Connection	Wt. (lbs.)	Cat.
1492116	4.6"	6	1.5	1350	Amber	8mm stud SST	36"	Blunt Cut	1.20	562 (N)

4.6" LED Flood Light

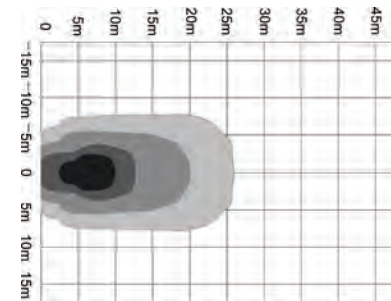
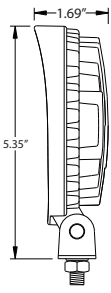
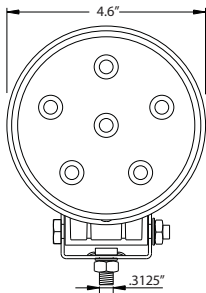

Part No.	Size	LED's	Amps	Lumens	Color	Base / Mount	Lead Length	Connection	Wt. (lbs.)	Cat.
1492130	4.6"	6	1.5	1350	Clear	Magnetic	30'	12V DC Adapter	2.50	562 (N)

4.6" LED Spot Light

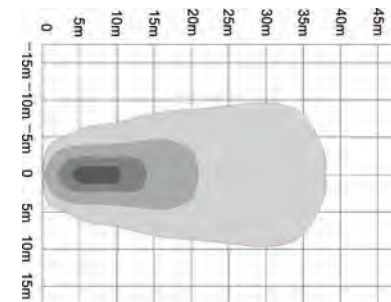
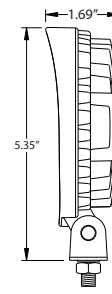
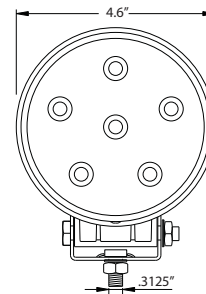

Part No.	Size	LED's	Amps	Lumens	Color	Base / Mount	Lead Length	Connection	Wt. (lbs.)	Cat.
1492215	4.6"	6	1.5	1350	Clear	8mm stud SST	36"	Blunt Cut	1.20	562 (N)

4.6" Flood Light with White Housing

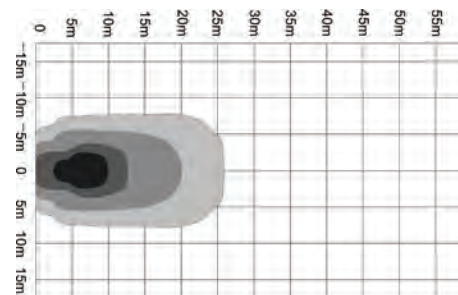
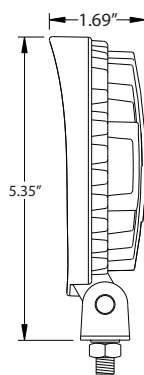
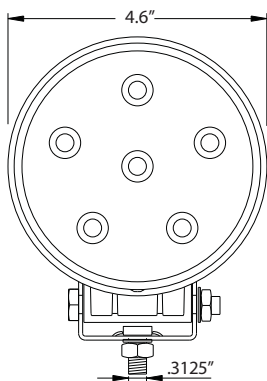

Part No.	Size	LED's	Amps	Lumens	Color	Base / Mount	Lead Length	Connection	Wt. (lbs.)	Cat.
1493215	4.6"	6	1.5	1350	Clear	SST	36"	Blunt Cut	1.20	562 (N)

5" LED Flood Light

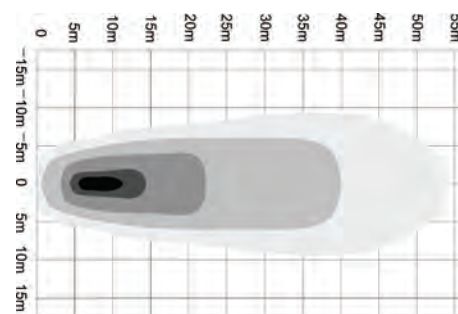
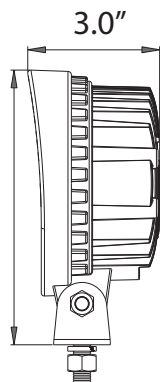
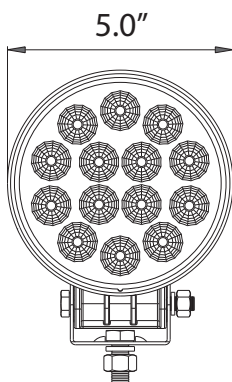

Part No.	Size	LED's	Amps	Lumens	Color	Base / Mount	Lead Length	Connection	Wt. (lbs.)	Cat.
1492127	5"	14	3	2525	Clear	SST	36"	Blunt Cut	1.20	562 (N)

5.75" LED Oval Flood-Spot Light

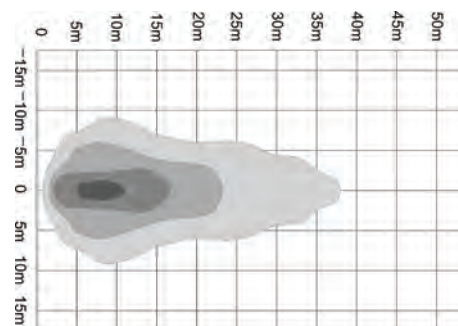
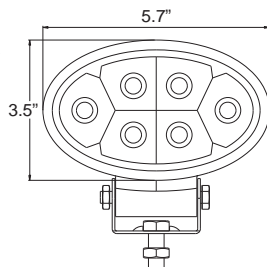

Part No.	Size	LED's	Amps	Lumens	Color	Base / Mount	Lead Length	Connection	Wt. (lbs.)	Cat.
1492113	5.75"	6	1.5	1350	Clear	SST	36"	Blunt Cut	1.20	562 (N)

LED Flood and Spot Lights

LED Pedestal Mount Adjustable Flood Light with Built-in Switch

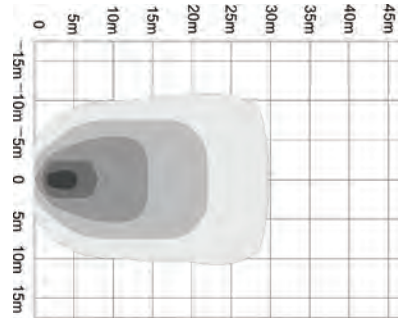
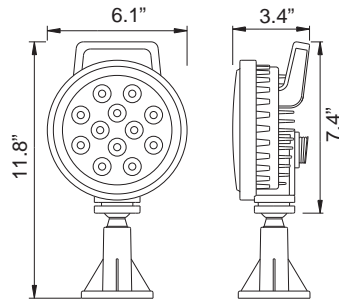

Part No.	Size	LED's	Amps	Lumens	Color	Base / Mount	Lead Length	Connection	Wt. (lbs.)	Cat.
1492120	6"	12	3	1350	Clear	Pedestal/Bolt	36"	Blunt Cut	2.25	562 (N)

LED Pedestal Mount Adjustable Spot Light with Built-in Switch

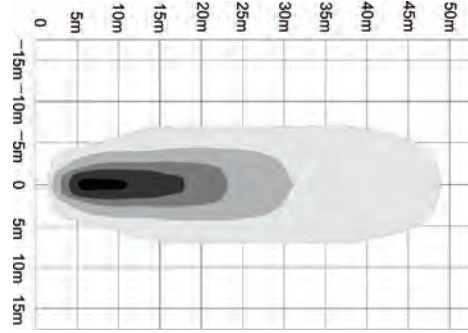
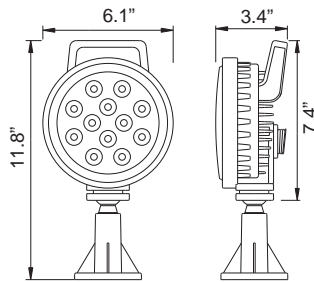

Part No.	Size	LED's	Amps	Lumens	Color	Base / Mount	Lead Length	Connection	Wt. (lbs.)	Cat.
1492121	6"	12	3	1350	Clear	Pedestal/Bolt	36"	Blunt Cut	2.25	562 (N)

Features 360 degree rotation

LED Articulating Flood Light with Built-in Switch

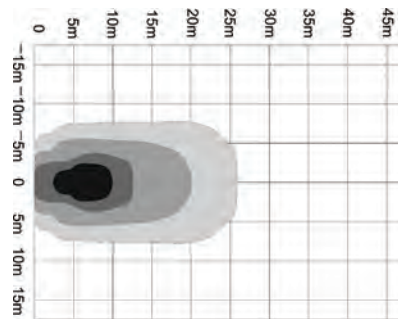
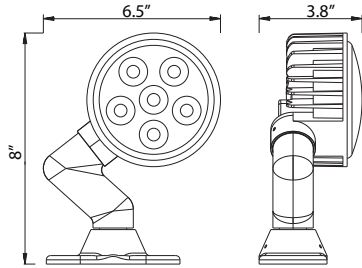

Part No.	Size	LED's	Amps	Lumens	Color	Base / Mount	Lead Length	Connection	Wt. (lbs.)	Cat.
1492125	5"	6	1.5	1350	Clear	Pedestal/Bolt	36"	Blunt Cut	2.33	562 (N)

LED Articulating Spot Light with Built-in Switch

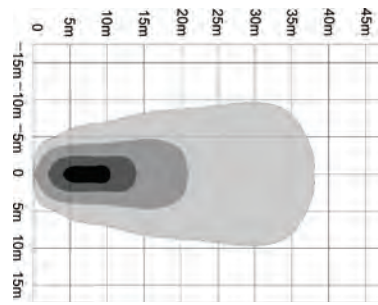
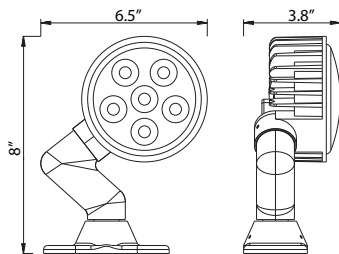

Part No.	Size	LED's	Amps	Lumens	Color	Base / Mount	Lead Length	Connection	Wt. (lbs.)	Cat.
1492126	5"	6	1.5	1350	Clear	Adjustable/Bolt	36"	Blunt Cut	2.41	562 (N)

4.3" Square LED Flood Light

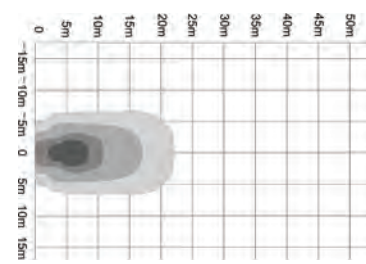
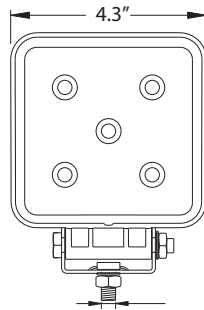

Part No.	Size	LED's	Amps	Lumens	Color	Base / Mount	Lead Length	Connection	Wt. (lbs.)	Cat.
1492117	4.3"	5	1.2	1050	Clear	SST	36"	Blunt Cut	1.20	562 (N)

5.3" Square LED Flood Light

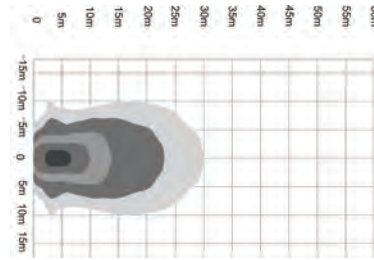
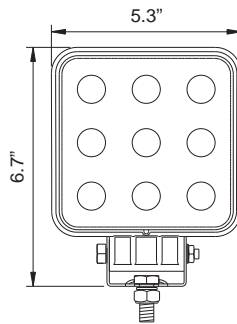

Part No.	Size	LED's	Amps	Lumens	Color	Base / Mount	Lead Length	Connection	Wt. (lbs.)	Cat.
1492119	5.3"	9	2.25	1500	Clear	SST	36"	Blunt Cut	1.76	562 (N)

3.9" Square LED Flood Light

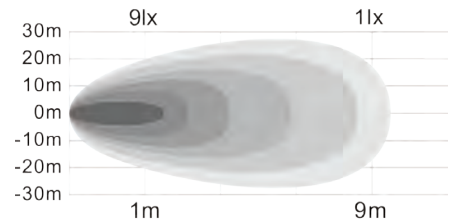
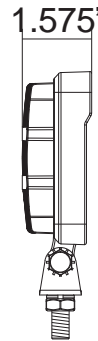
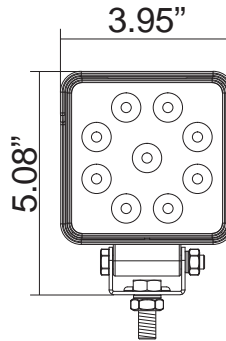

Part No.	Size	LED's	Amps	Lumens	Color	Base / Mount	Lead Length	Connection	Wt. (lbs.)	Cat.
NEW 1492134	3.95"	9	1.25	2430	Clear	SST	36"	Blunt Cut	1.12	562 (N)

4.6" Square LED Flood Light

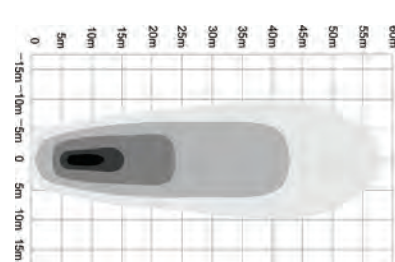
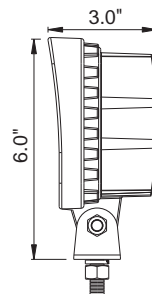
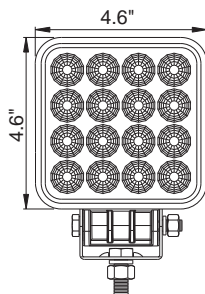

Part No.	Size	LED's	Amps	Lumens	Color	Base / Mount	Lead Length	Connection	Wt. (lbs.)	Cat.
1492128	4.6"	16	3.8	3120	Clear	SST	36"	Blunt Cut	2.25	562 (N)

LED Flood and Spot Lights

2.6" Square LED Flood Light

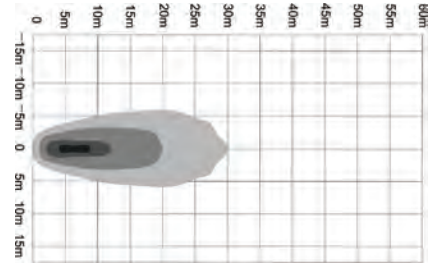
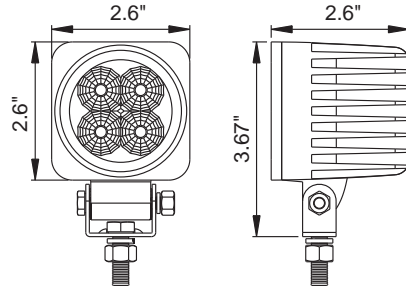

Part No.	Size	LED's	Amps	Lumens	Color	Base / Mount	Lead Length	Connection	Wt. (lbs.)	Cat.
1492129	2.6"	4	1.0	780	Clear	SST	36"	Blunt Cut	1.0	562 (N)

2.8" Square LED Flood Light

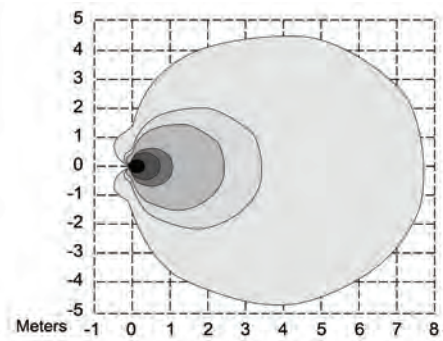
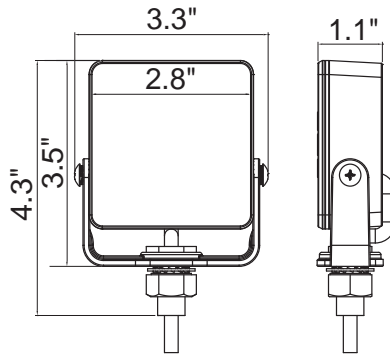

Part No.	Size	LED's	Amps	Lumens	Color	Base / Mount	Lead Length	Connection	Wt. (lbs.)	Cat.
1492136	2.8"	4	0.6	400	Clear	12 mm stud	36"	Blunt Cut	0.65	562 (N)

3.23" Square LED Flood Light

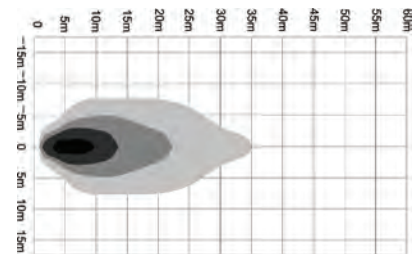
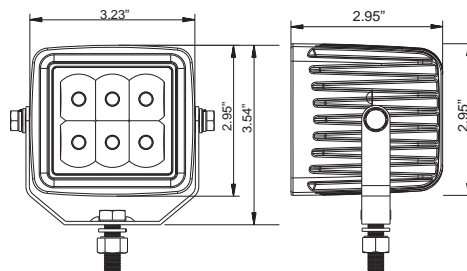

Part No.	Size	LED's	Amps	Lumens	Color	Base / Mount	Lead Length	Connection	Wt. (lbs.)	Cat.
1492137	3.23"	6	1.5	1380	Clear	SST	36"	Blunt Cut	1.5	562 (N)

3.23" Square LED Spot Light

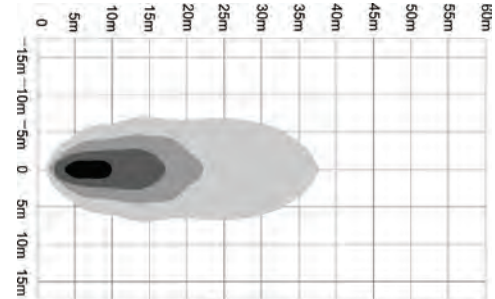
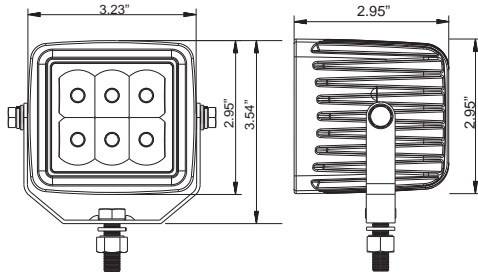

Part No.	Size	LED's	Amps	Lumens	Color	Base / Mount	Lead Length	Connection	Wt. (lbs.)	Cat.
1492237	3.23"	6	1.5	1380	Clear	SST	36"	Blunt Cut	1.5	562 (N)

2.875" Square LED Flood Light



- Recessed Mount

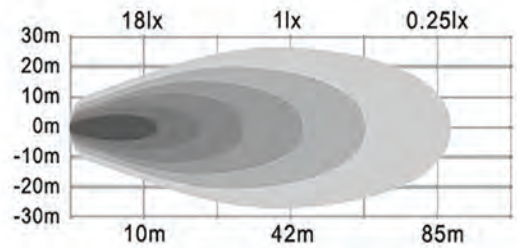
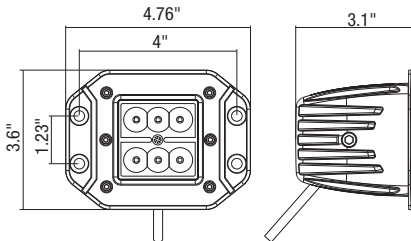

Part No.	Size	LED's	Amps	Lumens	Color	Base / Mount	Lead Length	Connection	Wt. (lbs.)	Cat.
NEW 1492138	2.875"	6	1.38	1620	Clear	12 mm stud	18"	Blunt Cut	1.37	562 (N)

2.875" Rectangular LED Flood Light



- Flat, tubular and angle mounting options included

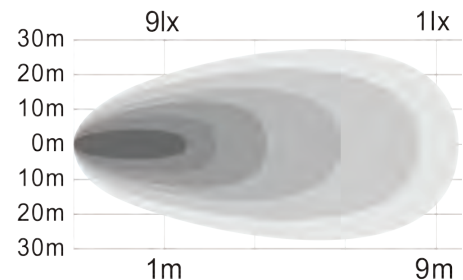
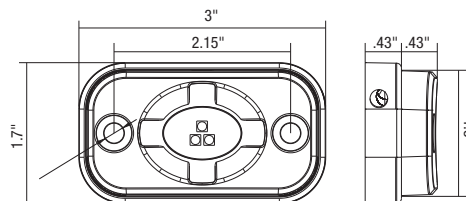

Part No.	Size	LED's	Amps	Lumens	Color	Housing	Lead Length	Connection	Wt. (lbs.)	Cat.
NEW 1492139	3" x 1-1/2"	3	0.34	1260	Clear	Black Aluminum	18"	Blunt Cut	0.32	562 (N)

LED Flood and Spot Lights

5.7" Rectangular LED Flood Light

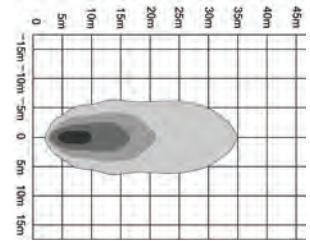
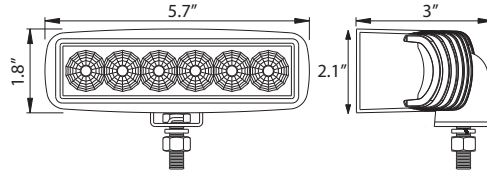

Part No.	Size	LED's	Amps	Lumens	Color	Base / Mount	Lead Length	Connection	Wt. (lbs.)	Cat.
1492135	5.7"	6	1.5	1350	Clear	SST	36"	Blunt Cut	1.6	562 (N)

4" x 6" Rectangular LED Flood Lights

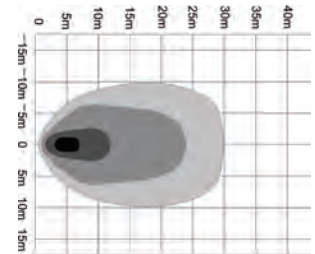
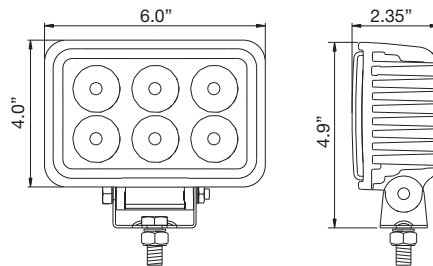

Part No.	Size	LED's	Amps	Lumens	Color	Base / Mount	Lead Length	Connection	Wt. (lbs.)	Cat.
1492118	4 x 6"	6	1.5	1350	Clear	SST	36"	Blunt Cut	1.75	562 (N)
1493118*	4 x 6"	6	1.5	1350	Clear	SST	36"	Blunt Cut	1.75	562 (N)

* White Housing

4" x 6" Rectangular LED Spot Lights

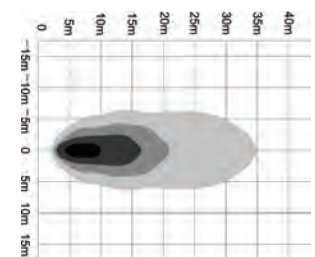
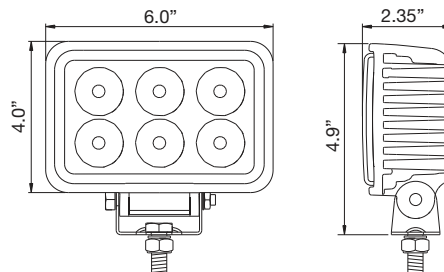

Part No.	Size	LED's	Amps	Lumens	Color	Base / Mount	Lead Length	Connection	Wt. (lbs.)	Cat.
1492218	4 x 6"	6	1.5	1350	Clear	SST	36"	Blunt Cut	1.75	562 (N)
1493218*	4 x 6"	6	1.5	1350	Clear	SST	36"	Blunt Cut	1.75	562 (N)

* White Housing

6.25" x 3.42" Rectangular Flood Light



- Includes 30° rubber offset mount

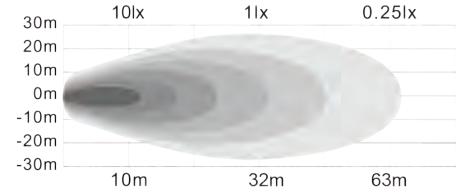
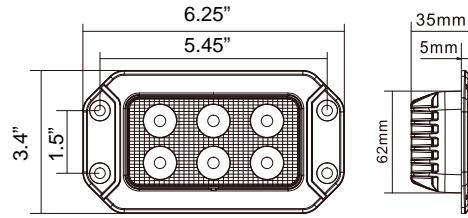

Part No.	Size	LED's	Amps	Lumens	Color	Base / Mount	Lead Length	Connection	Wt. (lbs.)	Cat.
1492191	6.25"L x 1.37"W x 3.42"T	6	0.75	1140	Clear	Recessed, Diecast	18"	Blunt Cut	1.2	562 (N)

5.9" x 4.8" Rectangular Flood Light

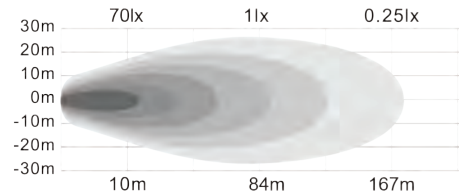
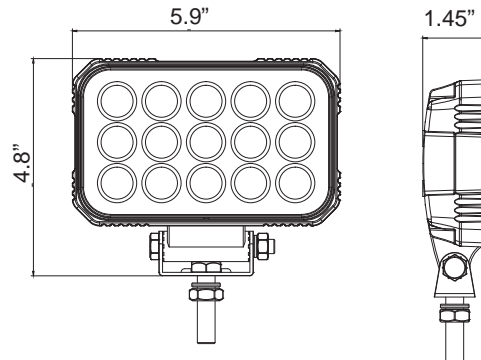

Part No.	Size	LED's	Amps	Lumens	Color	Base / Mount	Lead Length	Connection	Wt. (lbs.)	Cat.
1492190	5.9"L x 1.45" x 4.8"T	15	1.960	4050	Clear	M10-1.5, SST	18"	Blunt Cut	1.6	562 (N)

5.9" x 4.8" Rectangular Spot Light

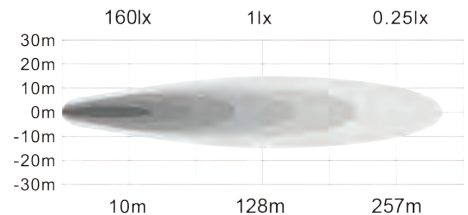
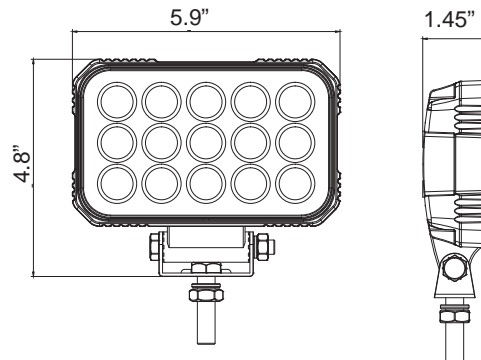

Part No.	Size	LED's	Amps	Lumens	Color	Base / Mount	Lead Length	Connection	Wt. (lbs.)	Cat.
1492290	5.9"L x 1.45" x 4.8"T	15	1.96	4050	Clear	SST	18"	Blunt Cut	1.6	562 (N)

Stainless Steel Mounts

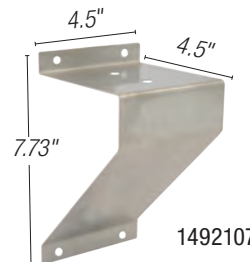
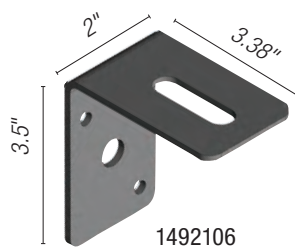

Part No.	Description	Wt. (lbs.)	Cat.
1492106	Stainless Steel Bracket for Flood & Spot Lights	0.47	562 (N)
1492107	Stainless Steel Bracket for Flood & Spot Lights	0.90	562 (N)

LED Flood Light Bars

10.125" LED Flood Light Bar

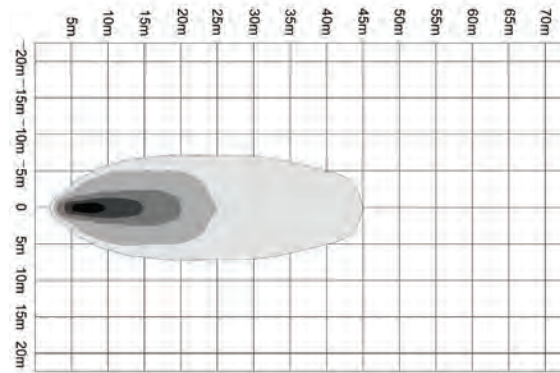
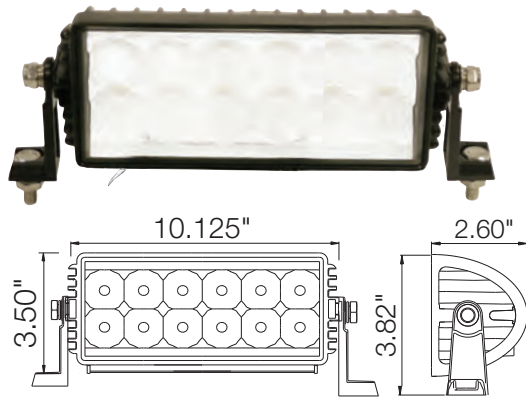

Part No.	Size	LED's	Amps	Lumens	Color	Base / Mount	Lead Length	Connection	Wt. (lbs.)	Cat.
1492140	10.125"	12	3	2700	Clear	Aluminum	36"	Blunt Cut	2.20	562 (N)

13.5" LED Flood Light Bar

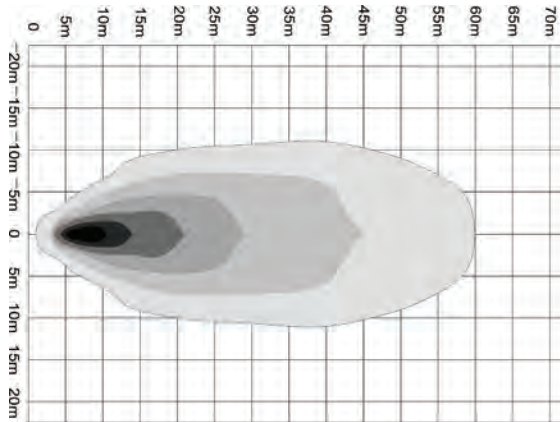
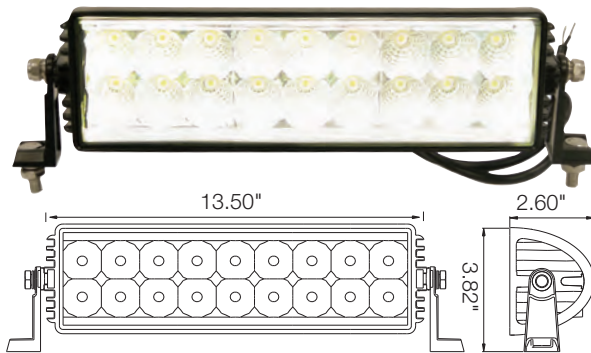

Part No.	Size	LED's	Amps	Lumens	Color	Base / Mount	Lead Length	Connection	Wt. (lbs.)	Cat.
1492141	13.5"	18	4	4050	Clear	Aluminum	36"	Blunt Cut	2.64	562 (N)

16.75" LED Flood Light Bar

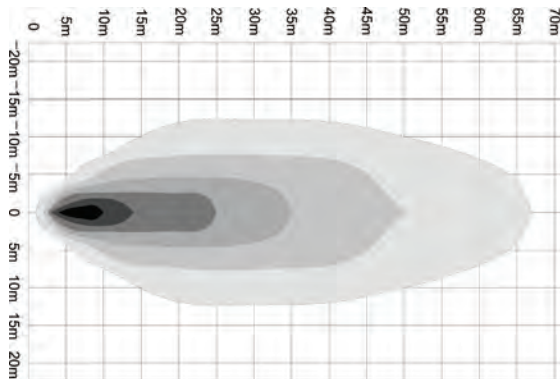
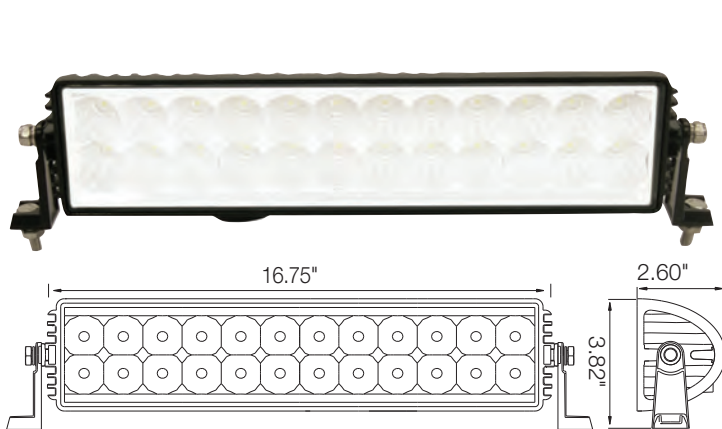

Part No.	Size	LED's	Amps	Lumens	Color	Base / Mount	Lead Length	Connection	Wt. (lbs.)	Cat.
1492142	16.75"	24	6	5400	Clear	Aluminum	36"	Blunt Cut	3.30	562 (N)

12.36" LED Combination Spot-Flood Light Bar

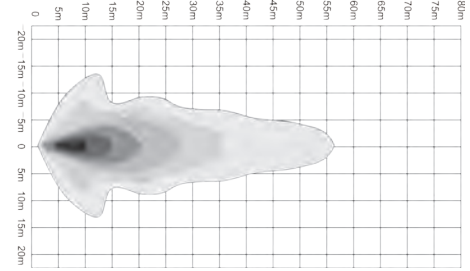
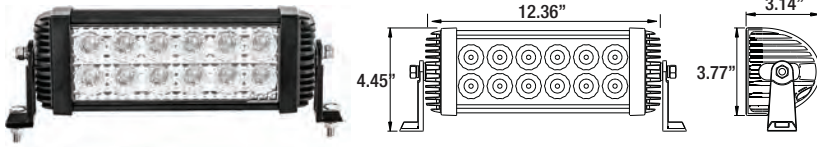

Part No.	Size	LED's	Amps	Lumens	Color	Base / Mount	Lead Length	Connection	Wt. (lbs.)	Cat.
1492150	12.36"	12	3	2700	Clear	Aluminum	36"	Blunt Cut	3.95	562 (N)

19.8" LED Combination Spot-Flood Light Bar

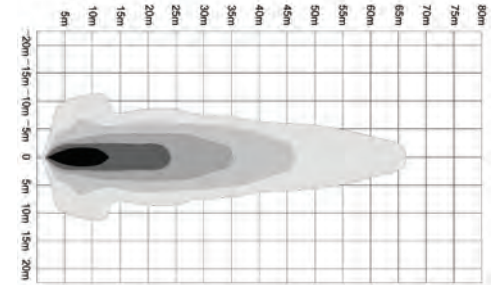
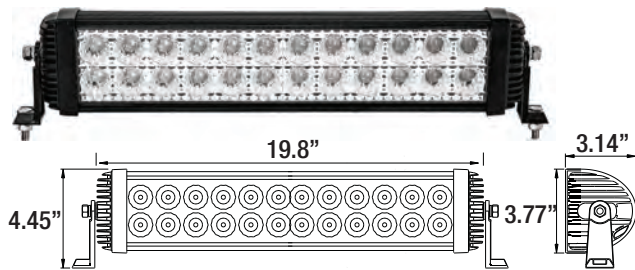

Part No.	Size	LED's	Amps	Lumens	Color	Base / Mount	Lead Length	Connection	Wt. (lbs.)	Cat.
1492151	19.8"	24	6	5400	Clear	Aluminum	36"	Blunt Cut	5.90	562 (N)

27.25" LED Combination Spot-Flood Light Bar

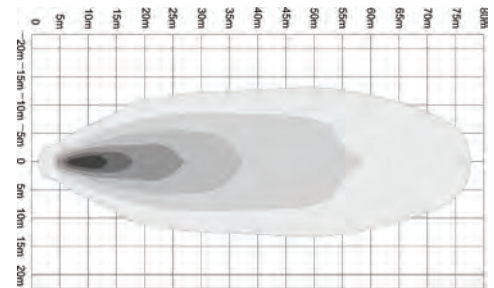
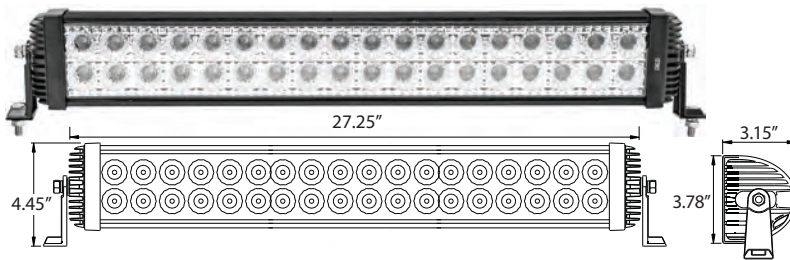

Part No.	Size	LED's	Amps	Lumens	Color	Base / Mount	Lead Length	Connection	Wt. (lbs.)	Cat.
1492152	27.25"	36	9	8100	Clear	Aluminum	36"	Blunt Cut	7.88	562 (N)

34.68" LED Combination Spot-Flood Light Bar

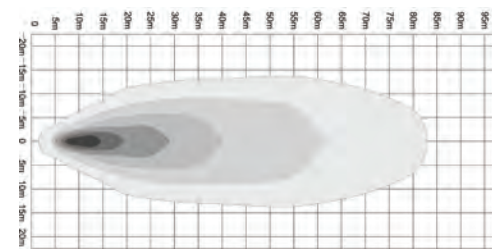
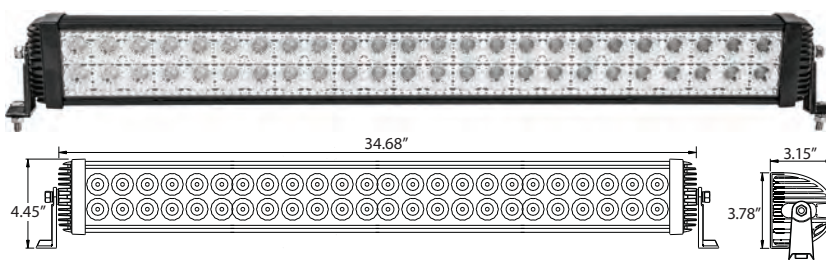

Part No.	Size	LED's	Amps	Lumens	Color	Base / Mount	Lead Length	Connection	Wt. (lbs.)	Cat.
1492153	34.68"	48	12	10800	Clear	Aluminum	36"	Blunt Cut	9.75	562 (N)

LED Spot-Flood Light Bars

8.11" LED Combination Spot-Flood Light Bar



• Available Q4 2016

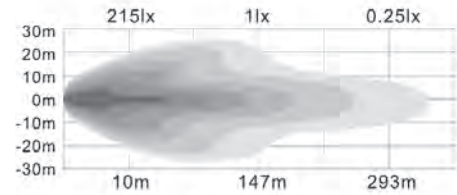
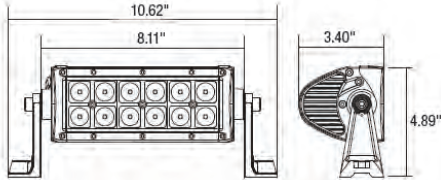

Combo Beam

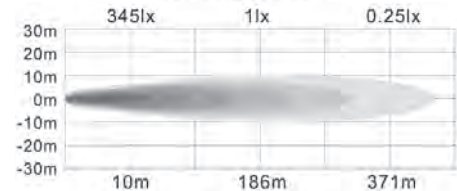

Spot Beam

Part No.	Size	LED's	Amps	Lumens	Color	Base / Mount	Lead Length	Connection	Wt. (lbs.)	Cat.
NEW 1492160	8.11"	12	2	3240	Clear	Aluminum	33.5"	Blunt Cut	3.34	562 (N)

14.09" LED Combination Spot-Flood Light Bar



• Available Q4 2016

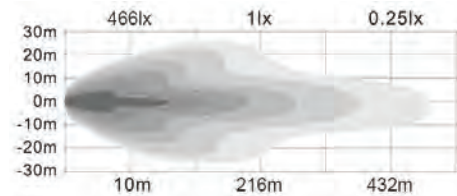
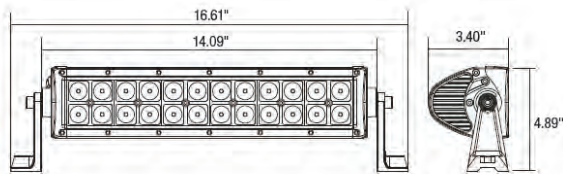

Combo Beam



Spot Beam

Part No.	Size	LED's	Amps	Lumens	Color	Base / Mount	Lead Length	Connection	Wt. (lbs.)	Cat.
NEW 1492161	14.09"	24	4.20	6480	Clear	Aluminum	33.5"	Blunt Cut	4.98	562 (N)

22.17" LED Combination Spot-Flood Light Bar



• Available Q4 2016

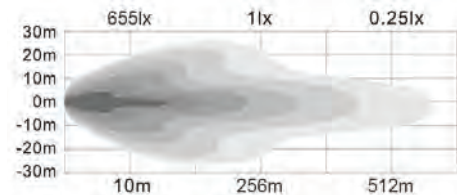
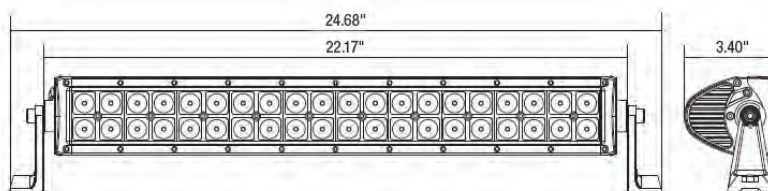

Combo Beam

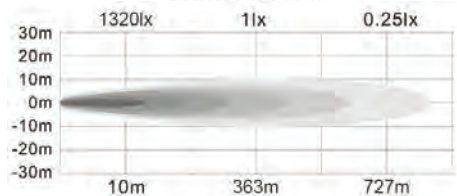

Spot Beam

Part No.	Size	LED's	Amps	Lumens	Color	Base / Mount	Lead Length	Connection	Wt. (lbs.)	Cat.
NEW 1492162	22.17"	40	8.20	10800	Clear	Aluminum	52.5"	Blunt Cut	7.34	562 (N)

32.20" LED Combination Spot-Flood Light Bar



• Available Q4 2016

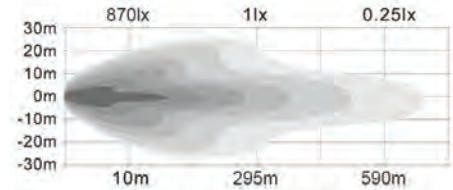
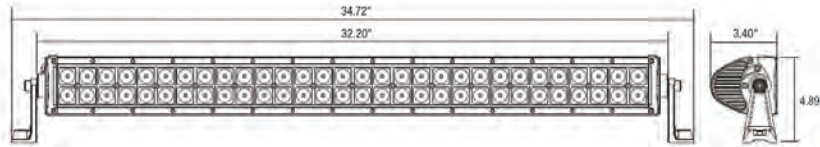

Combo Beam

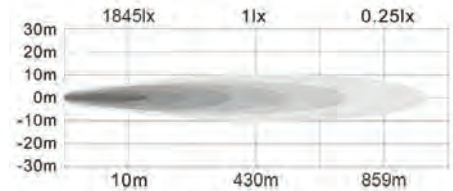

Spot Beam

Part No.	Size	LED's	Amps	Lumens	Color	Base / Mount	Lead Length	Connection	Wt. (lbs.)	Cat.
NEW 1492163	32.20"	60	12.00	16200	Clear	Aluminum	52.5"	Blunt Cut	10.15	562 (N)

50.12" LED Combination Spot-Flood Light Bar



• Available Q4 2016

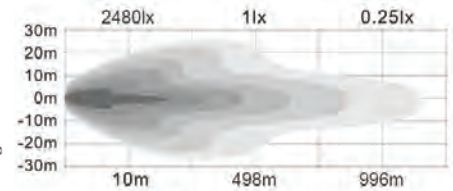
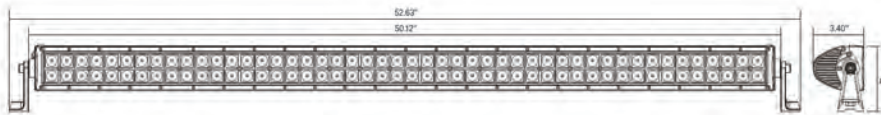

Combo Beam



Spot Beam

Part No.	Size	LED's	Amps	Lumens	Color	Base / Mount	Lead Length	Connection	Wt. (lbs.)	Cat.
NEW 1492165	50.12"	96	16.60	25920	Clear	Aluminum	52.5"	Blunt Cut	15.42	562 (N)

14.09" LED Curved Combination Spot-Flood Light Bar



• Available Q4 2016

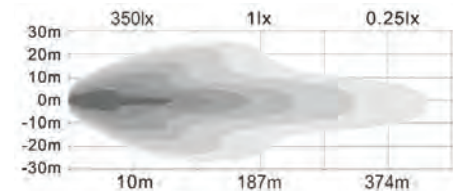
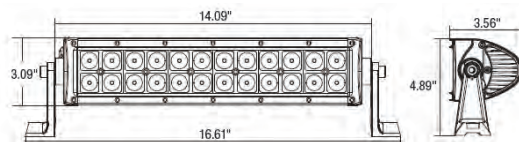

Combo Beam

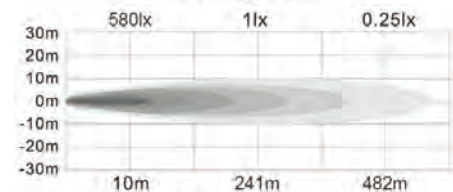

Spot Beam

Part No.	Size	LED's	Amps	Lumens	Color	Base / Mount	Lead Length	Connection	Wt. (lbs.)	Cat.
NEW 1492171	14.09"	24	4.20	6480	Clear	Aluminum	33.5"	Blunt Cut	4.93	562 (N)

LED Spot-Flood Light Bars

22.32" LED Curved Combination Spot-Flood Light Bar



• Available Q4 2016

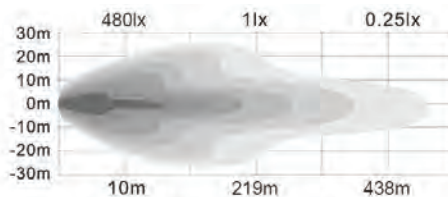
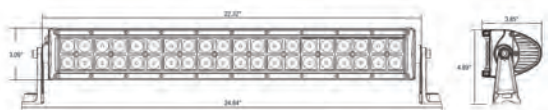

Combo Beam



Spot Beam

Part No.	Size	LED's	Amps	Lumens	Color	Base / Mount	Lead Length	Connection	Wt. (lbs.)	Cat.
NEW 1492172	22.32"	40	8.20	10800	Clear	Aluminum	52.5"	Blunt Cut	7.29	562 (N)

50.12" LED Curved Combination Spot-Flood Light Bar



• Available Q4 2016

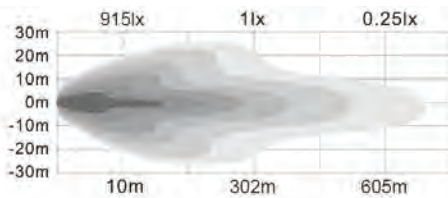
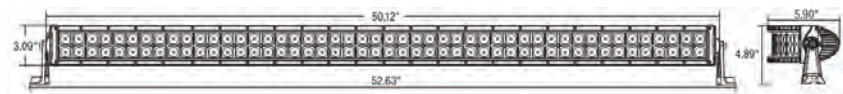

Combo Beam

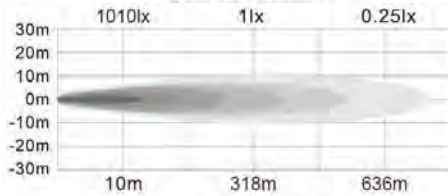

Spot Beam

Part No.	Size	LED's	Amps	Lumens	Color	Base / Mount	Lead Length	Connection	Wt. (lbs.)	Cat.
NEW 1492175	50.12"	96	16.60	25920	Clear	Aluminum	52.5"	Blunt Cut	15.51	562 (N)

20.63" LED Combination Spot-Flood Light Bar



• Available Q4 2016

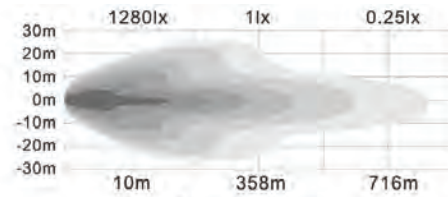
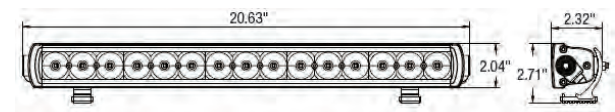

Combo Beam

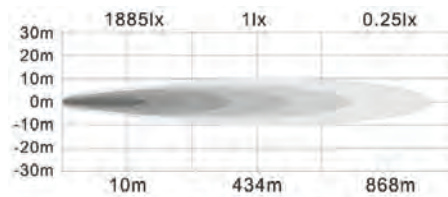

Spot Beam

Part No.	Size	LED's	Amps	Lumens	Color	Base / Mount	Lead Length	Connection	Wt. (lbs.)	Cat.
NEW 1492182	20.63"	15	2.80	4050	Clear	Aluminum	30.5"	Blunt Cut	3.7	562 (N)

31.97" LED Combination Spot-Flood Light Bar



• Available Q4 2016

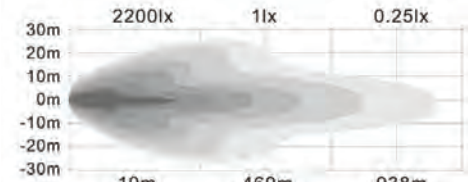

Combo Beam

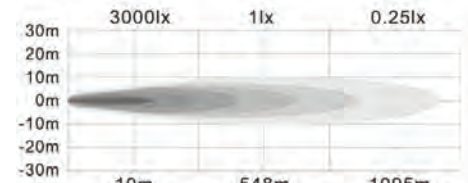

Spot Beam

Part No.	Size	LED's	Amps	Lumens	Color	Base / Mount	Lead Length	Connection	Wt. (lbs.)	Cat.
NEW 1492183	31.97"	24	4.55	6480	Clear	Aluminum	30.5"	Blunt Cut	5.45	562 (N)

39.53" LED Combination Spot-Flood Light Bar



• Available Q4 2016

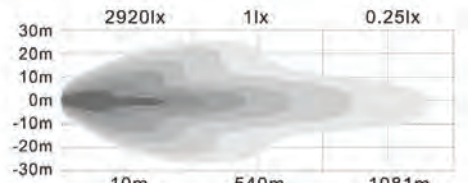

Combo Beam

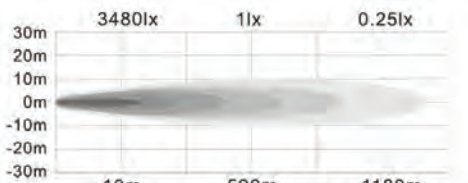

Spot Beam

Part No.	Size	LED's	Amps	Lumens	Color	Base / Mount	Lead Length	Connection	Wt. (lbs.)	Cat.
NEW 1492184	39.53"	30	5.78	8100	Clear	Aluminum	30.5"	Blunt Cut	6.62	562 (N)

50.87" LED Combination Spot-Flood Light Bar



• Available Q4 2016



Combo Beam



Spot Beam

Part No.	Size	LED's	Amps	Lumens	Color	Base / Mount	Lead Length	Connection	Wt. (lbs.)	Cat.
NEW 1492185	50.87"	39	7.60	10530	Clear	Aluminum	30.5"	Blunt Cut	8.8	562 (N)

Incandescent Flood and Interior Lights, LED Interior Lights

5" Sealed Rubber Incandescent Flood Light

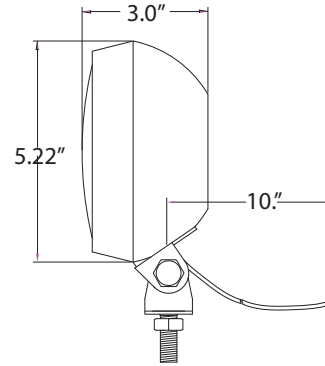
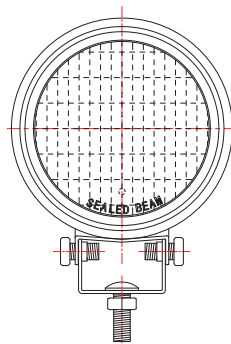

Part No.	Size	Amps	Watts	Color	Base / Mount	Lead Length	Connection	Std. Qty.	Wt. (lbs.)	Cat.
1492100	5"	2.92	35	Clear	Zinc	10"	Blunt Cut	1	2.64	562 (N)

5" Round Incandescent Interior Dome Light

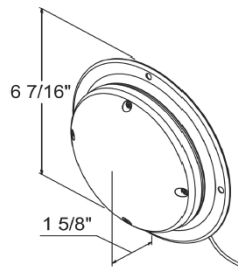

Part No.	Size	Amps	Color	Bulb	On-Off Switch	Std. Qty.	Wt. (lbs.)	Cat.
5625030	4.6"	2.2	Clear	1156	Yes	1	0.5	562 (N)

5" Round LED Interior Dome Light

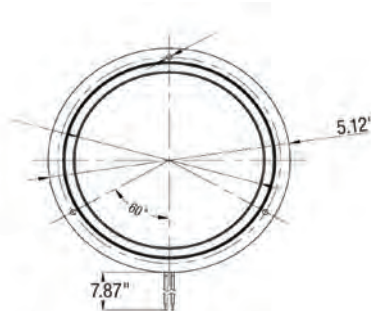

- 12-24 VDC
- 1.5A

Part No.	Size	LED's	Lens Color	Connection	Lumens	Mounting	Std. Qty.	Wt. (lbs.)	Cat.
NEW 5625336	5.1"	36	Clear	8" Blunt Cut	2200	Surface	1	0.39	562 (N)

LED Interior Dome Lights

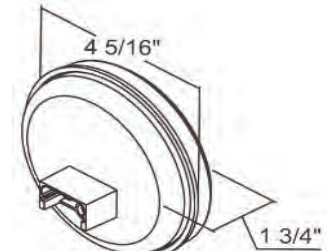
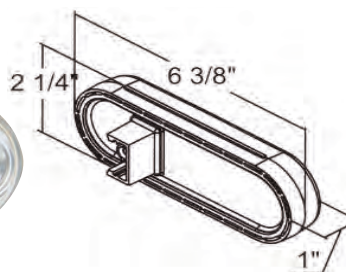

Part No.	Size	LED's	Lens Color	Connection	Lumens	Mounting	Amp	Std. Qty.	Wt. (lbs.)	Cat.
5626352	6"	10	Clear	PL-3 Connection	80	Grommet	.221	10	0.37	562 (N)
5624352	4"	10	Clear	PL-3 Connection	80	Grommet	.221	10	0.34	562 (N)

See mounting grommets on page 11

LED Strip Lights w/3M™ Adhesive Back

- Commercial grade housing
- Wired at both ends
- End caps and mounting clips included
- Can be cut every 3 LEDs



Part No.	Size	LED's	Amps	Lumens	Color	Connection	Std. Qty.	Wt. (lbs.)	Cat.
5621827	18"	27	0.41	360	Clear, Warm	Blunt Cut, Both Ends	1	0.31	562 (N)
5621928	18"	27	0.41	360	Clear, Cool	Blunt Cut, Both Ends	1	0.31	562 (N)
5622436	24"	36	0.54	470	Clear, Warm	Blunt Cut, Both Ends	1	0.35	562 (N)
5622537	24"	36	0.54	470	Clear, Cool	Blunt Cut, Both Ends	1	0.35	562 (N)
5622638	24"	36	0.54	470	Red	Blunt Cut, Both Ends	1	0.35	562 (N)
5622739	24"	36	0.54	470	Blue	Blunt Cut, Both Ends	1	0.35	562 (N)
5623654	36'	54	0.81	710	Clear, Warm	Blunt Cut, Both Ends	1	0.40	562 (N)
5623755	36'	54	0.81	710	Clear, Cool	Blunt Cut, Both Ends	1	0.40	562 (N)
5624872	48"	72	1.12	940	Clear, Warm	Blunt Cut, Both Ends	1	0.44	562 (N)
5624973	48"	72	1.12	940	Clear, Cool	Blunt Cut, Both Ends	1	0.44	562 (N)
5625074	48"	72	1.12	940	Red	Blunt Cut, Both Ends	1	0.44	562 (N)
5625175	48"	72	1.12	940	Blue	Blunt Cut, Both Ends	1	0.44	562 (N)
5626090	60"	90	1.30	1180	Clear, Warm	Blunt Cut, Both Ends	1	0.55	562 (N)
5626090	60"	90	1.30	1180	Clear, Cool	Blunt Cut, Both Ends	1	0.55	562 (N)
5626191	60"	90	1.30	1175	Amber	Blunt Cut, Both Ends	1	0.55	562 (N)
56296144	96"	144	2.00	2160	Clear, Warm	Blunt Cut, Both Ends	1	0.88	562 (N)
56297145	96"	144	2.00	2160	Clear, Cool	Blunt Cut, Both Ends	1	0.88	562 (N)
56298146	96"	144	2.00	1880	Amber	Blunt Cut, Both Ends	1	0.88	562 (N)
562109166	108"	165	3.00	2400	Clear, Cool	Blunt Cut, Both Ends	1	1.37	562 (N)
562133202	132"	201	4.00	3000	Clear, Cool	Blunt Cut, Both Ends	1	1.37	562 (N)

* Special lengths and wire connectors available upon request *

Strobe Controller



- 15 Watts MAX (1.25A@12V)
- Will not work with lengths exceeding 48"
- Mounts with included 3M adhesive foam tape
- Make connections quick with included quick splice connectors
- Works with steady burning 12VDC light(s) up to 1.25A

Part No.	Size	Amps	Operating Temp	Connection	Std. Qty.	Wt. (lbs.)	Cat.
5621001	1" x 1-1/2"	1.25	-22 to 176	6" Lead	1	0.07	562 (N)

LED Strip, Projector and Rope Lights

LED Strip Lights with Inline Switch



Part No.	Size	LED's	Amps	Lumens	Color	Connection	Std. Qty.	Wt. (lbs.)	Cat.
56218270	18"	27	0.41	360	Clear, Warm	Blunt Cut, Both Ends	1	0.34	562 (N)
56224360	24"	36	0.54	470	Clear, Warm	Blunt Cut, Both Ends	1	0.39	562 (N)
56236540	36"	54	0.81	710	Clear, Warm	Blunt Cut, Both Ends	1	0.43	562 (N)
56248720	48"	72	1.125	940	Clear, Warm	Blunt Cut, Both Ends	1	0.47	562 (N)

Switch comes w/3M adhesive foam tape pre-applied

4.4" LED Projector Light



• Ideal for cab steps and perimeter ground lighting

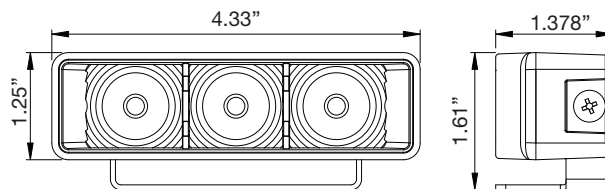

Part No.	Size	LED's	Amps	Lumens	Color	Base / Mount	Lead Length	Connection	Std. Qty.	Wt. (lbs.)	Cat.
5624433	4.4"	3	.30	120	Clear	Aluminum/SS Bracket	36"	Blunt Cut	1	0.37	562 (N)

LED Rope Light w/Connections and Mounts



- Mounting hardware and Connections included
- Can be cut every 3 LEDs



End Cap Clip Power Cable

Part No.	Size	LED's	Amps	Lumens	Color	Base / Mount	Connection	Std. Qty.	Wt. (lbs.)	Cat.
5625576	52.5'	576	3.8	48-60/ft.	Clear	Clips	Plug	1	6	562 (N)